



User Manual
Model N901
Hydrocarbon Analyzer



© Teledyne API (TAPI)
9970 Carroll Canyon Road
San Diego, California
92131-1106
USA

Toll-free Phone: +1 800-324-5190
Phone: +1 858-657-9800
Fax: +1 858-657-9816
Email: api-sales@teledyne.com
Website: <http://www.teledyne-api.com>

Copyright 2021-2022
Teledyne API

092910910B DCN8628



NOTICE OF COPYRIGHT

© 2021-2022 Teledyne API (TAPI). All rights reserved.

TRADEMARKS

All trademarks, registered trademarks, brand names or product names appearing in this document are the property of their respective owners and are used herein for identification purposes only.

SAFETY MESSAGES

Important safety messages are provided throughout this manual for the purpose of avoiding personal injury or instrument damage. Please read these messages carefully. Each safety message is associated with a safety alert symbol and is placed throughout this manual; the safety symbols are also located inside the instrument. It is imperative that you pay close attention to these messages, the descriptions of which are as follows:



WARNING: Electrical Shock Hazard



HAZARD: Strong oxidizer



GENERAL WARNING/CAUTION: Read the accompanying message for specific information.



CAUTION: Hot Surface Warning



Do Not Touch: Touching some parts of the instrument without protection or proper tools could result in damage to the part(s) and/or the instrument.



Technician Symbol: All operations marked with this symbol are to be performed by qualified maintenance personnel only.



Electrical Ground: This symbol inside the instrument marks the central safety grounding point for the instrument.

CAUTION

This product should only be installed, commissioned, and used strictly for the purpose and in the manner described in this manual. If you improperly install, commission, or use this instrument in any manner other than as instructed in this manual or by our Technical Support team, unpredictable behavior could ensue with possible hazardous consequences.



Such risks, whether during installation and commission or caused by improper installation/commissioning/use, and their possible hazardous outcomes include but are not limited to:

RISK	HAZARD
Liquid or dust/debris ingress	Electrical shock hazard
Improper or worn power cable	Electrical shock or fire hazard
Excessive pressure from improper gas bottle connections	Explosion and projectile hazard
Sampling combustible gas(es)	Explosion and fire hazard
Improper lift & carry techniques	Personal injury

Note that the safety of a system that may incorporate this product is the end user's responsibility.

For Technical Assistance regarding the use and maintenance of this instrument or any other Teledyne API product, contact Teledyne API's Technical Support Department:

Telephone: +1 800-324-5190
 Email: api-techsupport@teledyne.com

or access any of the service options on our website at <http://www.teledyne-api.com/>

CONSIGNES DE SÉCURITÉ

Des consignes de sécurité importantes sont fournies tout au long du présent manuel dans le but d'éviter des blessures corporelles ou d'endommager les instruments. Veuillez lire attentivement ces consignes. Chaque consigne de sécurité est représentée par un pictogramme d'alerte de sécurité; ces pictogrammes se retrouvent dans ce manuel et à l'intérieur des instruments. Les symboles correspondent aux consignes suivantes:



AVERTISSEMENT Risque de choc électrique



DANGER: Oxydant puissant



AVERTISSEMENT GÉNÉRAL / MISE EN GARDE: Lire la consigne complémentaire pour des renseignements spécifiques



MISE EN GARDE: Surface chaude



Ne pas toucher: Toucher à certaines parties de l'instrument sans protection ou sans les outils appropriés pourrait entraîner des dommages aux pièces ou à l'instrument.



Pictogramme «technicien»: Toutes les opérations portant ce symbole doivent être effectuées uniquement par du personnel de maintenance qualifié.



Mise à la terre: Ce symbole à l'intérieur de l'instrument détermine le point central de la mise à la terre sécuritaire de l'instrument.

MISE EN GARDE

Ce produit ne doit être installé, mis en service et utilisé qu'aux fins et de la manière décrites dans le présent manuel. Si vous installez, mettez en service ou utilisez cet instrument de manière incorrecte autre que celle indiquée dans ce manuel ou sous la direction de notre équipe de soutien technique, un comportement imprévisible pourrait entraîner des conséquences potentiellement dangereuses.

Ce qui suit est une liste, non exhaustive, des risques et résultats dangereux possibles associés avec une mauvaise utilisation, une mise en service incorrecte, ou causés mauvaise commission.



RISQUE	DANGER
Pénétration de liquide ou de poussière/débris	Risque de choc électrique
Câble d'alimentation incorrect, endommagés ou usé	Choc électrique ou risque d'incendie
Pression excessive due à des connexions de bouteilles de gaz incorrectes	Risque d'explosion et d'émission de projectile
Échantillonnage de gaz combustibles	Risque d'explosion et d'incendie
Techniques de manutention, soulevage et de transport inappropriées	Blessure corporelle

Notez que la sécurité d'un système qui peut incorporer ce produit est la responsabilité de l'utilisateur final.

WARRANTY

WARRANTY POLICY (02024J)

Teledyne API (TAPI), a business unit of Teledyne Instruments, Inc., provides that: Prior to shipment, TAPI equipment is thoroughly inspected and tested. Should equipment failure occur, TAPI assures its customers that prompt service and support will be available. (For the instrument-specific warranty period, please refer to the “Limited Warranty” section in the Terms and Conditions of Sale on our website at: http://www.teledyne-api.com/terms_and_conditions.asp).

COVERAGE

After the warranty period and throughout the equipment lifetime, TAPI stands ready to provide on-site or in-plant service at reasonable rates similar to those of other manufacturers in the industry. All maintenance and the first level of field troubleshooting are to be performed by the customer.

NON-TAPI MANUFACTURED EQUIPMENT

Equipment provided but not manufactured by TAPI is warranted and will be repaired to the extent and according to the current terms and conditions of the respective equipment manufacturer’s warranty.

PRODUCT RETURN

All units or components returned to Teledyne API should be properly packed for handling and returned freight prepaid to the nearest designated Service Center. After the repair, the equipment will be returned, freight prepaid.

The complete Terms and Conditions of Sale can be reviewed at http://www.teledyne-api.com/terms_and_conditions.asp

CAUTION – Avoid Warranty Invalidation



Failure to comply with proper anti-Electro-Static Discharge (ESD) handling and packing instructions and Return Merchandise Authorization (RMA) procedures when returning parts for repair or calibration may void your warranty. For anti-ESD handling and packing instructions please refer to the manual, Fundamentals of ESD, PN 04786, in its “Packing Components for Return to Teledyne API’s Customer Service” section. The manual can be downloaded from our website at <http://www.teledyne-api.com>. RMA procedures can also be found on our website.

ABOUT THIS MANUAL

Note

We recommend that all users read this manual in its entirety before operating the instrument.

CONVENTIONS USED

In addition to the safety symbols as presented in the *Safety Messages* page, this manual provides *special notices* related to the careful and effective use of the instrument and related, pertinent information.

ATTENTION

COULD DAMAGE INSTRUMENT AND VOID WARRANTY
This special notice provides information to avoid damage to your instrument and possibly invalidate the warranty.

Important

IMPACT ON READINGS OR DATA
Provides information about that which could either affect accuracy of instrument readings or cause loss of data.

Note

Provides information pertinent to the proper care, operation or maintenance of the instrument or its parts.

TABLE OF CONTENTS

Safety Messages.....	ii
Warranty.....	vi
Table of Contents.....	viii
List of Figures.....	xi
List of Tables.....	xi
1. INTRODUCTION, SPECIFICATIONS, APPROVALS, & COMPLIANCE.....	13
1.1. Specifications.....	13
1.2. Compliance and Certifications.....	14
2. GETTING STARTED.....	15
2.1. Unpacking.....	15
2.1.1. Ventilation Clearance.....	16
2.2. Instrument Layout.....	17
2.2.1. Front Panel.....	17
2.2.2. Rear Panel.....	18
2.2.3. Internal Chassis.....	20
2.3. Connections and Startup.....	21
2.3.1. Electrical Connections.....	21
2.3.1.1. Connecting Power.....	21
2.3.1.2. Connecting Analog Outputs Option.....	22
2.3.1.3. Connecting the Digital I/O Expansion Board Option.....	23
2.3.1.4. Connecting Communications Interfaces.....	24
2.3.2. Pneumatic Connections.....	25
2.3.2.1. Critical Tubing, Pressure, Venting and Exhaust Requirements.....	26
2.3.2.2. Basic Pneumatic Connections.....	27
2.3.2.3. Basic Connections from Calibrator.....	27
2.3.3. Pneumatic Flow Diagrams.....	29
2.3.4. Startup, Functional Checks and Calibration.....	31
2.3.4.1. Power Status.....	31
2.3.4.2. Startup.....	32
2.3.4.3. Alerts: Warnings and Other Messages.....	33
2.3.4.4. Functional Checks.....	34
2.4. Menu Overview.....	35
2.4.1. Home Page.....	36
2.4.2. Dashboard.....	38
2.4.3. Alerts.....	39
2.4.4. Calibration.....	40
2.4.5. Utilities.....	41
2.4.6. Setup.....	41
2.5. Setup Menu: Features/Functions Configuration.....	42
2.5.1. Setup>Data Logging (Data Acquisition System, DAS).....	42
2.5.1.1. Configuring Trigger Types: Periodic.....	44
2.5.1.2. Configuring Trigger Types: Conditional.....	45
2.5.1.3. Downloading DAS (Data Acquisition System) Data.....	45
2.5.2. Setup>Events.....	46
2.5.2.1. Editing or Deleting Events.....	47
2.5.2.2. Using Events as Triggers for Data Logging.....	48
2.5.3. Setup>Dashboard.....	48
2.5.4. Setup>AutoCal (with Valve Option).....	48
2.5.5. Setup>Vars.....	49
2.5.6. Setup>GC Gas Config.....	51
2.5.7. Setup>Homescreen.....	52
2.5.8. Setup>Digital Outputs (Option).....	53

2.5.9. Setup>Instrument.....	54
2.5.10. Setup>Comm (Communications).....	54
2.5.10.1. COM1	54
2.5.10.2. TCP Port1.....	55
2.5.10.3. TCP Port2.....	55
2.5.10.4. Network Settings	56
2.6. Transferring Configuration to Other Instruments	57
3. COMMUNICATIONS AND REMOTE OPERATION	58
3.1. Serial Communication	58
3.2. Ethernet.....	58
3.3. NumaView™ Remote.....	58
4. CALIBRATION	59
4.1. Important Precalibration Information	59
4.1.1. Calibration Requirements	59
4.1.2. Zero Air	60
4.1.3. Calibration (Span) Gas	60
4.1.4. Data Recording Devices	61
4.2. Calibration Procedures.....	61
4.2.1. Calibration and Check Procedures for Basic Configuration	61
4.2.1.1. O ₂ Calibration	62
4.2.1.2. CH ₄ Calibration	63
4.2.1.3. NMHC Calibration.....	64
4.2.2. Calibration and Check Procedures with Span Cal Valve and Digital Expansion Board Options Installed	66
4.3. Automatic Span Cal Check (Auto Cal).....	66
5. MAINTENANCE AND SERVICE	68
5.1. Maintenance Schedule.....	68
5.2. Operational Health Checks	69
5.3. Software/Firmware Updates.....	69
5.3.1. Remote Updates	69
5.3.2. Manual Reload/Update Procedures.....	70
5.4. Time Zone Changes.....	71
5.5. Service and Troubleshooting	72
5.5.1. Fault Diagnosis with Alerts.....	73
5.5.2. Using the Diagnostic Signal I/O Functions	73
5.5.3. Fault Diagnosis with LEDs	73
5.5.4. Calibration Problems.....	74
5.5.4.1. Absence of Analyzer Response to Sample Gas	74
5.5.4.2. Unstable Zero and Span.....	75
5.5.4.3. Inability to Span - Deactivated SPAN Button	75
5.5.5. Other Possible Performance Problems	75
5.5.5.1. Trouble Igniting the Flame Ionization Detector (FID)	75
5.5.5.2. Negative Chromatograph Peaks	76
5.5.5.3. Slow Response.....	76
5.5.6. Subsystem Check for Troubleshooting.....	76
5.5.6.1. AC Main Power.....	77
5.5.6.2. LCD/Display Module.....	77
5.5.6.3. RS-232 Communications.....	77
5.5.7. Service Procedures.....	78
5.5.7.1. Flow Adjustment (Calibration) Procedures.....	78
5.5.7.2. Column Maintenance.....	79
5.5.7.3. Filter Element Replacement.....	80
5.5.7.4. Pump Replacement.....	80
5.5.7.5. Fuse Replacement Procedure.....	81
5.6. Technical Assistance	82



6. PRINCIPLES OF OPERATION	83
6.1. Pneumatic Operation	84
6.2. Electronic Operation.....	84
6.2.1. Modules.....	84
6.2.2. Power Switches.....	85

LIST OF FIGURES

Figure 2-1. Front Panel Layout	17
Figure 2-2. Rear Panel Layout.....	18
Figure 2-3. Internal Chassis Layout.....	20
Figure 2-4. Analog Outputs Connectors Panel Option	22
Figure 2-5. Digital I/O Connector Panel Option	23
Figure 2-6. Mainboard JP1 Location and Pin Arrangements.....	24
Figure 2-7. Gas Line Connections from Calibrator – Basic Configuration	27
Figure 2-8. Gas Line Connections without Calibrator	28
Figure 2-9. Pneumatic Flow Diagram of Sample Capture Cycle	29
Figure 2-10. Pneumatic Flow Diagram of Measure Cycle	29
Figure 2-11. Pneumatic Flow Diagram of Sample Capture Cycle with Span Valve Option	30
Figure 2-12. Pneumatic Flow Diagram of Measure Cycle with Span Valve Option.....	30
Figure 2-13. Status Screens at Startup.....	32
Figure 2-14. Home Page.....	32
Figure 2-15. Viewing Active Alerts Page.....	33
Figure 2-16. Sample Dashboard Page	34
Figure 2-17. User Interface Orientation	36
Figure 2-18. Concentration Graph (top) and Meter Graph (bottom).....	37
Figure 2-19. Parameter Graph from Dashboard Page	38
Figure 2-20. Active Alerts Page	39
Figure 2-21. Active Alerts Cleared	40
Figure 2-22. Utilities>Alerts Log of Active and Past Alerts and Events	40
Figure 2-23. Datalog Configuration, New Log Page	42
Figure 2-24. Datalog Configuration, Existing Log	42
Figure 2-25. Creating a New Data Log	43
Figure 2-26. Datalog Periodic Trigger Configuration	44
Figure 2-27. Datalog - Conditional Trigger Configuration	45
Figure 2-28. DAS Download Page.....	45
Figure 2-29. Example Events List	46
Figure 2-30. Event Configuration	46
Figure 2-31. Configured Event Sample.....	47
Figure 2-32. Edit or Delete an Event.....	47
Figure 2-33. Dashboard Display and Configuration.....	48
Figure 2-34. GC Gas Configuration	51
Figure 2-35. Homescreen Configuration.....	52
Figure 2-36. Digital Outputs Setup.....	53
Figure 2-37. Communications Configuration, Network Settings.....	56
Figure 2-38. Configuration Transfer.....	57
Figure 4-1. Reconfiguration when Nitrogen Used as Span Gas.....	60
Figure 4-2. Auto Cal Page.....	66
Figure 5-1: Report Generation Page.....	69
Figure 5-2. Remote Update Page	70
Figure 5-3. Manual Update Page (and other utilities).....	70
Figure 5-4. Time Zone Change Requirements	71
Figure 5-5. Mainboard.....	74
Figure 5-6. Flow Adjust Menu	79
Figure 5-7. Fuse Access	81
Figure 6-1. Chromatograph Example of THC, O ₂ , and CH ₄ Peaks	83

LIST OF TABLES

Table 1-1. Specifications.....	13
Table 2-1. Ventilation Clearance.....	16

Table 2-2. Rear Panel Description	19
Table 2-3. Analog Output Pin Assignments	22
Table 2-4. Digital Input/Output Pin Assignments	23
Table 2-5. JP1 Configurations for Serial Communication	25
Table 2-6. Menu Overview	35
Table 2-7. Utilities Submenu Descriptions	41
Table 2-8. Key Variables with Default Values and Descriptions	49
Table 2-9. Common Variables with Descriptions	50
Table 2-10. Setup>Instrument Menu	54
Table 2-11. COM1 Setup	54
Table 2-12. LAN/Ethernet Configuration Properties	56
Table 3-1. Ethernet Status Indicators	58
Table 4-1. Auto Cal Programming Sequence Execution	67
Table 5-1. Maintenance Schedule	68

1. INTRODUCTION, SPECIFICATIONS, APPROVALS, & COMPLIANCE

Teledyne API’s Model N901 Hydrocarbon Analyzer is a high-sensitivity instrument that uses Gas Chromatography (GC) with a Flame Ionization Detector (FID) to measure the concentration of Total Hydrocarbons (THC) and Methane (CH₄) in air, and calculates the difference to provide an accurate non-Methane (non-CH₄) concentration reading. The range and performance of the N901 are tuned specifically for use in ambient air quality monitoring assessments.

The Model N901 is designed for simple operation and maintenance with a modular hardware and electronics architecture. A long-life stainless-steel fritted filter is used at the sample intake to effectively remove particulate matter without introducing any gas-phase measurement artifacts. Instrument operation, calibration functions and data handling are all automated and controlled using the internal NumaView™ Software (NVS) interface, without the need for an external PC. Additionally, NumaView™ Remote Software can also be used for remote communications, for access to the graphical user interface, for downloading data, and for other operations.

The section on Principles of Operation (Section 6) provides more information on the method and the functional details.

1.1. SPECIFICATIONS

Table 1-1. Specifications

Parameter	Description	
Ranges (Methane)	Min: 0-5 ppm Max: 0-1,000 ppm	
Measurement Units	ppm, ppb	
Zero Drift	Zero baseline performed once per cycle	
Span Drift (24 hr)	< 1% of full scale	
Lower Detectable Limit	<25 ppb (Methane); <25 ppb (Propane)	
Linearity	<1% of full scale	
Precision	<1% of reading or 0.05 ppm (whichever is greater)	
Sample Flow Rate	60 cc/min ±10%	
Carrier Gas	50 to 70 psi, N2 UHP Grade (99.999% purity), consumption 20 cc/min	
Fuel Gas	50 psi ± 5%, H2 UHP Grade (99.999% purity), consumption 35 cc/min	
FID Air	50 psi ± 5%, HC Free clean air, consumption 350 cc/min	
Auxiliary Air	70 psi ± 5%, Clean Dry Air, consumption 1 cc/actuation	
AC Power	Rating	Typical Power Consumption
	100-120 V~, 60 Hz, 3 A	130 W
	220-240 V~, 50/60 Hz, 3 A	135 W
Power Entry Module Fuse	5.0 A, 250 V AC, 5 mm x 20 mm, SLO-BLO	

Parameter	Description
Communications	
Standard I/O	1 Ethernet (TCP/IP) 1 RS-232 2 front panel USB device ports
Optional I/O	Universal Analog Output Board (all user-definable): 4 x isolated voltage outputs (5 V, 10 V) 3 x individually isolated current outputs (4-20 mA) Digital I/O Expansion Board includes: 3 x isolated digital input controls (fixed) 5 x isolated digital output controls (user-definable) 3 x form C relay alarm outputs (user-definable)
Operating Temperature	5-40 °C
Humidity Range	0-95% RH, Non-Condensing
Dimensions HxWxD	7" x 17" x 23.5" (178 x 432 x 597 mm)
Weight	35 lbs (16 kg)
Environmental Conditions	<ul style="list-style-type: none"> • Installation Category (Over Voltage Category) II Pollution Degree 2 • Intended for Indoor Use Only at Altitudes ≤ 2000m
Note: All specifications are based on constant conditions	

1.2. COMPLIANCE AND CERTIFICATIONS

This product is CE compliant and adheres to the Low Voltage and ElectroMagnetic Compatibility directives.

For any other certifications, please refer to this product's specifications sheet on our website.

2. GETTING STARTED

This section addresses unpacking, connecting, and initializing the instrument, getting an overview of the menu system, and setting up/configuring the functions.

2.1. UNPACKING



CAUTION - GENERAL SAFETY HAZARD

To avoid personal injury, always use two persons and proper lift and carry techniques to move/relocate the analyzer.

ATTENTION

COULD DAMAGE INSTRUMENT AND VOID WARRANTY

Printed Circuit Assemblies (PCAs) are sensitive to electro-static discharges too small to be felt by the human nervous system. Failure to use Electro-Static Discharge (ESD) protection when working with electronic assemblies will void the instrument warranty. Refer to the manual, Fundamentals of ESD, PN 04786, which can be downloaded from our website at <http://www.teledyne-api.com>.

ATTENTION

COULD DAMAGE INSTRUMENT AND VOID WARRANTY

Do not operate this instrument without first removing dust plugs from SAMPLE and EXHAUST ports on the rear panel.

Note

Teledyne API recommends that you store shipping containers and materials for future use if/when the instrument should be returned to the factory for repair and/or calibration service. See Warranty statement in this manual and Return Merchandise Authorization (RMA) on our Website at <http://www.teledyne-api.com>.

Verify that there is no apparent external shipping damage. If damage has occurred, please advise the shipper first, then Teledyne API.

Included with your instrument is a printed record of the final performance characterization performed on your instrument at the factory. This record, titled Final Test and Validation Data Sheet, is an important quality assurance and calibration record and should be placed in the quality records file for this instrument.

With no power to the unit, carefully remove the top cover of the instrument and check for internal shipping damage by carrying out the following steps:

1. Carefully remove the top cover and check for internal shipping damage.
 - a. Remove the screws located on the instrument's sides.
 - b. Slide the cover backward until it clears the instrument's front bezel.
 - c. Lift the cover straight up.
2. Inspect the interior of the instrument to ensure all circuit boards and other components are intact and securely seated.
3. Check the connectors of the various internal wiring harnesses and pneumatic hoses to ensure they are firmly and securely seated.
4. Verify that all of the optional hardware ordered with the unit has been installed. These are listed on the paperwork accompanying the instrument.



WARNING – ELECTRICAL SHOCK HAZARD

Never disconnect or reconnect PCAs, wiring harnesses or electronic subassemblies while instrument is under power.

2.1.1. VENTILATION CLEARANCE

Whether the instrument is set up on a bench or installed in a rack, be sure to leave sufficient ventilation clearance.

Table 2-1. Ventilation Clearance

AREA	MINIMUM REQUIRED CLEARANCE
Back of the instrument	10 cm / 4 in
Sides of the instrument	2.5 cm / 1 in
Above and below the instrument	2.5 cm / 1 in

2.2. INSTRUMENT LAYOUT

Instrument layout includes front panel, rear panel connectors, and the internal chassis layout.

2.2.1. FRONT PANEL

The front panel (Figure 2-1) includes two USB ports for peripheral device connections, which can be used with mouse and keyboard as alternatives to the touchscreen interface, or with flash drive for uploads/downloads (devices not included).

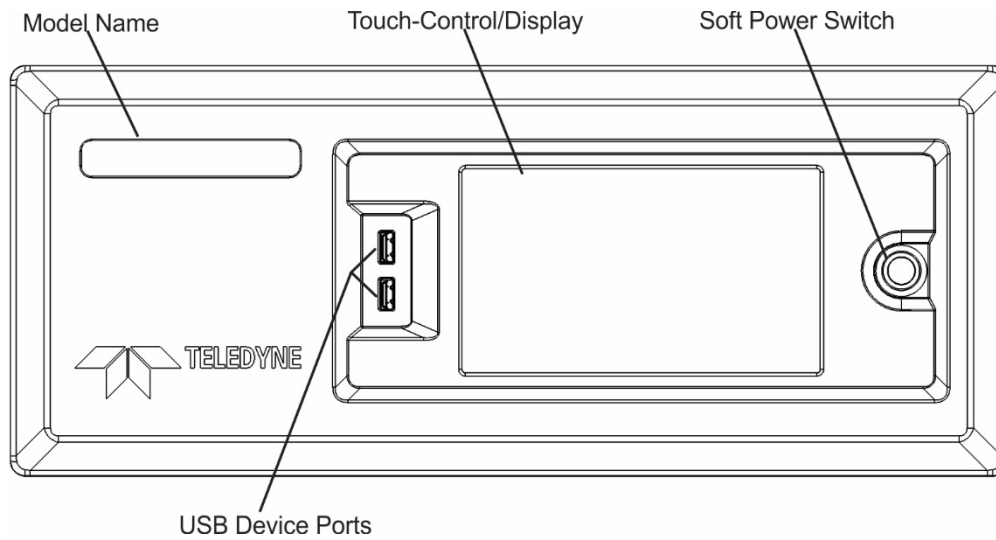

Figure 2-1. Front Panel Layout

2.2.2. REAR PANEL

Figure 2-2 shows the layout of the rear panel, and Table 2-2 provides descriptions.

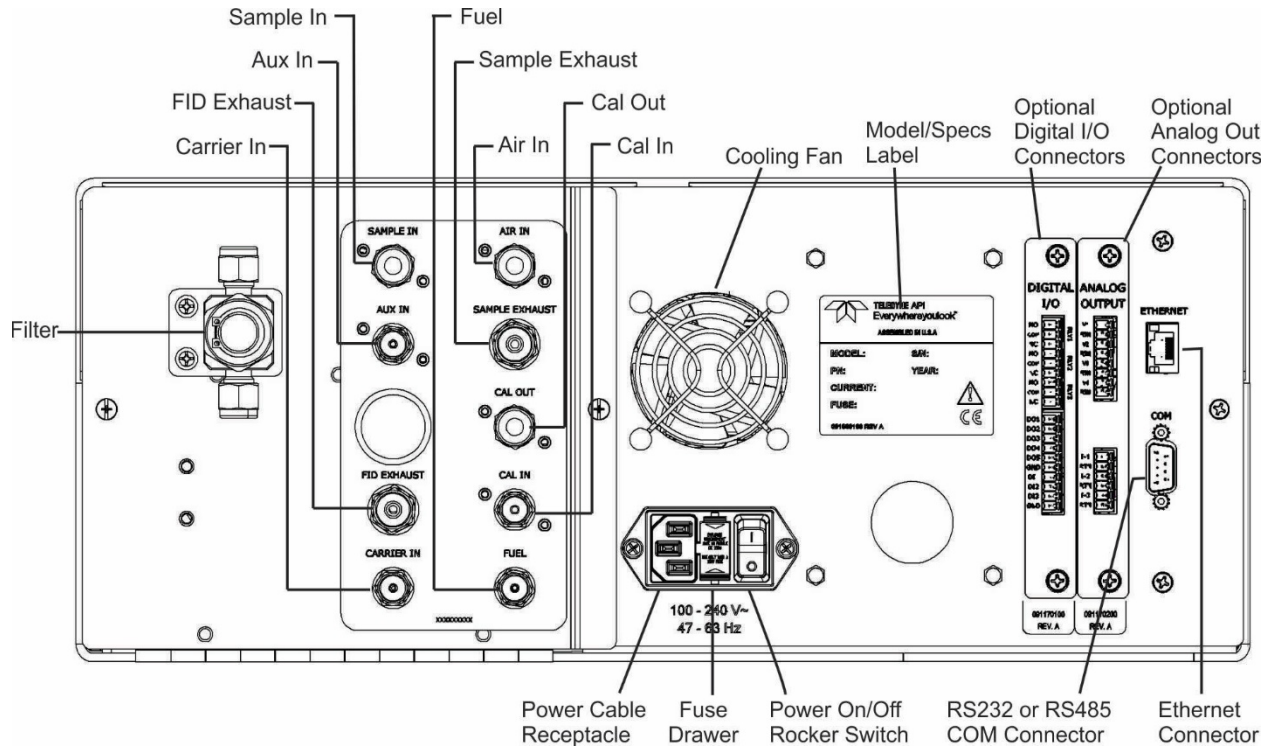



Figure 2-2. Rear Panel Layout

Table 2-2. Rear Panel Description

COMPONENT	FUNCTION
AIR IN	Connect an air source free of hydrocarbon and moisture. The pressure must be between 45-55 PSI. The air consumption is 350CCM
AUX IN*	Connect clean zero air or Nitrogen with pressure between 65-75 PSI to actuate the switch valve. It is possible to connect both CARRIER IN and AUX-IN ports on one line. The consumption of the Aux In is 1CC per actuation
FID EXHAUST	Keep this port clear and open in a well-ventilated area for output from the FID, which is primarily air and some water vapor and other combustion byproducts. If instrument is in an enclosed or poorly ventilated area, vent this port with shortest line possible with the largest inner diameter possible in order to prevent back pressure to the detector.
CARRIER IN*	Connect UHP Nitrogen (N ₂) gas (99.999% purity). The pressure supplied must be between 45-70 PSI. The gas consumption is ~20 CCM.
SAMPLE IN	Connect a gas line from the source of sample gas to the externally mounted filter. Calibration gas can also enter here, at ambient pressure, on units without the pressurized valve option installed.
SAMPLE EXHAUST	Connect an exhaust gas line of not more than 10 meters long here that leads outside the shelter or immediate area surrounding the instrument. The line must be ¼" tubing or greater.
Cal Out	For use in calibration when valve options installed. Connect the output to the Sample In port with Tee fitting to vent the extra gas
Cal In	For use in calibration when valve options installed. The Calibration gas that connects to the ports should be 15PSI ± 2PSI
FUEL	Connect UHP Hydrogen (H ₂) gas (99.999% purity) with pressure between 45-55 PSI. Fuel consumption is ~35 SCCM while flame is on. (Fuel line is shut off during Standby mode to minimize fuel consumption).
Cooling fan	Pulls ambient air into chassis through side vents and exhausts through rear.
	Power cable connector Connector for three-prong cord to apply AC power to the analyzer. CAUTION! The cord's power specifications (specs) MUST comply with the power specs on the analyzer's rear panel label
	Power On/Off Switch Rocker switch to power unit on or off. CAUTION! Prior to powering OFF, use front panel button for "soft" power-down of internal components.
Fuse drawer	For circuit protection.
Model/specs label	Identifies the analyzer model number and provides power specs.
DIGITAL I/O Option	For remotely activating the span calibration mode.
ANALOG OUT Option	For voltage or current loop outputs to a strip chart recorder and/or a data logger.
ETHERNET	Connector for network or Internet remote communication, using Ethernet cable.
COM	Serial communications port for RS-232.

* It is possible to connect both CARRIER IN and AUX-IN ports on one line, using a tee-fitting, only if the line can supply 70 PSI continually (between 65-75 PSI).

2.2.3. INTERNAL CHASSIS

Figure 2-3 shows the internal chassis layout.

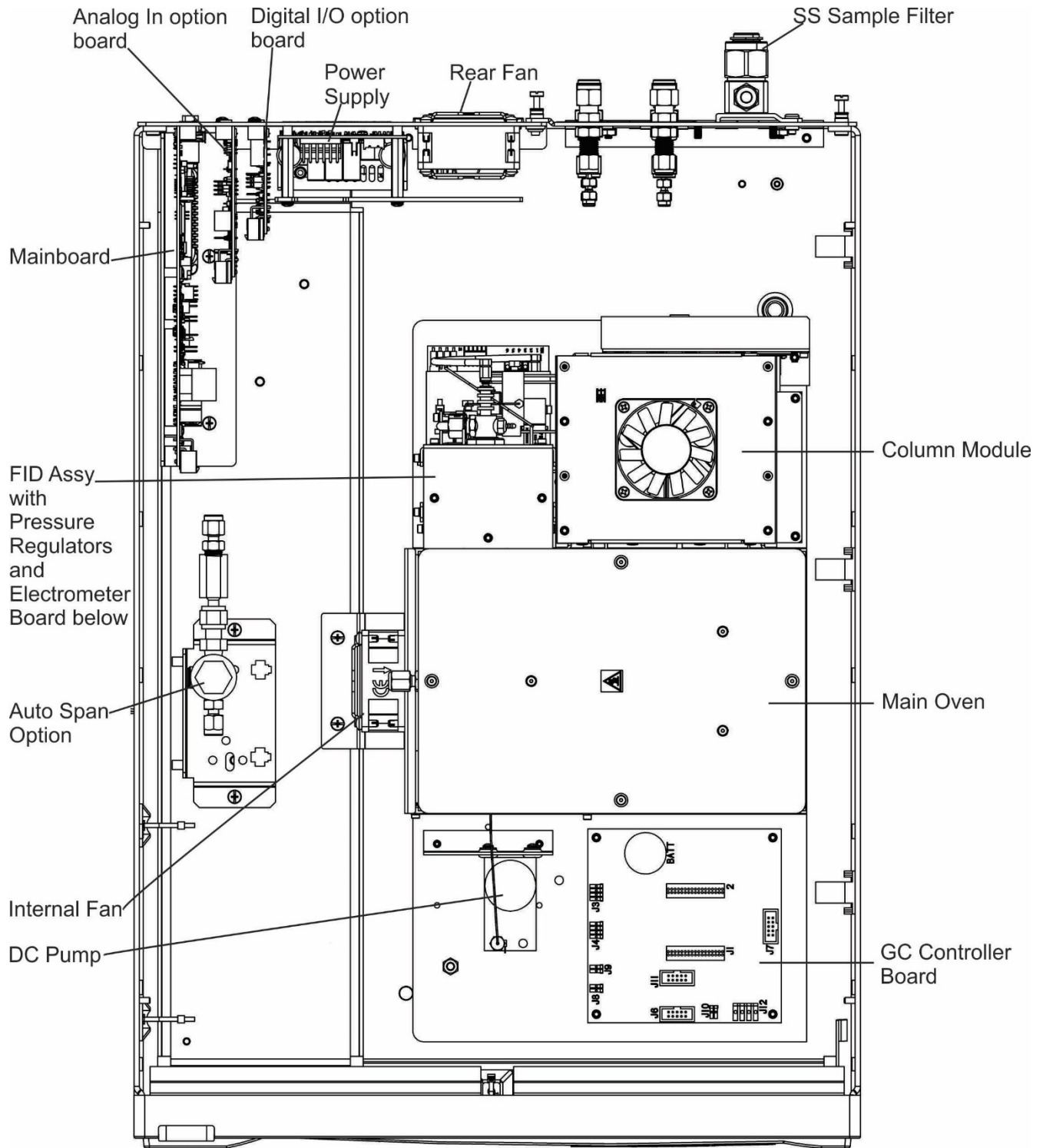

Figure 2-3. Internal Chassis Layout

2.3. CONNECTIONS AND STARTUP

This section presents the electrical (Section 2.3.1) and pneumatic (Section 2.3.2) connections for setting up and preparing the instrument for operation (Section 2.3.3).

2.3.1. ELECTRICAL CONNECTIONS

Note

To maintain compliance with EMC standards, cable length must be no greater than 3 meters for all I/O connections.



WARNING – Electrical Shock Hazard

- High Voltages are present inside the instrument's case.
- Power connection must have functioning ground connection.
- Do not defeat the ground wire on power plug.
- Turn off instrument power before disconnecting or connecting electrical subassemblies.
- Do not operate with cover off.



CAUTION – Avoid Damage to the Instrument

Ensure that the AC power voltage matches the voltage indicated on the instrument's rear panel before plugging it into line power.

2.3.1.1. CONNECTING POWER

ATTENTION

COULD DAMAGE INSTRUMENT AND VOID WARRANTY

Never power off the instrument from the rear panel Hard Power switch before first placing the internal computerized components into deep sleep mode through the front panel Soft Power switch. Press and momentarily hold the front panel Soft Power switch, which triggers the Supervisory chip to safely shut down the internal components. The LED state then changes from solid lit to blinking, at which time the rear panel Hard Power switch can be used to power off the instrument.

Attach the power cord between the instrument's AC power connector and a power outlet capable of carrying at least the rated current at your AC voltage range and ensure that it is equipped with a functioning earth ground. It is important to adhere to all safety and cautionary messages.

2.3.1.2. CONNECTING ANALOG OUTPUTS OPTION

The optional rear panel Analog Output board offers several channels that can be mapped to reflect various operating values in the analyzer, including concentration values, temperatures, pressures, etc. These mappings are not configured by default and must be set by the user.

The four **voltage** outputs (0-5 V or 0-10 V) are isolated from the instrument but share a common ground. The three **current** outputs are individually isolated from each other and from the instrument.

To access these signals, attach a strip chart recorder and/or data-logger to the appropriate analog output connections, and configure through the Setup>Analog Outputs menu.

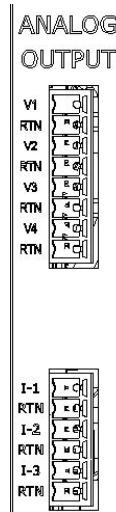

Figure 2-4. Analog Outputs Connectors Panel Option

Table 2-3. Analog Output Pin Assignments

PIN	OUTPUT	DESCRIPTION
Isolated Voltage Outputs		
V1	V +	User definable through the Setup>Analog Outputs menu.
RTN	Ground	
V2	V +	
RTN	Ground	
V3	V +	
RTN	Ground	
V4	V +	
RTN	Ground	
Isolated Current Outputs		
I-1	I Out +	User definable through the Setup>Analog Outputs menu.
RTN	I Out -	
I-2	I Out +	
RTN	I Out -	
I-3	I Out +	
RTN	I Out -	

2.3.1.3. CONNECTING THE DIGITAL I/O EXPANSION BOARD OPTION

The connections on this board include three relay alarms, five digital outputs, and three isolated digital input controls. The **Relays** can be mapped to reflect various internal instrument conditions and states. The **Outputs** are isolated from the instrument and consist of open collector transistors with a common ground; they can be mapped to reflect various internal instrument conditions and states; they can be used to interface with devices that accept logic-level digital inputs, such as Programmable Logic Controllers (PLCs). The **Inputs** are also isolated but share the same ground as the Outputs; they will work with relays, open collectors, or 3.3 V – 24 V logic. Pull low to activate. DI1 and DI2 are fixed (not mappable) for remote zero and span calibrations.

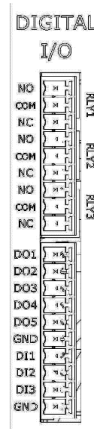

Figure 2-5. Digital I/O Connector Panel Option

Table 2-4. Digital Input/Output Pin Assignments

PIN	DESCRIPTION	
Relays		
NO	RLY 1	Relay Alarms, user-configurable through the Setup>Digital Outputs menu.
COM		
NC		
NO	RLY 2	
COM		
NC		
NO	RLY 3	
COM		
NC		
Digital Outputs and Inputs		
DO1	Digital Outputs mappable in the Setup>Digital Outputs menu, and viewable in the Utilities>Diagnostics>Digital Outputs menu	
DO2		
DO3		
DO4		
DO5		
GND	Ground	
DI1	Digital Input1 = Remote Zero Cal	
DI2	Digital Input2 = Remote Span Cal	
DI3	(Digital Input3 not used)	
DI3	View status in Utilities>Diagnostics>Digital Inputs menu	
GND	Ground	

2.3.1.4. CONNECTING COMMUNICATIONS INTERFACES

ETHERNET CONNECTION

For network or Internet communication with the analyzer, connect an Ethernet cable from the analyzer's rear panel Ethernet interface connector to an Ethernet port. Although the analyzer is shipped with DHCP enabled by default, it should be manually configured with a static IP address.

SERIAL CONNECTION

Received from the factory, the analyzer COM port is set up for RS-232 communications with data communication equipment (DCE). This port can be reconfigured for RS-232 communications with data terminal equipment (DTE) by jumpering the pins on JP1 as indicated in Table 2-5 (view/edit software settings Table 2-11).



WARNING – ELECTRICAL SHOCK HAZARD

Disconnect all power before performing any operation that requires entry into the interior of the analyzer.

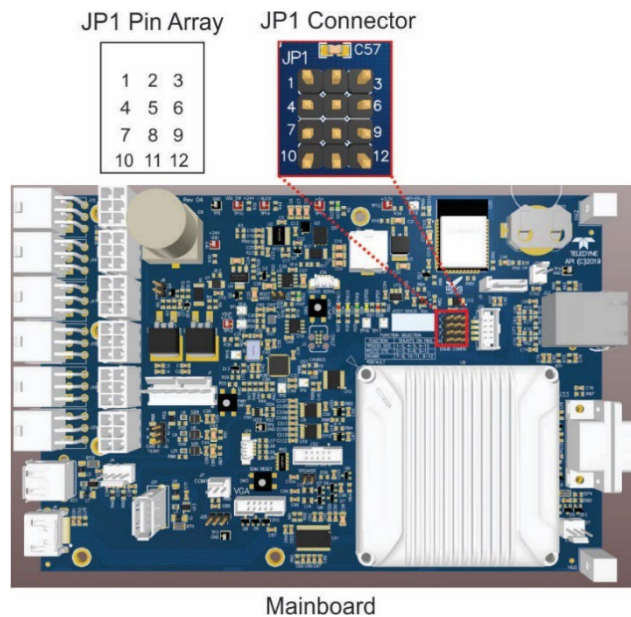

Figure 2-6. Mainboard JP1 Location and Pin Arrangements

Table 2-5. JP1 Configurations for Serial Communication

Function	Jumpers	DSub Pins	
		2	3
DCE RS232 (default)	1-2, 4-5, 9-12	232Tx	232Rx
DTE RS232	2-3, 5-6, 9-12	232Rx	232Tx

View/edit the Communications parameters in the Setup>Comm>COM1 menu.

RS-232

- **Baud rate:** 115200 bits per second (baud)
- **Data Bits:** 8 data bits with 1 stop bit
- **Parity:** None

2.3.2. PNEUMATIC CONNECTIONS

This section provides pneumatic connection and setup instructions for basic configuration. Pneumatic flow diagrams are shown in Section 2.3.3. Calibration instructions are provided in Section 4.

Before making the pneumatic connections, carefully note the following cautionary and special messages:

Important

IMPACT ON READINGS OR DATA



- **AUX IN** requires **MINIMUM 65 psi**.
- **Never operate** without filter assembly installed and intact.
- **Sample and calibration gases** should only come into contact with PTFE, Stainless-Steel, or other inert tubing.
- **Do NOT** place any mufflers or filters downstream of the pump, i.e., external to the instrument.
- **Run a leak check** once the appropriate pneumatic connections have been made; check all pneumatic fittings for leaks per Section 5.4.12.1 (or Section 5.4.12.2 for detailed check if any leaking is suspected).



CAUTION – General Safety Hazard

Do not vent calibration gas or sample exhaust gas into enclosed areas.



CAUTION – General Safety Hazard

Consult with Technical Support on additional safety issues.

ATTENTION

COULD DAMAGE INSTRUMENT AND VOID WARRANTY

VENT PRESSURIZED GAS:

When any gas (span, zero air, sample) is received from a pressurized manifold, always provide a vent to equalize the pressure with the ambient atmosphere before it enters the instrument to ensure that the gases input do not exceed the instrument's maximum inlet pressure, as well as to prevent back diffusion and pressure effects.

PREVENT BACKPRESSURE IN FID EXHAUST

If tubing is required, ensure it is the shortest line possible and the largest inner diameter possible.

REMOVE DUST PLUGS:

Remove dust plugs from rear panel Sample and FID exhaust ports and supply line fittings before powering on the instrument.

Keep dust plugs for reuse in future storage or shipping to prevent debris from entering the pneumatics.

2.3.2.1. CRITICAL TUBING, PRESSURE, VENTING AND EXHAUST REQUIREMENTS

The requirements presented in this section apply to all pneumatic connection instructions.

Tubing:

- Outer diameter (OD) minimums and material:
 - 1/4" OD for Air Gas, Sample, and Sample Exhaust, PTFE or Stainless Steel
 - 1/8" OD for H₂, Carrier, and Auxiliary gases, Stainless Steel only
- Min/max length 2 meters to 10 meters
- Refer to Table 2-2 for FID EXHAUST requirements.

Pressure:

- All Sample gas pressure must be at ambient atmospheric pressure, no greater or less than 1.0 psig.

Venting (to prevent back diffusion and pressure effects):

- Run tubing outside the enclosure or at least away from immediate area surrounding the instrument.
- Refer to Table 2-2 for FID EXHAUST requirements.

Sample Exhaust Outlet:

- Run tubing outside the enclosure.

FID Exhaust Outlet:

- Refer to Table 2-2

Calibration Gas Sources:

- The source of calibration gas or zero air is also attached to the **SAMPLE** inlet, but only when a calibration operation is actually being performed.

2.3.2.2. BASIC PNEUMATIC CONNECTIONS

Please refer to Table 2-2 for additional notes regarding these connections.

Ensure to prevent backflow.

AIR IN	Connect an air source free of hydrocarbon and moisture, pressurized at 50 PSI.
AUX IN*	Connect clean zero air or Nitrogen at 70 PSI to actuate the switch valve. The consumption of the Aux In is 1cc per actuation *It is possible to connect both CARRIER IN and AUX-IN ports on one line with 70 psi nitrogen gas. The consumption of the Aux In is 1cc per actuation.
FID EXHAUST	Keep this port clear and open in a well-ventilated area. If instrument is in an enclosed or poorly ventilated area, vent this port with shortest line possible with the largest inner diameter possible in order to prevent back pressure to the detector.
CARRIER IN	Connect UHP Nitrogen (N ₂) gas (99.999%), pressurized at 50 PSI.
SAMPLE IN	Connect a gas line from the source of sample gas here.
SAMPLE EXHAUST	Connect an exhaust gas line of ¼" tubing not more than 10 meters long here that leads outside the shelter or immediate area surrounding the instrument.
FUEL	Connect UHP Hydrogen (H ₂) gas (99.999% pure) pressurized at 50 PSI.

2.3.2.3. BASIC CONNECTIONS FROM CALIBRATOR

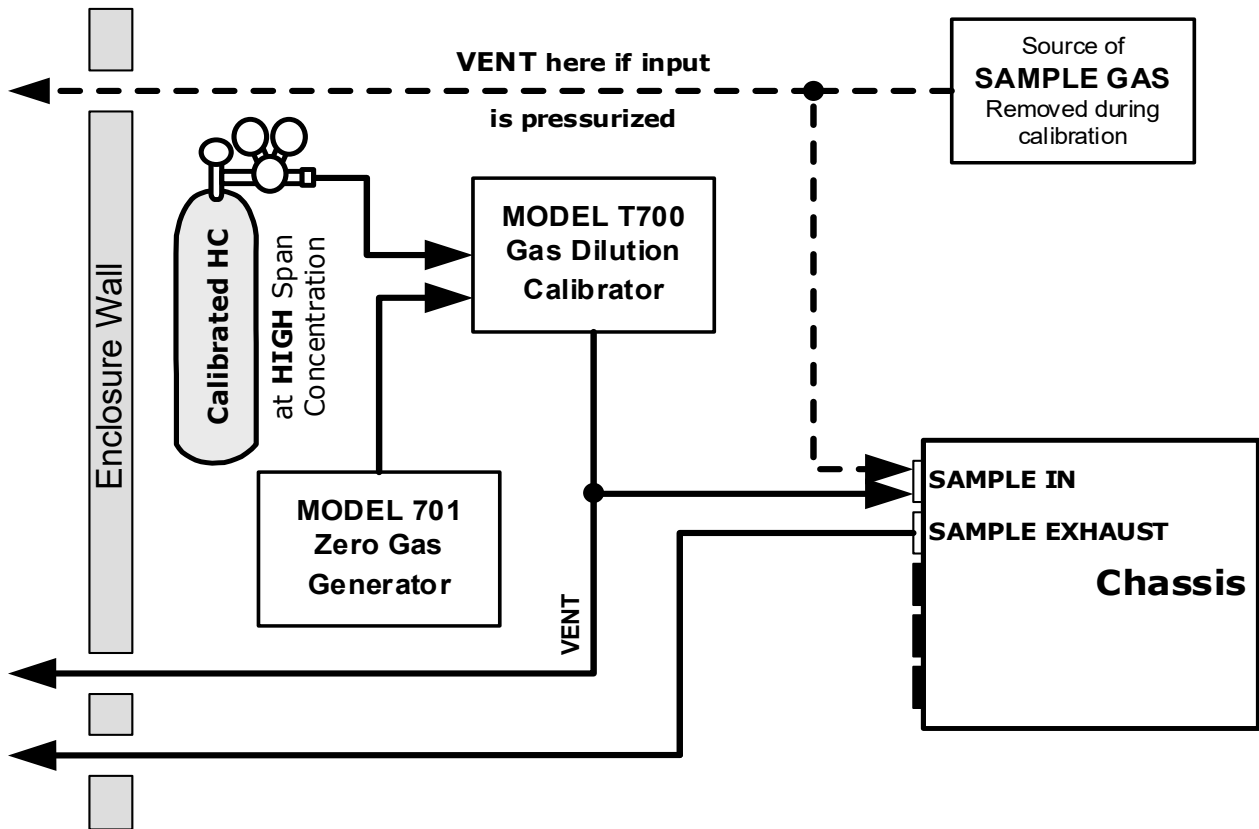

Figure 2-7. Gas Line Connections from Calibrator – Basic Configuration

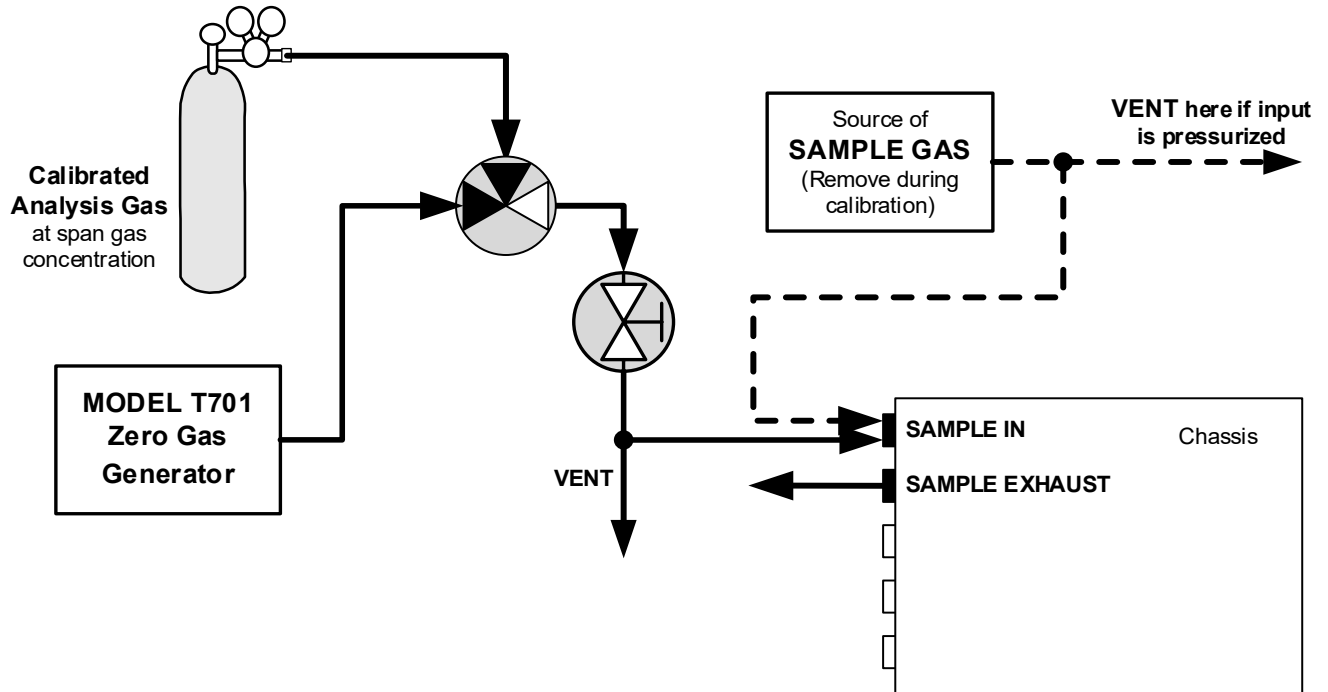

Figure 2-8. Gas Line Connections without Calibrator

For the analyzer's basic configuration, in addition to tubing, pressure, venting, and exhaust requirements set out in Section 2.3.2.1, attach the following pneumatic lines:

SAMPLE GAS SOURCE

Connect a sample gas line to the filter at the SAMPLE IN port.

CALIBRATION GAS SOURCES

SPAN CAL GAS & ZERO AIR SOURCES: The source of calibration gas and zero gas are routed through the T700 and attached to the SAMPLE IN port.

VENTING

Vent the output of the calibrator if calibrator not already vented.

EXHAUST OUTLET

Attach an exhaust line to the SAMPLE EXHAUST outlet fitting and vent outside the shelter.

2.3.3. PNEUMATIC FLOW DIAGRAMS

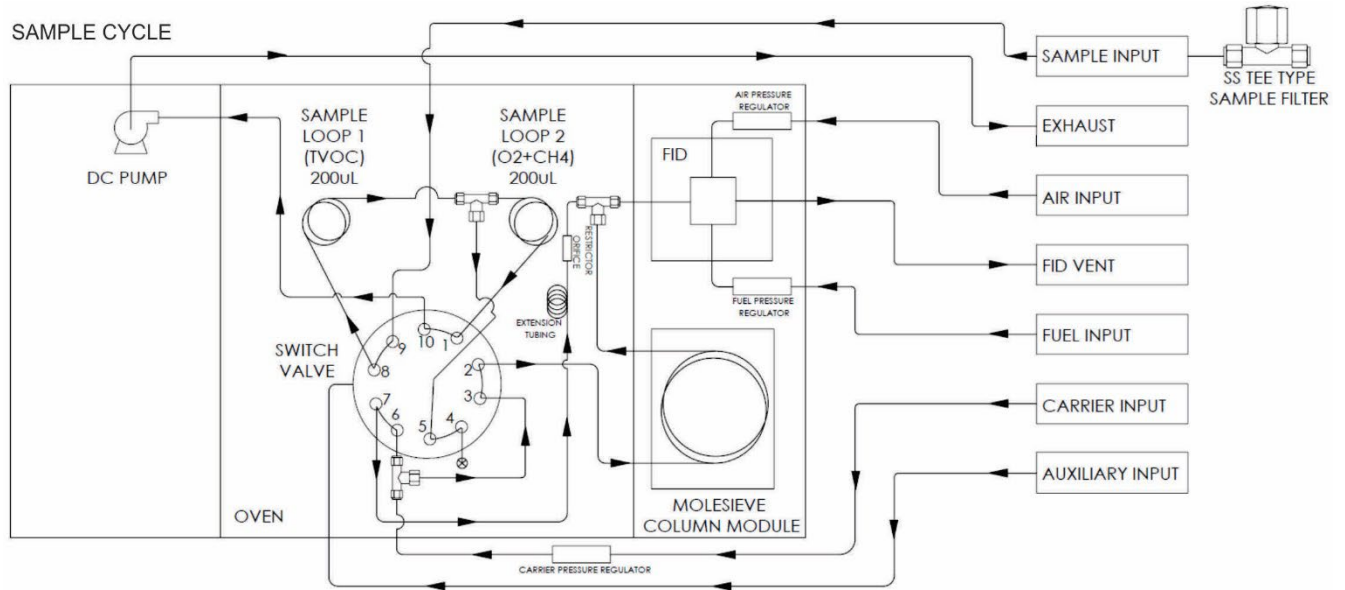

Figure 2-9. Pneumatic Flow Diagram of Sample Capture Cycle

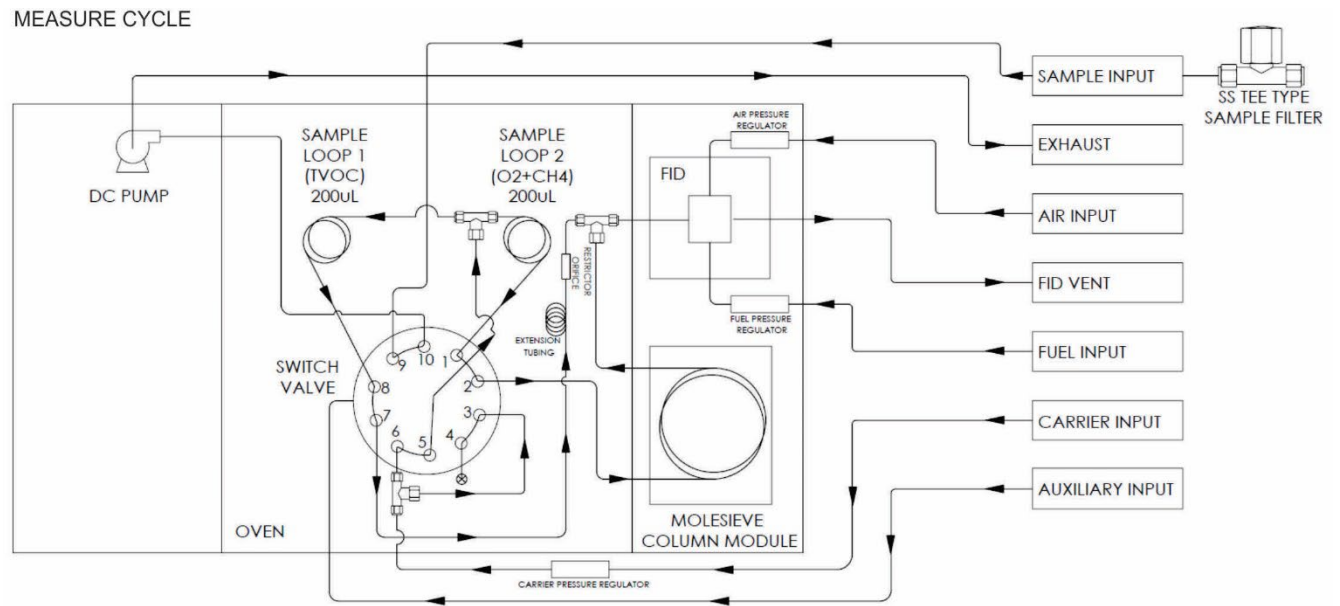

Figure 2-10. Pneumatic Flow Diagram of Measure Cycle

SAMPLE CYCLE

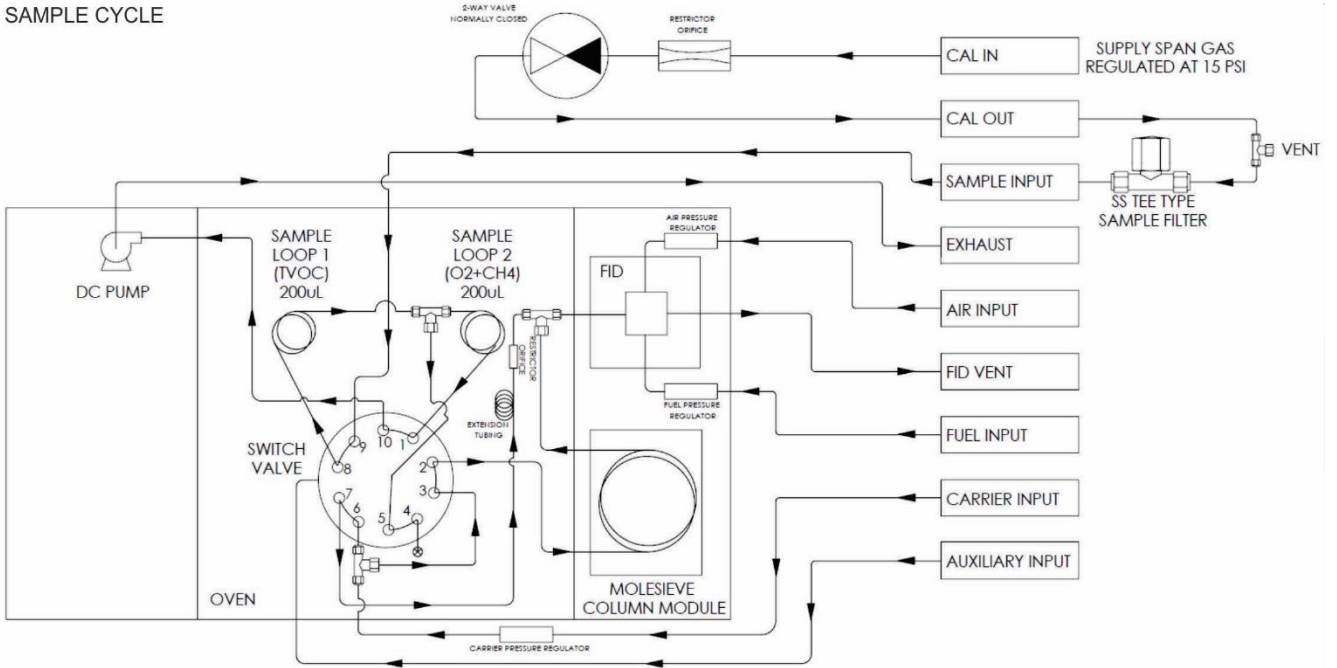

Figure 2-11. Pneumatic Flow Diagram of Sample Capture Cycle with Span Valve Option

MEASURE CYCLE

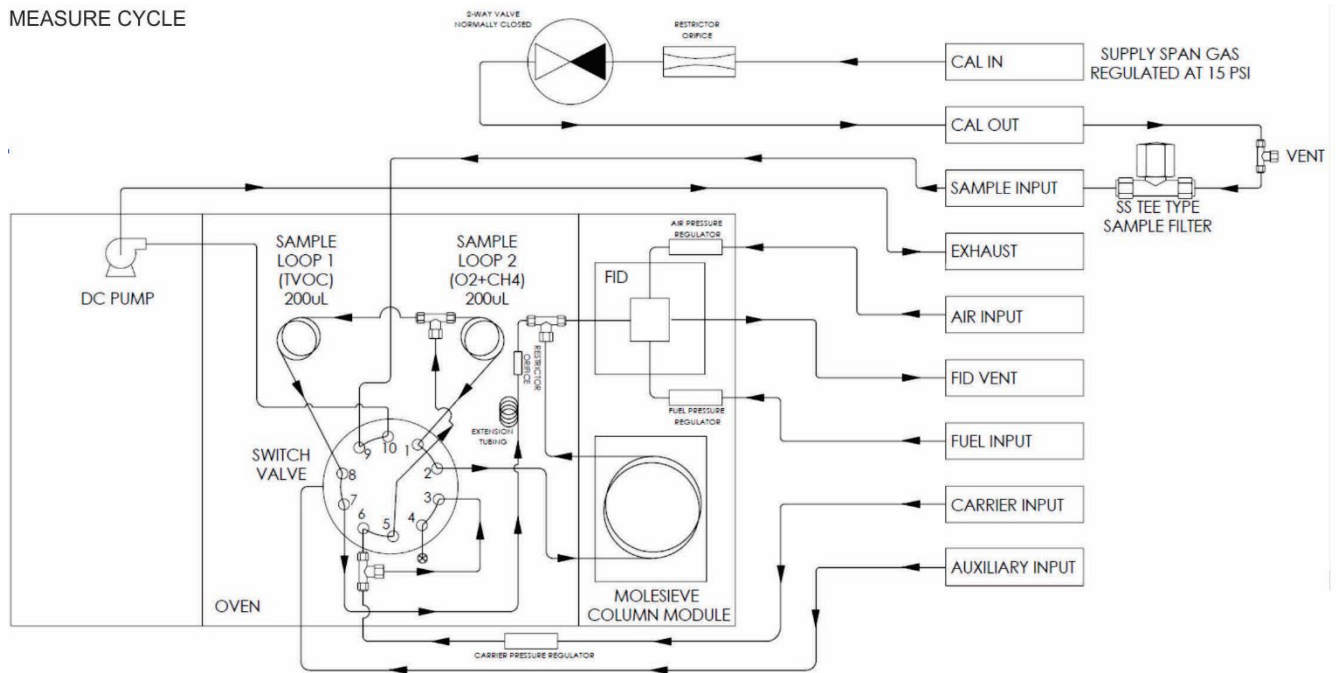

Figure 2-12. Pneumatic Flow Diagram of Measure Cycle with Span Valve Option

2.3.4. STARTUP, FUNCTIONAL CHECKS AND CALIBRATION

We recommend reading Section 6 to become familiar with the principles of operation.

Note

It is expected that all cautionary messages are being followed.

2.3.4.1. POWER STATUS

The front panel Soft Power switch has a status LED that indicates whether:

- instrument is powered OFF (LED off)
- instrument powered on but internal components in deep sleep mode (LED blinking, achieved by pressing and momentarily holding the button)
- instrument powered on and internal components are operating (LED solid lit; never use the rear panel Hard Power switch when the front panel LED is solid lit).

When the instrument is first started (Section 2.3.4.2), check its functionality (Section 2.3.4.4). The analyzer is calibrated at the factory and no additional calibration should be required before operation begins. (However, if calibration is required, instructions are presented in Section 4).

Section 2.4 introduces the menu system, and Section 2.5 provides setup/customization instructions.

2.3.4.2. STARTUP

Upon initial startup, a sequence of status screens (Figure 2-13) appear prior to the Home page (Figure 2-14).

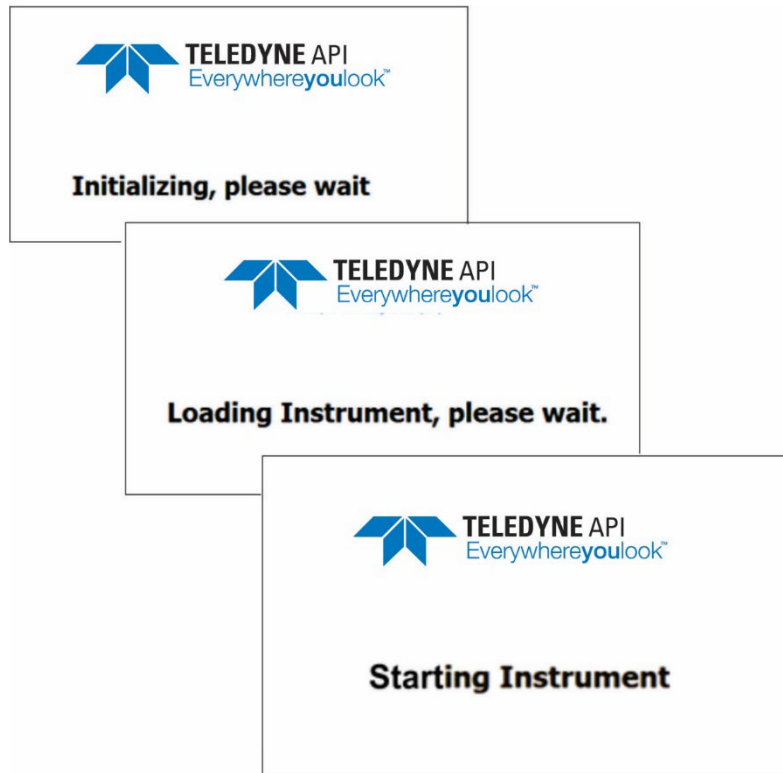

Figure 2-13. Status Screens at Startup

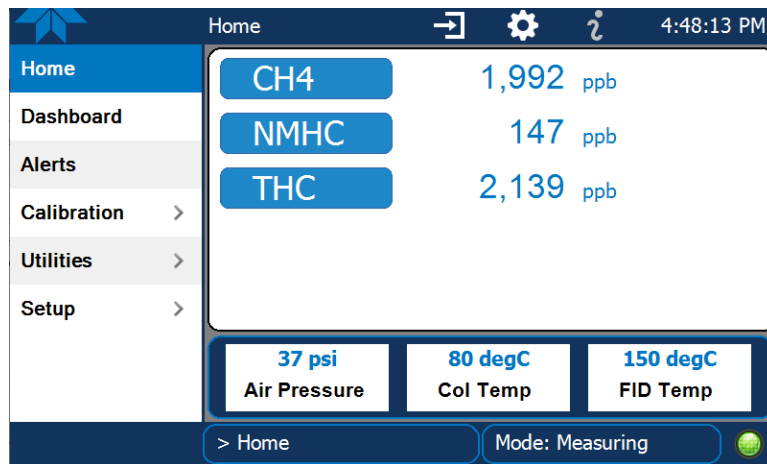

Figure 2-14. Home Page

Upon any startup, this instrument should warm up for approximately one hour before reliable measurements can be taken. The Mode field at the bottom of the interface indicates the various stages of warm-up from pre-ignition to sampling.

Note

If or when needed, sampling can be paused and resumed through the Enter Standby Control and Exit Standby Control features in either of two ways:

- Configure the Homescreen (Section 2.5.7) to include those controls in the meters at the bottom of the page (Figure 2-14) and slide the desired control switch to ON.
- Navigate to Setup>Vars>Enter Standby Control [or Exit Standby Control] and click the Edit button to change the setting to True.

2.3.4.3. ALERTS: WARNINGS AND OTHER MESSAGES

Because internal temperatures and other conditions may be outside the specified limits during the warm-up period, the software will suppress most Alerts for ~45 minutes after power up. The Alerts page (Figure 2-15) shows the status of any active warning conditions or user-configured Events. (Section 2.4.3 provides more detailed information about Alerts, and Section 2.5.2 addresses Events).

Alerts can be viewed and cleared via either the Alerts menu or the Alerts shortcut (Caution symbol, bottom right corner of the screen). Although these alerts can be cleared from the Active Alerts page, a history of all alerts remains in the Utilities>Alerts Log page.

Navigate to the Active Alert page via the Alerts menu on Home screen.

(Also view a list of all active and past Alerts and Events via Utilities>Alerts Log).

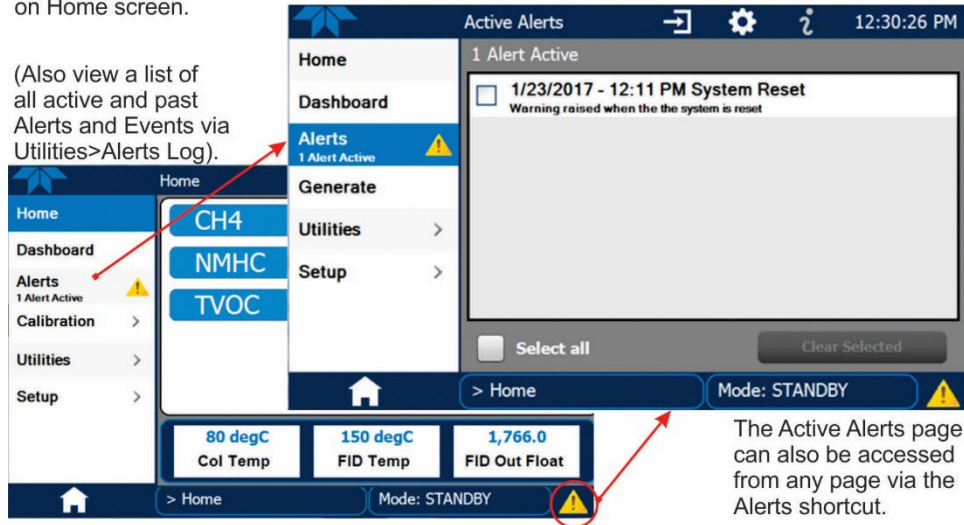

Figure 2-15. Viewing Active Alerts Page

If Alerts about warning conditions persist after the warm-up period or after being cleared, investigate their cause using the troubleshooting guidelines in Section 5.5.1.

2.3.4.4. FUNCTIONAL CHECKS

After warm-up, verify that the software properly supports any hardware options that are installed (Setup>Instrument menu), and that the instrument is functioning within allowable operating parameters. View the Dashboard page to check that parameters show expected/reasonable values. (If any functional parameters are not displayed, configure the Dashboard through the Setup>Dashboard menu to add them; see Section 2.5.3). If Flame Status shows “Out,” or GC Status shows “Not Ready,” refer to Section 5.5.5.

Alerts serve as notifications if anything is not functioning properly.

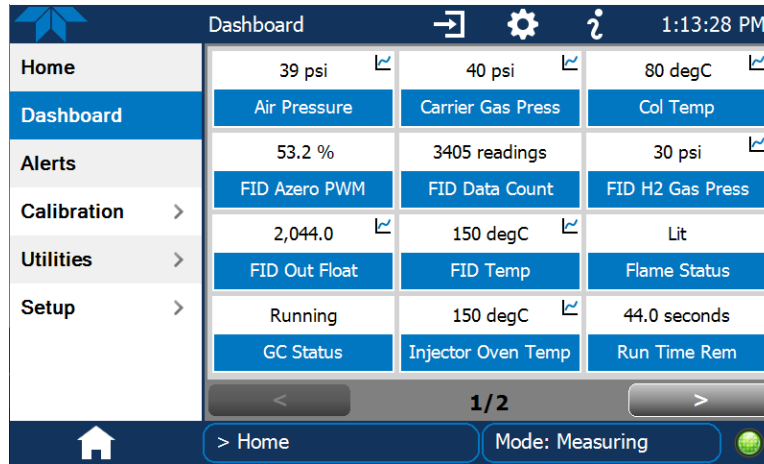

Figure 2-16. Sample Dashboard Page

2.4. MENU OVERVIEW

Table 2-6 describes the main menus and provides cross-references to the respective sections with configuration details.

Table 2-6. Menu Overview

MENU	DESCRIPTION	LOCATION
Home	View and plot concentration readings and other selectable parameter values (Figure 2-18).	Section 2.4.1
Dashboard	View user-selected parameters and their values, some of which can be displayed in a live-plot graph (Figure 2-19. Parameter Graph from Dashboard Page).	Section 2.4.2
Alerts	View and clear active Alerts that were triggered by factory-defined Events as well as user-defined Events. (Active and past Alerts are recorded in the Utilities>Alerts Log).	Section 2.4.3
Calibration	Run calibrations or calibration checks on the target analysis gas channel or channels if more than one gas.	Sections 2.4.4 and 4
Utilities	View logs, download data and firmware updates, copy configurations between instruments, and run diagnostics.	Section 2.4.5
Setup	Configure a variety of features and functions through these submenus for customized operation.	Section 2.5
Datalogging	Track and record concentration and calibration data and selectable diagnostic parameters, the reports for which can be viewed in the Utilities>Datalog View menu (Section 2.4.5) and downloaded to a flash drive via the Utilities>USB Utilities menu (Section 2.4.5). Also, select configured Events (Section 2.5.2) and create customized triggers for data logging functions.	Section 2.5.1
Events	Select parameters and define the conditions by which they are to be flagged and recorded in the Alerts log (Section 2.4.3) when they are triggered. Once configured, Events can be used to trigger Datalogs. (Section 2.5.1). Note that some Events are predefined and are not editable.	Section 2.5.2
Dashboard	Monitor instrument functionality (Figure 2-16) via selectable parameters.	Section 2.5.3
Vars	Manually adjust several software variables that define specific operational parameters.	Section 2.5.5
GC Gas Config	Adjust the integration engine for the peaks on the CH4 and THC channels.	Section 2.5.6
Homescreen	Select up to three parameters to be displayed in the meters (Figure 2-17).	Section 2.5.6
Digital Outputs	Map the rear-panel digital outputs to a variety of signals present in the instrument to monitor the status of operating conditions or custom Events.	(with option)
Analog Outputs	Send user-selected parameter readings in the form of user-defined voltage or current loop signals as outputs to a strip chart recorder and/or the data logger.	(with option)
Instrument	View product and system information, including list of options, if any; view network settings; view/adjust Date and Time settings*; and check for firmware updates when connected to a network that is connected to the Internet. *Time Zone change requires special procedures (Section 5.4).	Section 2.5.8
Comm	View and configure network and serial communications.	Section 2.5.10

2.4.1. HOME PAGE

Figure 2-17 presents an orientation to the main display screen; Figure 2-18 shows that pressing the gas name or its concentration value or a meter below displays a live plot of their respective readings. Section 2.5.6 provides configuration instructions.

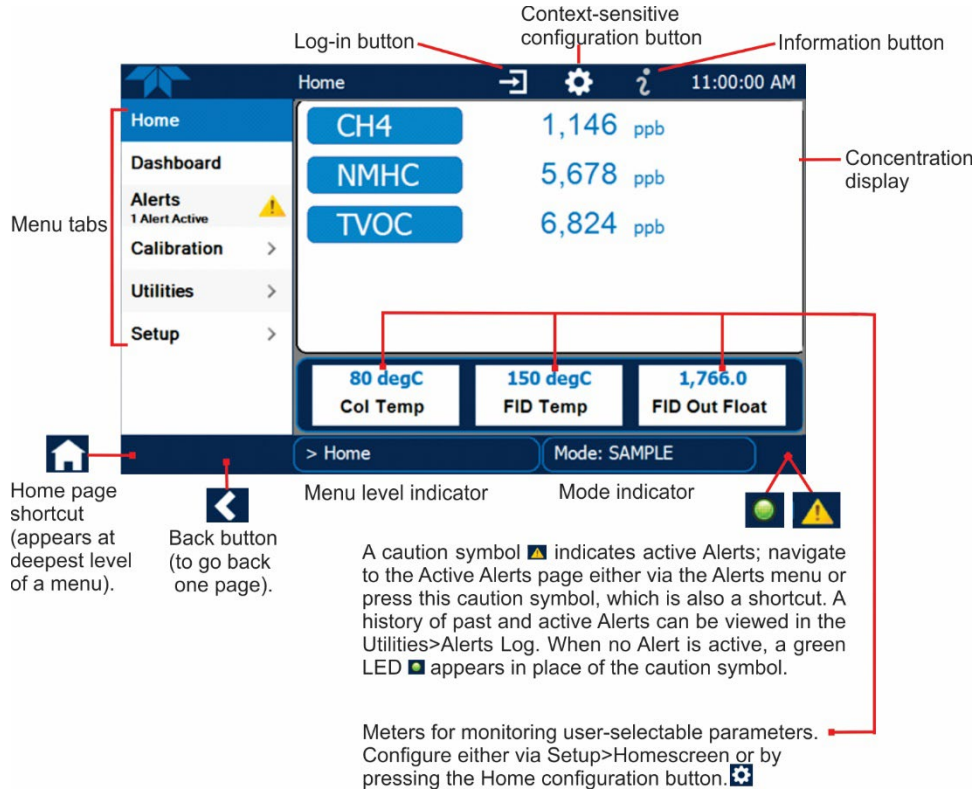
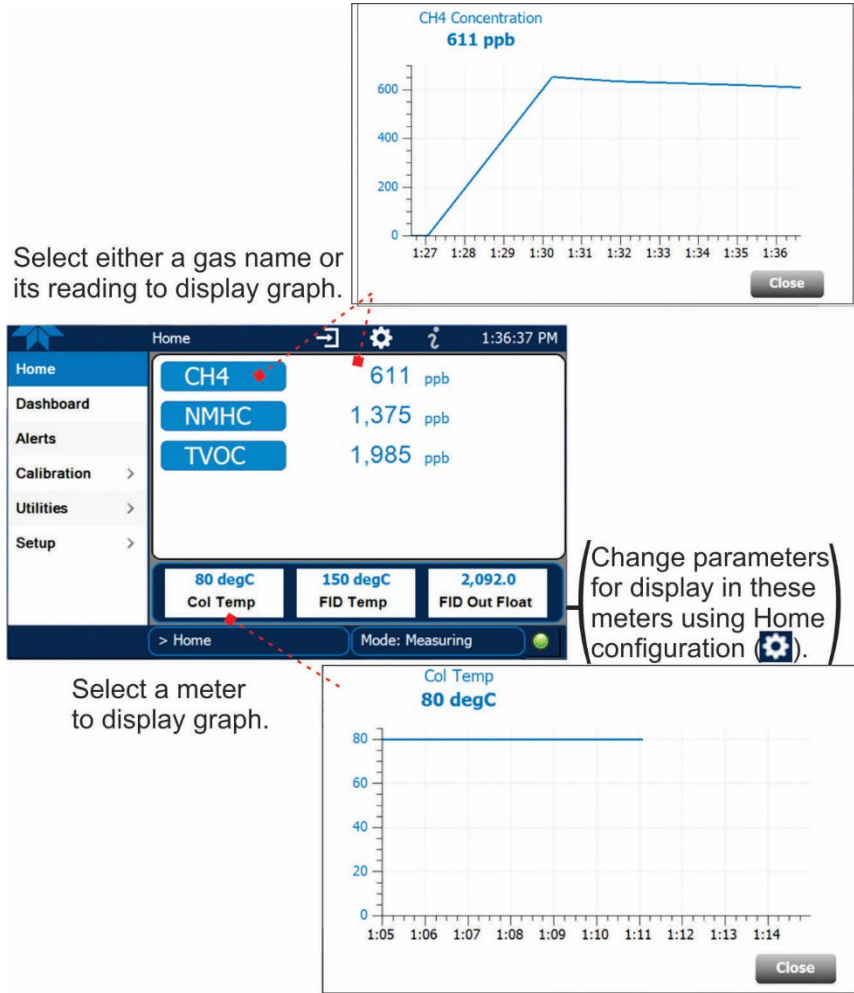

Figure 2-17. User Interface Orientation



Select either a gas name or its reading to display graph.

(Change parameters for display in these meters using Home configuration (gear icon)).

Select a meter to display graph.

Figure 2-18. Concentration Graph (top) and Meter Graph (bottom)

2.4.2. DASHBOARD

The Dashboard displays an array of user-selectable parameters and their values (Section 2.5.3 provides configuration instructions). If there is a graphing icon in the upper right corner of a parameter, pressing that parameter displays a live plot of its readings as in Figure 2-19.



Figure 2-19. Parameter Graph from Dashboard Page

2.4.3. ALERTS

Alerts are notifications triggered by specific criteria having been met by either factory-defined conditions (standard and not editable) or user-defined Events (Section 2.5.2). The Active Alerts page shows the status of any active warning conditions or Events that have been triggered.

When Alerts are triggered, a caution symbol appears in both the Alerts menu tab and in the bottom right corner of the software interface, which serves as a shortcut to the Alerts page from any other page. View a list of currently active Alerts by pressing either the Alerts menu on the Home screen or by pressing the Alerts shortcut (Figure 2-20).

While Alerts can be cleared from the Active Alerts page, they remain recorded in the Utilities>Alerts Log menu.

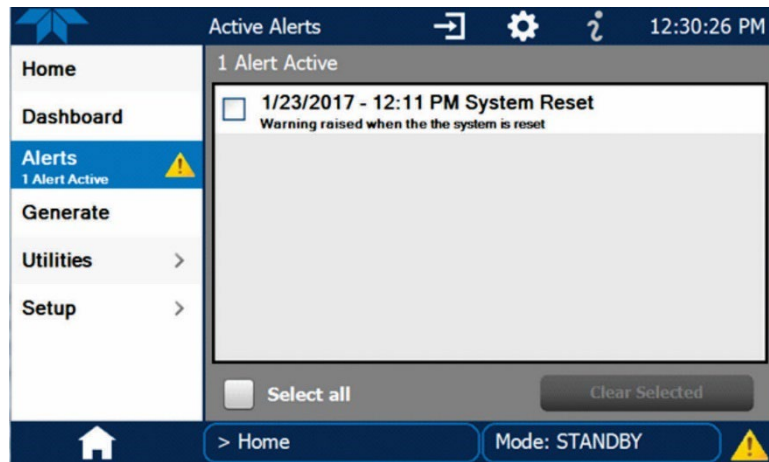

Figure 2-20. Active Alerts Page

Alerts can be configured as either latching (appears in Active Alerts screen when Event is triggered and must be cleared by the user) or non-latching (Active Alerts screen continuously updates based on the Event criteria, clearing on its own). See Section 2.5.2.

To clear Alerts from the Active Alerts page, either check individual boxes to choose specific Alerts, or check the Select All box to choose all Alerts, then press the Clear Selected button.

When all Alerts are cleared, the Alerts menu tab no longer shows the caution symbol, and a green LED replaces the caution symbol in the bottom right corner of the interface (Figure 2-21). However, Alerts can reappear if the conditions causing them are not resolved. For troubleshooting guidance, refer to Section 5.5.

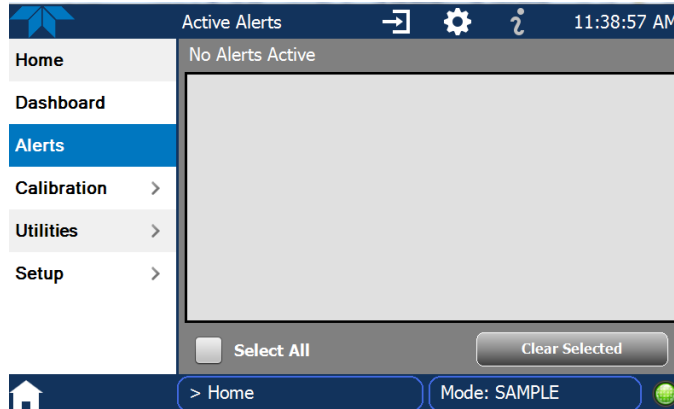

Figure 2-21. Active Alerts Cleared

Alerts and Events remain recorded in the Utilities>Alerts Log (Figure 2-22).

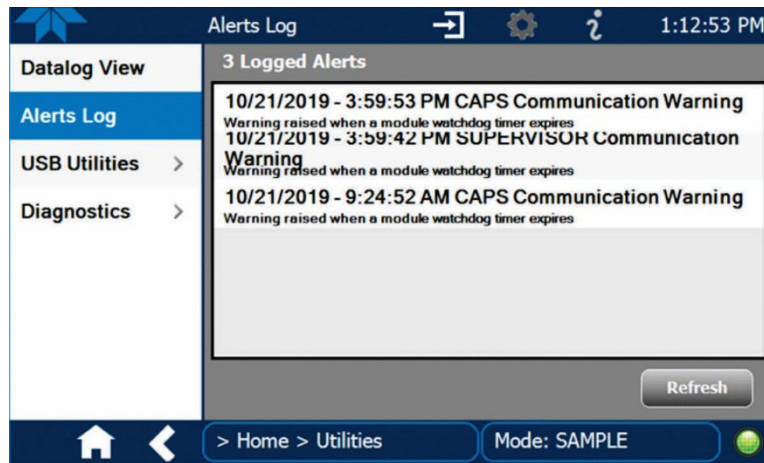

Figure 2-22. Utilities>Alerts Log of Active and Past Alerts and Events

2.4.4. CALIBRATION

The Calibration menu is used for O₂ and span calibrations and for external calibration with valve options installed. Calibration procedures are presented in Section 4.

2.4.5. UTILITIES

The Utilities menu has a variety of functions as described next in Table 2-7.

Table 2-7. Utilities Submenu Descriptions

UTILITIES MENU	DESCRIPTION	
Datalog View	Displays the data logs that were configured via the Setup>Data Logging menu. From this list a log can be selected and filters applied to view the desired data. (For details on setting up and running the Data Logger, see Section 2.5.1).	
Alerts Log	Displays a history of alerts that are triggered by factory-defined and user-defined Events, such as warnings and alarms (See Section 2.5.2 for Events configuration).	
USB Utilities	Serves multiple purposes using a flash drive connected to the instrument's front panel USB port: <ul style="list-style-type: none"> • download data from the instrument's Data Acquisition System (DAS), the Data Logger, to a flash drive (Section 2.5.1.3) • update firmware (Section 5.2) • transfer instrument configuration from/to other same-model instruments (Section 2.6) • download a basic operation functionality report (Section 5.2). 	
Diagnostics	Provides access to various pages that facilitate troubleshooting.	
	Analog Inputs	Shows the raw voltage of preconfigured parameter.
	Analog Outputs (Option)	Shows the Voltage or Current signals for the functions selected and configured in the Setup>Analog Outputs menu. (Section 2.3.1.2 presents the rear panel connections).
	Digital Inputs	Show whether specific available features are turned ON or OFF; input controls are fixed; output controls and relays are configurable in the Setup> Digital Outputs menu. (Section 2.3.1.3 presents the rear panel connections).
	Digital Outputs	Show whether specific available features are turned ON or OFF; input controls are fixed; output controls and relays are configurable in the Setup> Digital Outputs menu. (Section 2.3.1.3 presents the rear panel connections).
	Flow Adjust*	Adjust the flow only when needed if the FID is not easy to light and/or the flame is suboptimal (see Section 5.5.7.1). *Appears when in Standby Mode.

2.4.6. SETUP

The Setup menu is used to configure the instrument's various features, functions, and data log. Section 2.5 provides details for the menus under Setup.

2.5. SETUP MENU: FEATURES/FUNCTIONS CONFIGURATION

Use the Setup menu to configure the instrument's software features, to gather information on the instrument's performance, and to configure and access data from the Datalogger, the instrument's internal data acquisition system (DAS). Once the setups are complete, the saved configurations can be downloaded to a USB drive through the Utilities>USB Utilities menu and uploaded to other instruments of the same model (Section 2.6).

2.5.1. SETUP>DATA LOGGING (DATA ACQUISITION SYSTEM, DAS)

The Datalogger can be configured to capture and store user-defined data, which then can be viewed in the Alerts page, if elected, as well as downloaded from the instrument to a USB flash drive or using NumaView™ Remote software for examination and analysis.

Figure 2-23 shows a new log; Figure 2-24 shows a sample existing log, which can be edited or deleted, and Figure 2-25 provides illustrated instructions for setting up a new log, with Sections 2.5.1.1 and 2.5.1.2 providing additional details.

To transfer captured instrument data to a flash drive, see Section 2.5.1.3.

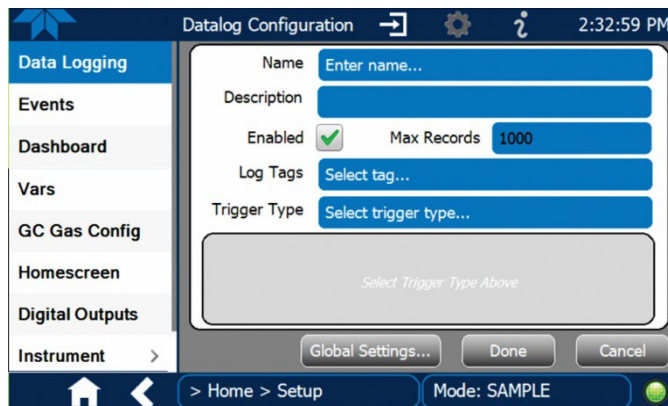

Figure 2-23. Datalog Configuration, New Log Page

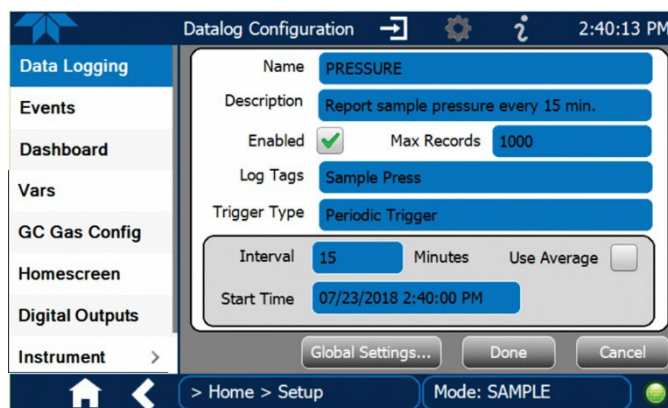

Figure 2-24. Datalog Configuration, Existing Log

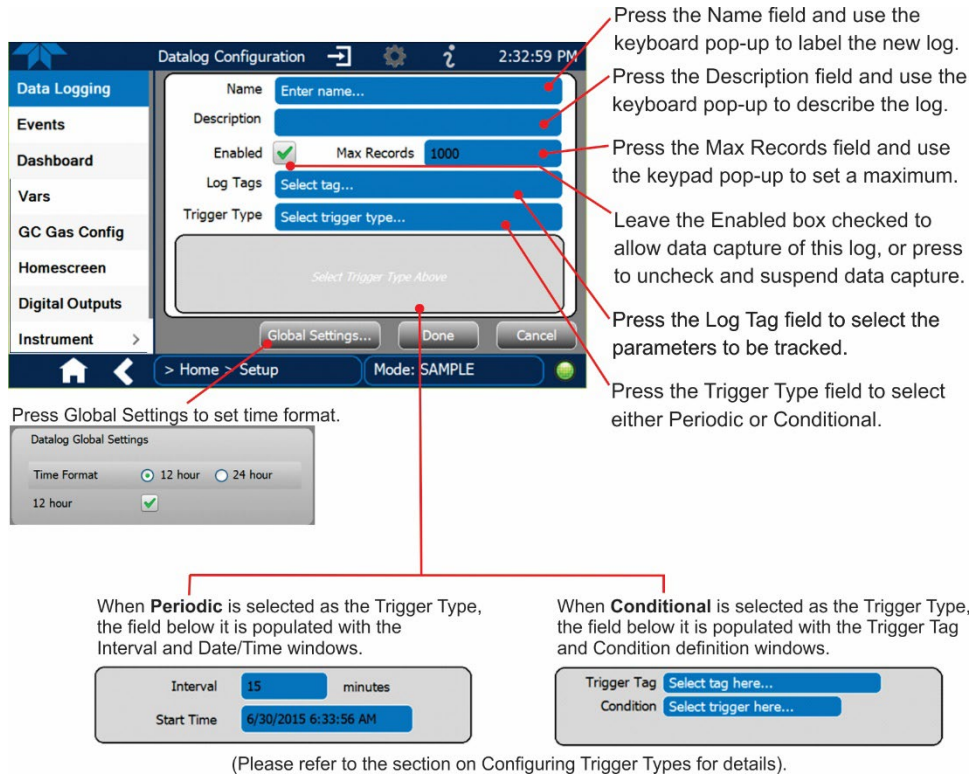
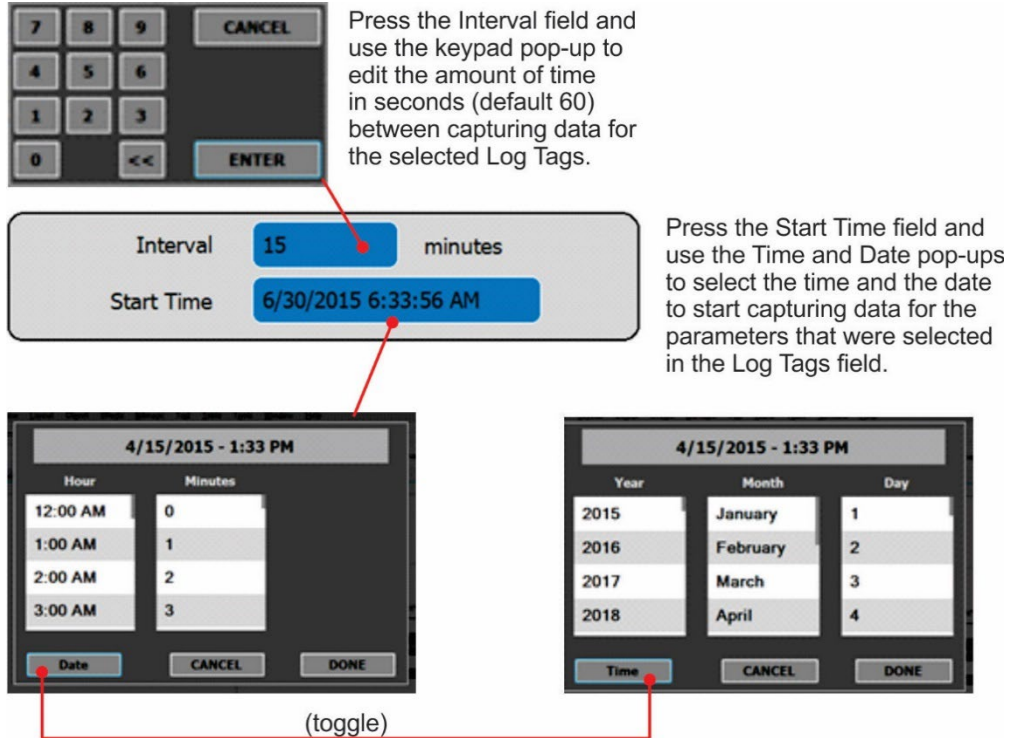

Figure 2-25. Creating a New Data Log

The parameters available in the list of Log Tags include the names of Events configured in the Events page (Section 2.5.2).

2.5.1.1. CONFIGURING TRIGGER TYPES: PERIODIC

The Periodic trigger is a timer-based trigger that is used to log data at a specific time interval. Periodic Trigger requires an interval that is set to number of minutes and a start time that is set to date and clock time.



Press the Interval field and use the keypad pop-up to edit the amount of time in seconds (default 60) between capturing data for the selected Log Tags.

Press the Start Time field and use the Time and Date pop-ups to select the time and the date to start capturing data for the parameters that were selected in the Log Tags field.

(toggle)

Figure 2-26. Datalog Periodic Trigger Configuration

2.5.1.2. CONFIGURING TRIGGER TYPES: CONDITIONAL

Conditional Trigger tracks/records data for user-selected parameters that meet specified conditions.

Press the Trigger Tag field and select a parameter to be tracked/logged. A default Condition associated with the selected Tag will populate the Condition field.

Press the Condition field to select a different choice from the condition list.

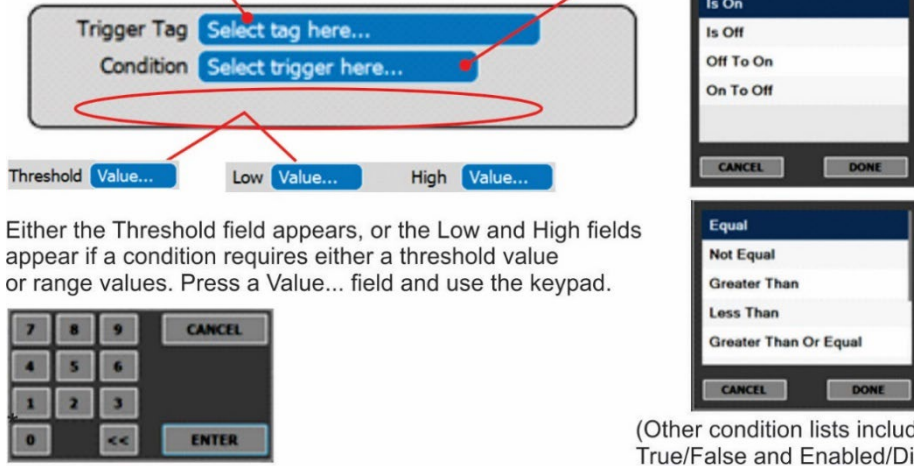

Either the Threshold field appears, or the Low and High fields appear if a condition requires either a threshold value or range values. Press a Value... field and use the keypad.

(Other condition lists include True/False and Enabled/Disabled)

Figure 2-27. Datalog - Conditional Trigger Configuration

2.5.1.3. DOWNLOADING DAS (DATA ACQUISITION SYSTEM) DATA

To download DAS data collected by the Datalogger from the instrument to a flash drive, navigate to the Utilities>USB Utilities>DAS Download menu.

1. Insert a flash drive into a front panel USB port and wait for the Status field to Indicate that the drive has been detected; available buttons will be enabled.

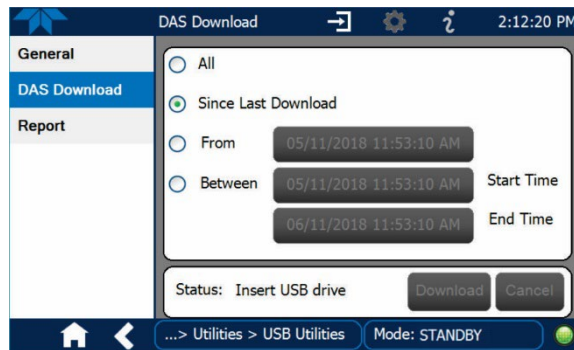

Figure 2-28. DAS Download Page

2. Select all or define a period from which to download the collected data.
3. Press the Download button, and when complete, as indicated in the Status field, press the Done button (changed from "Cancel") and remove the flash drive.

2.5.2. SETUP>EVENTS

Events are occurrences that relate to any operating function and are used to define the conditions that can be set to trigger Alerts (Section 2.4.3). Events can provide diagnostic information about the instrument, typically referred to as “Warnings”, or they can provide other information on instrument functionality, such as concentration alarms. Some Events are standard and not editable while others are user-configurable, described here. Existing Events are listed in the Events page (Figure 2-29) under the Setup menu.

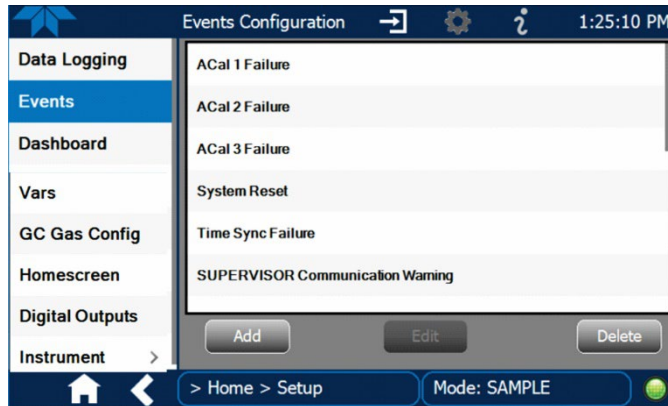

Figure 2-29. Example Events List

Access the Events Configuration page either from the Active Alerts page (Alerts Menu) by pressing the configuration button, or through the Home>Setup>Events menu (Figure 2-29). Press ADD to create a new Event (refer to Figure 2-30 for details), or select an existing Event to either Edit or Delete it (Figure 2-32).

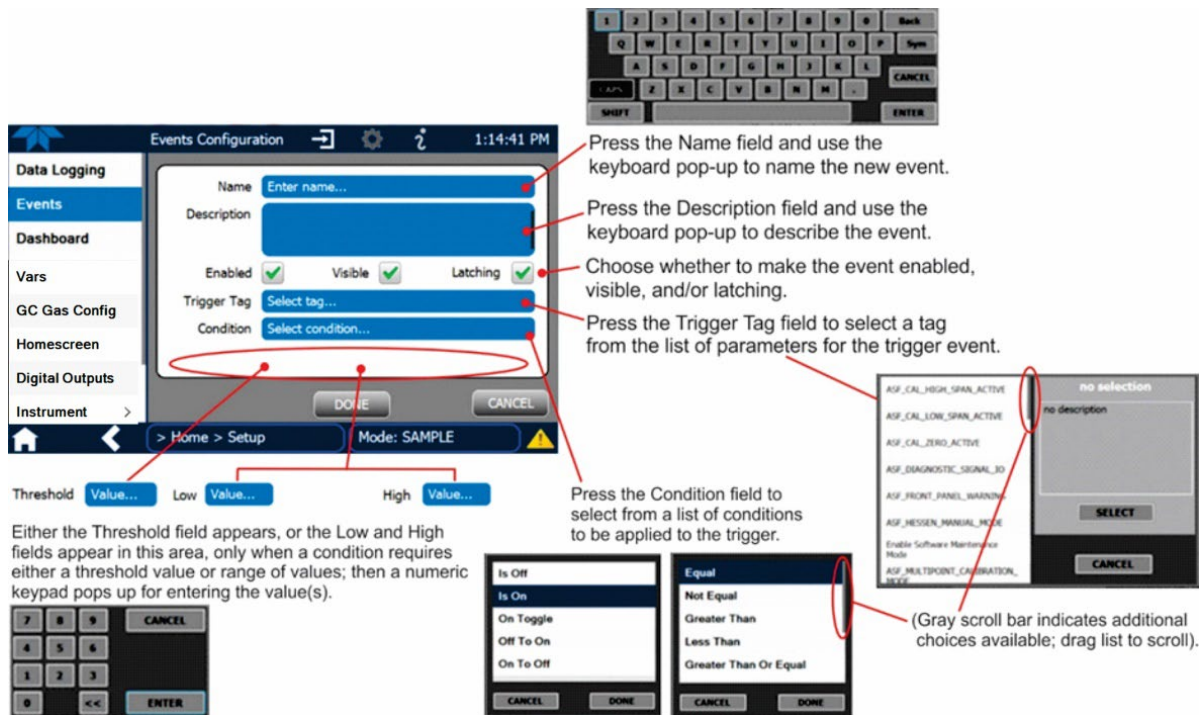

Figure 2-30. Event Configuration

- Enabled allows the choice of whether to track and record the Event (uncheck this box to “turn off” or deactivate the Event without deleting it). An Event must be enabled in order to use the Visible and the Latching options.
- Visible allows the choice of whether or not to display the Event in the Alerts page when it is triggered (it will still be recorded and can be viewed in the Utilities>Alerts Log). To use this option, the Event must be enabled.
- Latching allows the choice of whether or not to keep an Event visible even if the conditions that triggered it were to correct themselves. (Latching requires that the user interact with the Active Alerts screen to manually clear the Alert and internal Event state. Non-latching allows the entry in the Active Alerts screen and the internal Event state to continuously update based on the Event criteria, requiring no user interaction to clear the Alert or Event state).

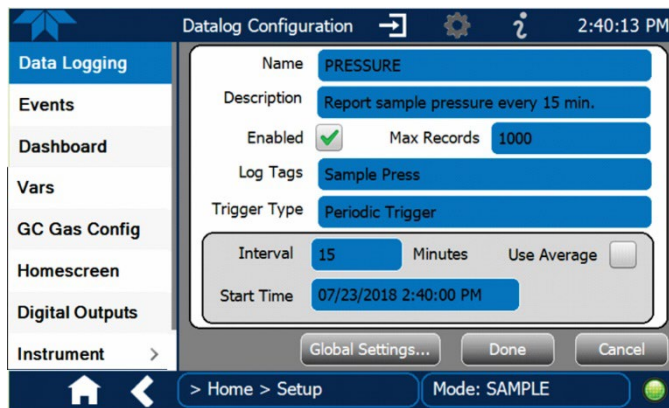
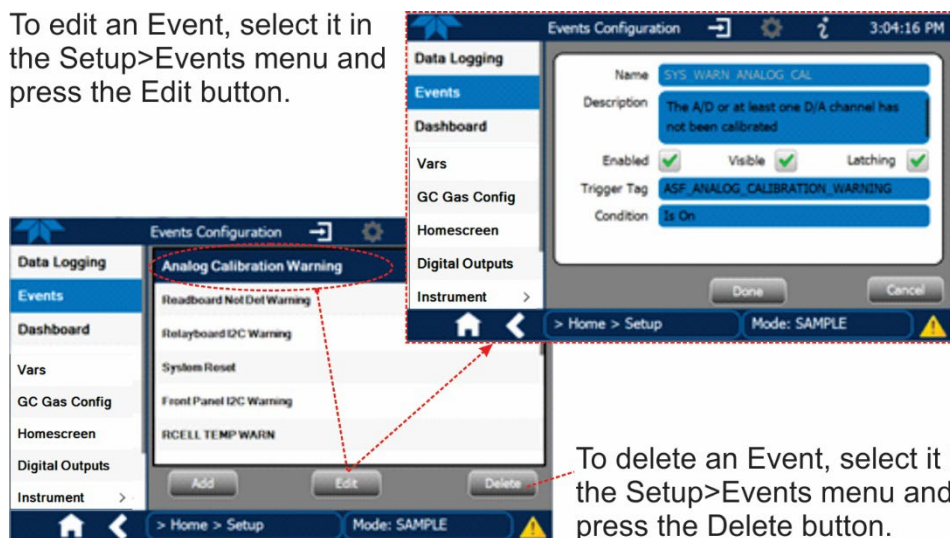

Figure 2-31. Configured Event Sample

2.5.2.1. EDITING OR DELETING EVENTS

Select an Event from the list (Figure 2-29) and press the Edit button to view or edit the details (Figure 2-31), or press the Delete button to delete the Event.

To edit an Event, select it in the Setup>Events menu and press the Edit button.



To delete an Event, select it in the Setup>Events menu and press the Delete button.

Figure 2-32. Edit or Delete an Event

2.5.2.2. USING EVENTS AS TRIGGERS FOR DATA LOGGING

Events can also be used to create customized triggers for data logging functions. The name entered in the Name field of the Events Configuration page will appear in the list of Log Tags of the Datalog Configuration page. The Data Logger is presented in Section 2.5.1.

2.5.3. SETUP>DASHBOARD

To navigate to the Dashboard Configuration page either press the configuration shortcut from the Dashboard page, or use the Setup>Dashboard menu.

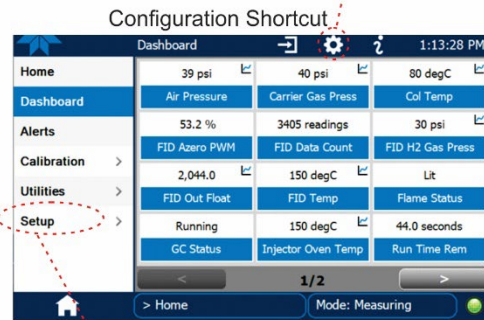

Configuration Editing:

To add a parameter to the Dashboard, select it in the "Available Tags" list and press the right-pointing arrows button. (Checkmarks in the "Available Tags" list indicate parameters that are currently in the Dashboard).

To remove a parameter from the Dashboard, select it from the "Dashboard" list and press the left-pointing arrows button.



Figure 2-33. Dashboard Display and Configuration

2.5.4. SETUP>AUTOCAL (WITH VALVE OPTION)

Auto Cal is available with installed valve options for use in performing an automatic span calibration check (see Section 4.3).

2.5.5. SETUP>VARS

Vars are user-adjustable software variables that define operational parameters automatically set by the instrument's firmware. Table 2-8 lists and describes the key Vars for this instrument along with their default values; Table 2-9 lists and describes general Vars. Access the menu to see the list of variables; select a variable to view its description; use the Edit button to change its setting(s).

Table 2-8. Key Variables with Default Values and Descriptions

VAR NAME	DEFAULT VALUE	DESCRIPTION
Acquisition Time	25 s	The total time for capturing data during each run of Measurement mode
Bakeout Acquisition time	25 s	The total time for capturing data during each run of Bakeout mode
Bakeout Col2 Initial Hold	25 s	The duration for maintaining the initial column temperature at the start of Bakeout mode
Bakeout Col2 Initial Temp	80 degC	The initial column temperature at the start of Bakeout mode
Bakeout Col2 Ramp1 Hold	30 s	The duration for maintaining the temperature reached when the column is heated up during Bakeout mode
Bakeout Col2 Ramp1 Rate	3 degC/s	The DegC/Sec rate at which the column is heated up during Bakeout mode
Bakeout Col2 Ramp1 Temp	285 degC	The setpoint that the column temperature reaches during Bakeout mode
Bakeout Interval	6 hr	The wait time between each automatic Bakeout
Bakeout Pump time	5 s	The period of running the DC pump at the start of Bakeout mode
Bakeout Runs	1	The total number of times that the bakeout function runs during each Bakeout Interval
* Carrier Gas Initial Press	40 psi	The carrier gas pressure
CH4->THC Comp	0.9	CH4 to THC channel factor
Col2 Initial Hold	45 s	The duration for maintaining the initial column temperature at the start of Measurement mode
Col2 Initial Temp	80 degC	The initial column temperature at the start of Measurement mode
Col2 Ramp1 Hold	1 s	The duration for maintaining the temperature reached when the column is heated up during Measurement mode
Col2 Ramp1 Rate	0 degC/s	The DegC/Sec rate at which the column is heated up during Measurement mode
Col2 Ramp1 Temp	80 degC	The setpoint that the column temperature reaches during Measurement mode
Cont Results Export	TRUE	Enable the continuous results table
DC Pump Fill Time	10 s	The period of running the DC pump at Measurement mode
Enter Bakeout Control	FALSE	Manually enter the Bakeout mode
Enter Standby Control	FALSE	Manually enter the Standby mode
Exit Standby Control	FALSE	Manually exit the Standby mode

VAR NAME	DEFAULT VALUE	DESCRIPTION
* FID Air Ignite Pressure	13.2 psi	FID Air-Ignite pressure
* FID Air Run Pressure	38.8 psi	FID Air-Running Pressure
FID Flame Check	1	Enable the flame check threshold
* FID Flame Check Thresh	53	Flame Threshold
* FID H2 Pressure	30 psi	FID Hydrogen pressure
FID Temperature Set	150 degC	FID temperature
Integration Mode	Area	Mode of integration (Area vs Height)
Oven Temp Set Points	150 degC	Temperature that the injector oven is set to.
PRIGAS Precision	0	Sets the number of significant digits to the right of the decimal point display of primary gas concentration and stability values. ("PRIGAS" = primary gas with two or more other gases; "SECGAS" = secondary gas)
Switch Time Valve Position A1	5 s	The amount of time for turning the switch valve to position B
Switch Time Valve Position B1	25 s	The amount of time for turning the switch valve to position A
THC O2 Area	5500	Oxygen peak area offset

* Value specific to this detector

Table 2-9. Common Variables with Descriptions

VARIABLE	DESCRIPTION
<p>This list includes several of the most common Vars; selecting any Var in the NumaView™ software interface will display its description in the information field to its right. Depending on configuration, some, all, or more of these variables appear in your instrument's Vars menu.</p>	
Background Periodic Report Upload	Allows/disallows uploading of basic functionality reports to a Web services "cloud" for TAPI Technical Support to view. (Frequency can be edited in Setup>Vars>Report Upload Interval).
Daylight Savings Enable	Enable or disable Daylight Savings Time (also see Setup>Instrument>Date/Time Settings)
Instrument ID	Set unique identifier number for the instrument when it is connected with other instruments on the same Ethernet LAN, or when applying MODBUS protocol.
Maint Mode	Enables (True) or does not enable (False) the trigger for software maintenance mode for the duration set in the Maintenance Mode Timeout Var..
Maintenance Mode Control	Specifies whether maintenance is to be controlled in Software mode (used in conjunction with the Maint Mode Var being set to True and the Maintenance Mode Timeout var being set to a time limit being set in ""), Switch mode (hardware switch behind front panel), or Both software and switch modes, or None.
Maintenance Mode Timeout	Sets the duration of software controlled maintenance after which amount of time the instrument is taken out of maintenance mode.
Periodically Check for Updates	Set this parameter to True for the instrument to check the cloud platform for firmware updates via the Internet.
PRIGAS Precision	Sets the number of significant digits to the right of the decimal point display of primary gas concentration and stability values. ("PRIGAS" = primary gas with two or more other gases; "SECGAS" = secondary gas)

VARIABLE	DESCRIPTION
Report Upload Interval	Set the frequency in number of hours at which the instrument's functional conditions are uploaded to the cloud platform (default, 168 hours, generates a weekly report).
SECGAS Precision	Sets the number of significant digits to the right of the decimal point display of secondary gas concentration and stability values. ("PRIGAS" = primary gas with two or more other gases; "SECGAS" = secondary gas)
System Hours	Total runtime hours for the system (similar to a car's total miles vs trip miles).
System Service Interval	Set the number of hours until the next service is due.
Time Since Last Service	Tracks the number of hours since the instrument was most recently serviced.
Upload Report to Cloud	For immediate upload of functionality report to cloud before next interval upload.

2.5.6. SETUP>GC GAS CONFIG

This menu is for adjusting the integration engine of the software, typically where the peak starts and ends for a gas. Select the gas, then select the parameter to adjust (the lower right area of the interface provides a brief description) and press the Edit button to make the adjustment. Figure 2-34 shows a sample screen for this menu.

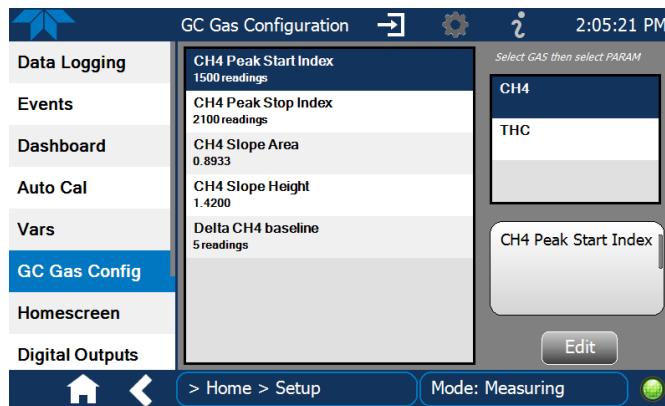

Figure 2-34. GC Gas Configuration

2.5.7. SETUP>HOMESCREEN

To select a parameter (“tag”) for display in each of the three meters at the bottom of the Home page, navigate to the Homescreeen configuration page through either the Setup>Homescreeen menu or from Home page using the configuration icon (Figure 2-35).



Figure 2-35. Homescreeen Configuration

An orientation to the Homescreeen was presented in Section 2.4.1, including Figure 2-17 and Figure 2-18.

2.5.8. SETUP>DIGITAL OUTPUTS (OPTION)

Specify the function of up to five digital outputs and three relays (connected through the rear panel Digital I/O connector, Figure 2-5) by mapping the outputs to a selection of “Signals” present in the instrument. Create custom “Signals” in the Setup>Events menu (Section 2.5.2).

To specify the outputs and/or relays, select a pin in the Outputs list, then make a selection from the Signals list and press the Map button; if/as needed, change the polarity by pressing the Polarity button. Save any changes by pressing the Apply button, or discard the changes by pressing the Home or the back button (a pop-up provides a warning that the changes will be lost, and will prompt for confirmation to apply changes or not).

Navigate to the Utilities>Diagnostics>Digital Outputs menu to change the state (ON/OFF) of individual digital outputs.

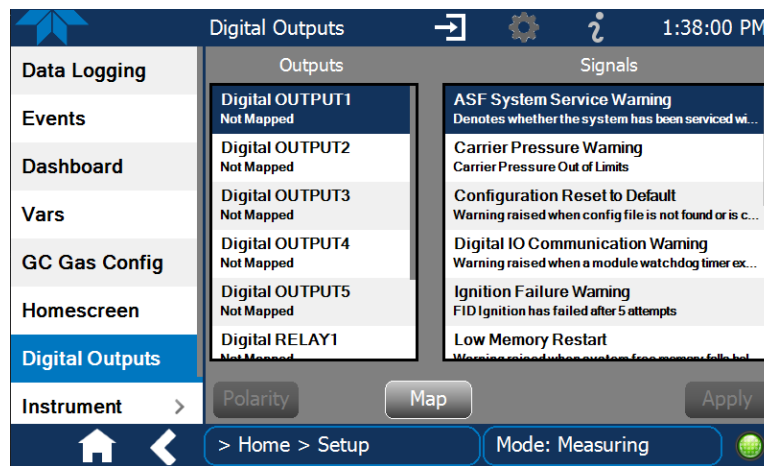

Figure 2-36. Digital Outputs Setup

2.5.9. SETUP>INSTRUMENT

As presented in Table 2-10, view product and system information and network settings, edit network settings, and perform certain maintenance tasks.

Table 2-10. Setup>Instrument Menu

MENU	DESCRIPTION
Product Info	View Model, Part, and Serial Numbers and Package and Driver Versions, and options information.
System Info	View Windows and RAM information.
Module Info	Shows the model and serial number of each module included.
Network Settings	View the network settings (configurable through the Setup>Comm>Network Settings menu).
Date/Time Settings	Adjust date, hour, and minutes, select a time zone*, and set the system clock to automatically adjust for Daylight Savings Time or not. (Also see Setup>Vars>Daylight Savings Enable). *Time Zone change requires a special procedure; see Maintenance Section 5.4.
NTP Time Settings	Configure Network Time Protocol settings for clock synchronization.
Language	Select an available language.
Remote Update	When an instrument is connected to a network that is connected to the Internet, follow the instructions on this Remote Update page to check for and activate software/firmware updates. (Also refer to Section 5.2).

2.5.10. SETUP>COMM (COMMUNICATIONS)

This menu is for specifying the various communications configurations.

2.5.10.1. COM1

Configure the instrument's COM port to operate in modes listed in Table 2-11.

Table 2-11. COM1 Setup

MODE	DESCRIPTION
Baud Rate	Set the baud rate.
Command Prompt Display	Enable/disable a command prompt to be displayed when in terminal mode.
Data Bits	Set the data bits to 7 or 8 (typically set in conjunction with Parity and Stop bits).
Echo and Line Editing	Enable/disable character echoing and line editing.
Handshaking Mode	Choose SOFTWARE handshaking for data flow control (do NOT use SOFTWARE handshaking mode when using MODBUS RTU for Protocol mode; select only HARDWARE or OFF for MODBUS RTU), or HARDWARE for CTS/RTS style hardwired transmission handshaking. (This style of data transmission handshaking is commonly used with modems or terminal emulation protocols). Or choose to turn OFF handshaking.
Hardware Error Checking	Enable/disable hardware error checking.
Hardware FIFO	Enable/disable the hardware First In – First Out (FIFO) for improving data transfer rate for that COM port.

MODE	DESCRIPTION
Modem Connection	Select either a modem connection or a direct cable connection.
Modem Init String	Input an initialization string to enable the modem to communicate.
Parity	Select odd, or even, or no parity (typically set in conjunction with Data Bits and Stop Bits).
Protocol	Select between the communications protocols: MODBUS RTU or MODBUS ASCII
Quiet Mode	Enable/disable Quiet mode, which suppresses any feedback from the analyzer (such as warning messages) to the remote device and is typically used when the port is communicating with a computer program where such intermittent messages might cause communication problems. Such feedback is still available, but a command must be issued to receive them.
Security	Enable/disable the requirement for a password for this serial port to respond. The only command that is active is the request-for-help command, ? CR .
Stop bits	Select either 0 or 1 stop bit (typically set in conjunction with Parity and Data bits).

2.5.10.2. TCP PORT1

TCP Port1 allows choosing whether or not to display the command prompt, editing the Port 1 number for defining the terminal control port by which terminal emulation software addresses the instrument, such as Internet or NumaView™ Remote software, and enabling or disabling security on this port.

2.5.10.3. TCP PORT2

TCP Port2 is configured with the port number for MODBUS.

2.5.10.4. NETWORK SETTINGS

The Setup>Comm>Network Settings menu is for Ethernet configuration. The address settings default to automatic configuration by Dynamic Host Configuration Protocol (DHCP). Most users will want to configure the instrument with a static IP address: click the Static radio button to manually assign a static IP address (consult your network administrator and see Table 2-12 for information).

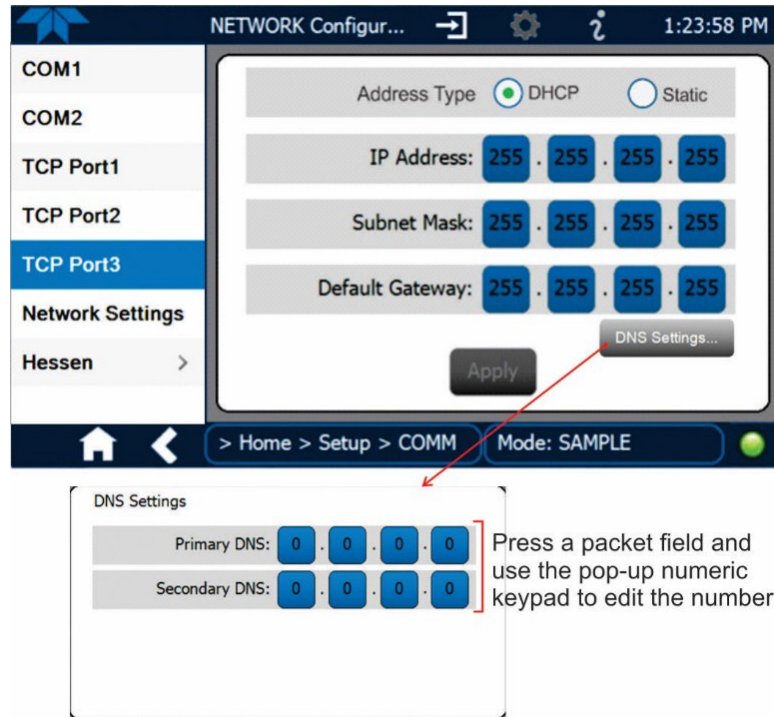

Figure 2-37. Communications Configuration, Network Settings

Table 2-12. LAN/Ethernet Configuration Properties

PROPERTY	DESCRIPTION
IP address	A string of four packets of 1 to 3 numbers each (e.g. 192.168.76.55.) is the internet protocol address of the instrument itself.
Subnet Mask	A string of four packets of 1 to 3 numbers each (e.g. 255.255.252.0) number that masks an IP address, and divides the IP address into network address and host address and identifies the LAN to which the device is connected. All addressable devices and computers on a LAN must have the same subnet mask. Any transmissions sent to devices with different subnets are assumed to be outside of the LAN and are routed through the gateway computer onto the Internet.
Default Gateway	A string of numbers very similar to the Instrument IP address (e.g. 192.168.76.1) that is the address of the computer used by your LAN and serves as a router to access the Internet or another network.

2.6. TRANSFERRING CONFIGURATION TO OTHER INSTRUMENTS

Once an instrument is configured, the same configuration can be copied to other instruments of the same Model. This encompasses essentially anything the user can configure and does not apply to instrument-specific settings such as those that are configured at the factory for calibration.

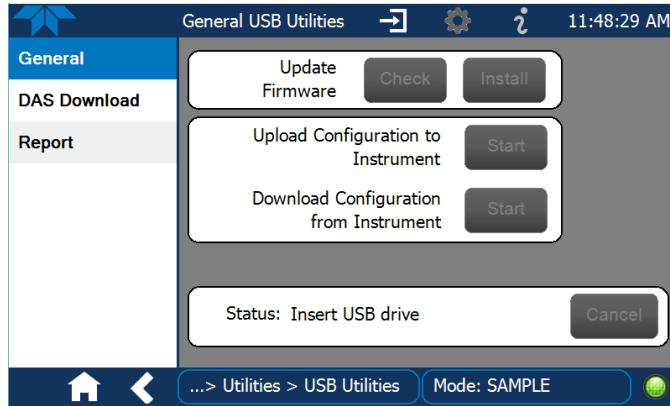

Figure 2-38. Configuration Transfer

1. In the source instrument, go to the Home>Utilities>USB Utilities>General page.
2. Insert a flash drive into either of the two front panel USB ports.
3. When the Status field Indicates that the USB drive has been detected, press the “Download Configuration from Instrument” Start button.
4. When the Status field Indicates that the download is complete, remove the flash drive.
5. In the target instrument, go to the Home>Utilities>USB Utilities>General page.
6. Insert a flash drive into either of the two front panel USB ports.
7. When the Status field Indicates that the USB drive has been detected, press the “Upload Configuration to Instrument” Start button.
8. When the Status field Indicates that the upload is complete, remove the flash drive.

3. COMMUNICATIONS AND REMOTE OPERATION

This instrument's rear panel connections include an Ethernet port and a serial communications port. Connection instructions were provided in Section 2.3.1.4. Configuration information was provided in Section 2.5.10.

Data acquisition is set up through the Datalogger (Section 2.5.1).

3.1. SERIAL COMMUNICATION

The rear panel COM port operates on the RS-232 protocol (default configuration is DCE RS-232), or it can be configured for DTE RS-232 (Section 2.3.1.4).

Referring to Table 2-11, use the SETUP>COMM menu to view/edit the communications settings for the COM port.

3.2. ETHERNET

When using the Ethernet interface, the analyzer can be connected to any Ethernet network via low-cost network hubs, switches or routers. The interface operates as a standard TCP/IP device on port 3000. This allows a remote computer to connect through the network to the analyzer using NumaView™ Remote, terminal emulators or other programs.

The Ethernet connector has two LEDs that are on the connector itself, indicating its current operating status.

Table 3-1. Ethernet Status Indicators

LED	FUNCTION
green (link)	On when connection to the LAN is valid.
amber (activity)	Flickers during any activity on the LAN.

The analyzer is shipped with DHCP enabled by default. This allows the instrument to be connected to a network or router with a DHCP server; however, it should be configured with a Static IP address as soon as practical. See Section 2.5.10.4 for configuration details.

3.3. NUMAVIEW™ REMOTE

For remote operation and data capture through an Ethernet connection, please refer to the NumaView™ Remote Software User Guide, PN 08492, available on our website.

4. CALIBRATION

This section is organized into subsections as follows:

SECTION 4.1 – Important Precalibration Information: contains important information you should know before calibrating the instrument.

SECTION 4.2 – Calibration Procedures: describes the procedure for manually checking calibration and performing actual calibration of the instrument.

SECTION 4.3 – Automatic Span Cal Check (Auto Cal): describes the procedure for using the AutoCal feature to check calibration or to calibrate the instrument. (The AutoCal feature requires that the span cal valve option be installed and operating).

4.1. IMPORTANT PRECALIBRATION INFORMATION

Note

A start-up period of 1-2 hours is recommended prior to calibrating the analyzer.

4.1.1. CALIBRATION REQUIREMENTS

The following equipment, supplies, and expendables are required for calibration:

- Zero air supply Zero Air Generator (i.e. T701H) or Zero Air Cylinder (with purity and pressure spec)
- Span gas source (Recommended VOC cylinder mixture with balance, including concentrations and pressure)
- Carrier gas source (Recommended with purity and pressure spec)
- Fuel gas source (Hydrogen Generator or Cylinder (with purity and pressure spec)
- Auxiliary air (Air type and pressure spec)
- Gas lines - all sample and calibration gas line materials should be stainless steel or Teflon-type (PTFE or FEP).

Optional equipment:

Calibrator (e.g., T700) for diluting the span gas and sample it to the analyzer. A recording device such as a strip-chart recorder and/or data logger.

For electronic documentation, the internal data acquisition system (DAS) can be used by configuring the Datalogger through the Setup>Data Logging menu; Section 2.5.1).

The method for performing an initial calibration for the analyzer differs between the standard instrument and those with options.

- See Section 4.2.1 for instructions for initial calibration of the analyzer in its base configuration.
- See Section 4.2.2 for information regarding setup and calibration of the analyzer with the Span Calibration Valve option.

Note

Zero air and span gases must be supplied at least at a 1 LPM gas flow rate.

4.1.2. ZERO AIR

Zero air free of hydrocarbon is required for the calibration. A zero generator with an HC scrubber option, such as the Teledyne API Model 701H, can be used.

4.1.3. CALIBRATION (SPAN) GAS

Hydrocarbon cylinder gas diluted with zero air is required for the calibration process. Nitrogen can also be used when THC O2 Comp is turned off (Setup>GC Gas Config>THC O2 Comp Enab, edit to set to False; Figure 4-1). You could use the T700 calibrator to match the desired range. Thus, it is recommended that the span gas is of a concentration equal to 80% of the measurement range for your application.

CAUTION!



Use a low level, handheld H2 leak detector, such as the Restek Electronic Leak Detector, to check for H2 leaks at the cylinder regulator when a cylinder is replaced, and around the external connections any time they are disconnected.
If the presence of Hydrogen gas is detected at any time, power down the instrument and contact Teledyne API Technical Support as soon as possible:
+1 800-324-5190 or email: api-techsupport@teledyne.com

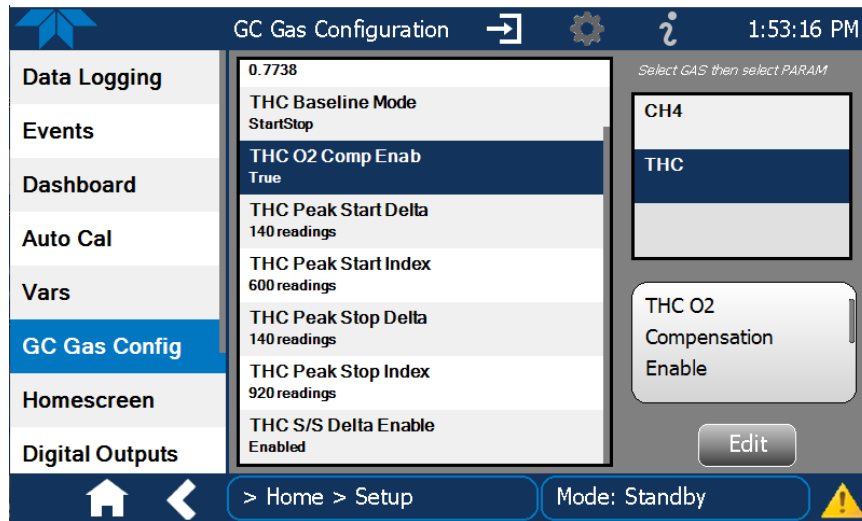

Figure 4-1. Reconfiguration when Nitrogen Used as Span Gas

4.1.4. DATA RECORDING DEVICES

A strip chart recorder, data acquisition system or digital data acquisition system should be used to record data from either the Ethernet, serial or analog outputs.

- If analog readings are used, the response of the recording system should be checked against a NIST traceable voltage source or meter.
- Data recording devices should be capable of bi-polar operation so that negative readings can be recorded.

For electronic data recording, the analyzers provide an internal data logger, which is configured through the Setup>Data Logger menu (Section 2.5.1).

NumaView™ Remote (Section 3.3) is a remote control program, which is also available as a convenient and powerful tool for data viewing and handling, download, storage, quick check and plotting.

4.2. CALIBRATION PROCEDURES

Check that the pneumatic connections for the specific instrument configuration are as instructed in Section 2.3.2.

Note

The span gas concentration should be 80% of range of concentration values likely to be encountered in your application.

To calibrate or to perform a calibration check for basic configuration instruments, see Section 4.2.1.

To calibrate or to perform a calibration check for instruments with the span cal valve option, see Section 4.2.2.

4.2.1. CALIBRATION AND CHECK PROCEDURES FOR BASIC CONFIGURATION

Although this section uses the Calibration menu for both calibration check and actual calibration, a check does not require the Calibration menu. Instead, while in Home page, simply flow the zero air or the span gas through the Sample port and check the reading after about five minutes (either in the gas graph or in the Dashboard).

Otherwise, use the procedures presented in Sections 4.2.1.1 and 4.2.1.2.

4.2.1.1. O₂ CALIBRATION

The THC peak is a measurement of oxygen, methane, and non-methane, combined into a single peak. It is important to perform an O₂ Calibration at startup and periodically (every ~3 months) during operation. This Calibration calculates a fixed offset for the O₂ contribution to the peak, which gets subtracted during each subsequent measurement.

1. Begin by providing zero-air to the instrument under atmospheric pressure at the sample port. The instrument should be in measurement mode. Allow sufficient time for the analyzer readings to stabilize, typically 10-15 minutes.
2. Navigate to Calibration>O₂ Cal. Observe two values, O₂ Area Stored and O₂ Area Meas. O₂ Area Stored is the current oxygen compensation factor from the last O₂ Calibration. O₂ Area Meas is the area of the THC peak currently, which should be devoid of THC contributions since the analyzer is sampling zero-air.
3. Once this value is stabilized, press the Calibrate button. This stores the area value in the VARS labeled “THC O₂ Area.” The Cal status will change to True.

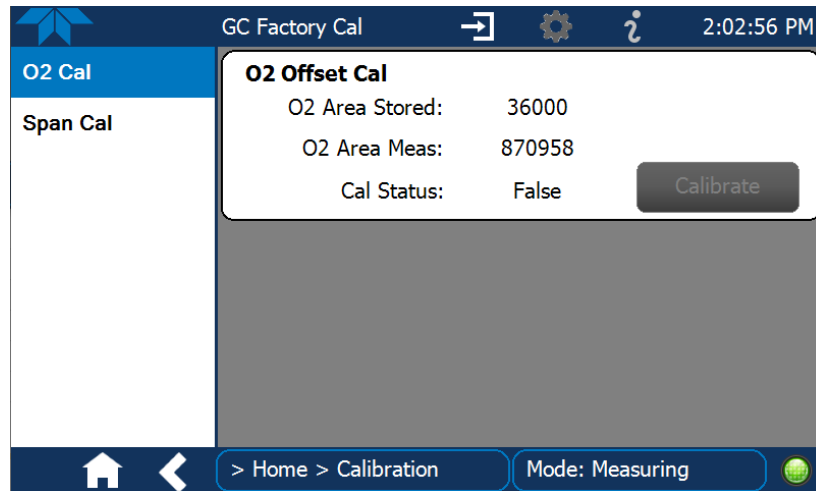

4.2.1.2. CH4 CALIBRATION

The N901 measures NMHC by subtracting the CH4 peak from the THC/O2 peak . It is important to establish the relationship between these two peaks when sampling Methane only. For this reason, it may be necessary upon startup, and periodically after, to run a Methane-only calibration. A Methane standard should be delivered under atmospheric pressure to the Sample inlet, and a concentration of ~ 80% of the operating range. For example, if the operating range of the analyzer is 0-10 ppm, a Methane concentration of 8 ppm in balance air should be generated using either a dilution calibrator or a cylinder of Methane with a Methane concentration of 8 ppm in balance air (not balance N₂). If using a dilution calibrator, it is acceptable to use a cylinder of Methane in either balance N₂ or balance air, since the calibrator will dilute the gas with Air.

1. In the Calibration>Span Cal menu, input Span gas through the Sample port, allowing it to run for at least 10 minutes, then press the Start button. (This will help to improve the accuracy of the calibration).

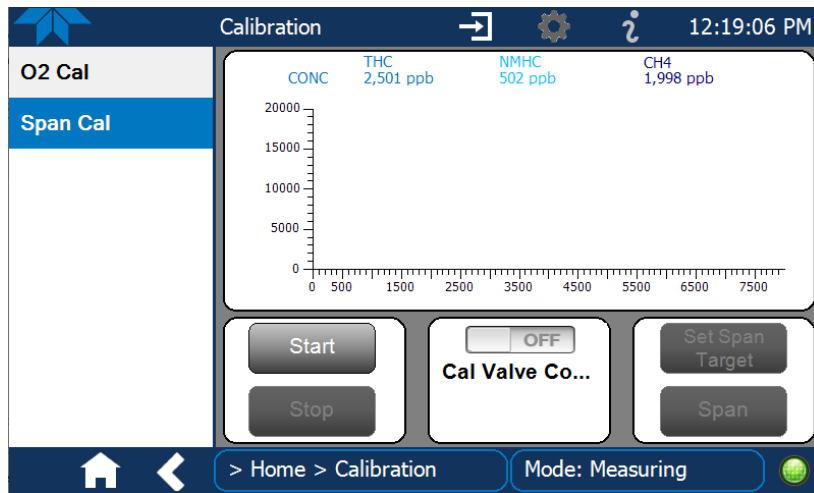

2. Click the “Set Span Target” button.
3. In the Span Target page, uncheck the NMHC box, and check the CH4 box,

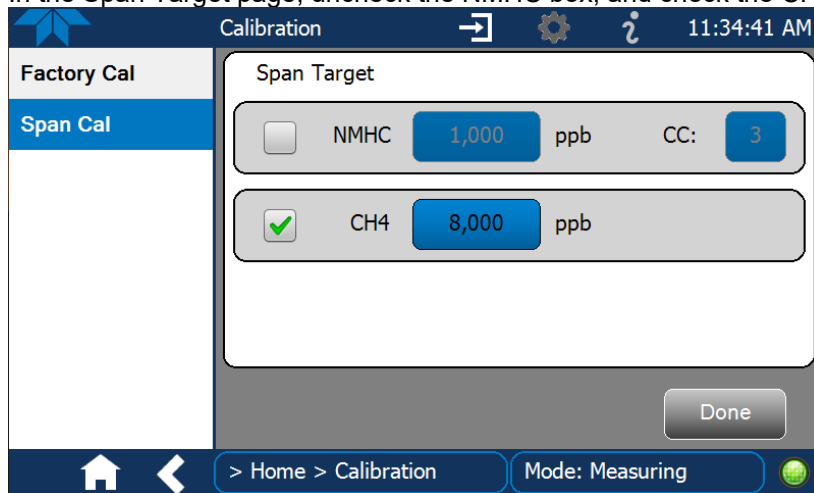

4. Click the blue button in the CH4 field to input the concentration of gas being delivered to the instrument, and click Enter when complete.

5. Click Done to return to the Span Cal page.
6. Press the Span button to complete the calibration.

Note

The CH₄, NMHC, and THC values will not immediately be updated to the new calibrated concentrations until after the completion of a full measurement cycle following this span adjustment.

4.2.1.3. NMHC CALIBRATION

Following the O₂ Calibration (Section 4.2.1.1) and the Methane-only (CH₄) Calibration (Section 4.2.1.2), or any time the instrument drifts outside of acceptable limits, it will be necessary to perform a span calibration for the Methane and non-methane channels. This could be applied by using only NMHC cylinder (Like Propane, or Benzene, etc.), or by using a blend gas cylinder containing Methane and non-methane Hydrocarbon (Like Propane). Note that if a dilution calibrator is not used (i.e. span or check bottle), the bottle should be balanced in Air. If using a dilution calibrator, the bottle may be balanced in Air or nitrogen.

4.2.1.3.1 NMHC CALIBRATION WITH NMHC-ONLY CYLINDER

1. Start sampling the NMHC sample with 80% of the target range, allowing it to run at least 10 minutes to help improve calibration accuracy.
2. In the Calibration > Span Cal and press the Start button.
3. Click the “Set Span Target” button.
4. In the Span Target page, check the NMHC box and ensure that the CH₄ box is unchecked.
5. Click the blue button for the NMHC concentration, input the target gas value and click Enter.
6. Click the blue button for the carbon count (CC), input the carbon count of the NMHC gas, and press Enter. As an example, enter 3 for Propane (C₃H₈). This value will ensure the NMHC channel is calibrated for ppbC (parts per billion carbon).

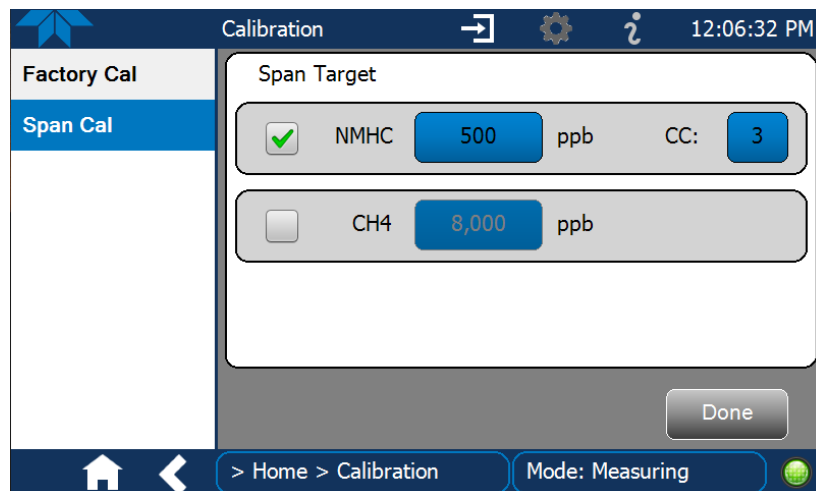

(Example for 500 ppb Propane and 3 ppb Carbon)

7. Press Done to return to the Span Cal page.
8. Press the Span button to complete the calibration.

Note

The CH₄, NMHC, and THC values will not immediately be updated to the new calibrated concentrations until after the completion of a full measurement cycle following this span adjustment.

4.2.1.3.2 NMHC CALIBRATION WITH BLEND CYLINDER

1. Start sampling the Blend sample with 80% of the target range, allowing it to run at least 10 minutes to help improve calibration accuracy.
2. In the Calibration > Span Cal and press the Start button.
3. Click the “Set Span Target” button.
4. In the Span Target page, check both the CH₄ and the NMHC boxes.
5. Click the blue button for the NMHC concentration, input the target gas value, and click Enter.
6. Repeat for the CH₄ concentration.
7. Click the blue button for the carbon count (CC), input the carbon count of the NMHC gas, and press Enter. As an example, enter 3 for Propane (C₃H₈). This value will ensure the NMHC channel is calibrated for ppbC (parts per billion carbon).

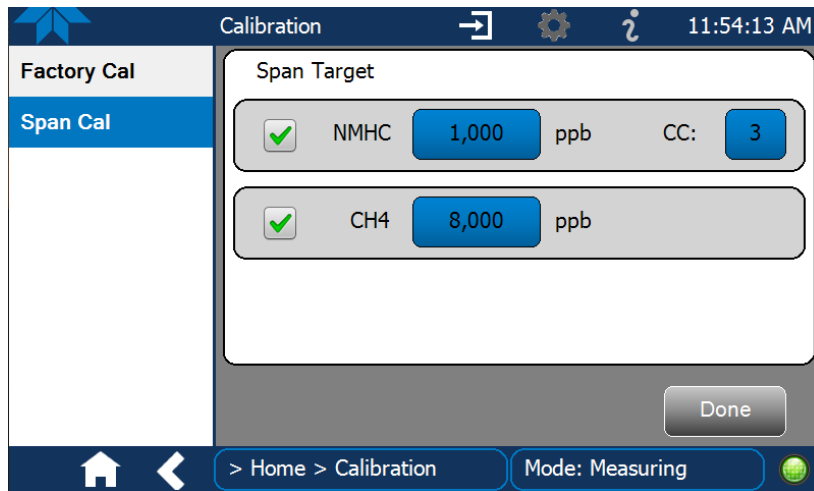

(Example for 8000 ppb Methane, 1000 ppb Propane, and 3 ppb Carbon)

8. Press Done to return to the Span Cal page.
9. Press the Span button to complete the calibration.

Note

The CH₄, NMHC, and THC values will not immediately be updated to the new calibrated concentrations until after the completion of a full measurement cycle following this span adjustment.

4.2.2. CALIBRATION AND CHECK PROCEDURES WITH SPAN CAL VALVE AND DIGITAL EXPANSION BOARD OPTIONS INSTALLED

Digital inputs are available for controlling calibration checks when the Digital I/O Expansion Board option is installed. Instructions for setup and use of this board option are in Section 2.3.1.3.

When the Digital Inputs are activated for at least 5 seconds, the instrument switches into high span mode and the internal cal valve will be automatically switched to the appropriate configuration.

- The remote calibration Digital Inputs may be activated in any order.
- It is recommended that the Digital Inputs remain closed for at least 10 minutes to establish a reliable reading.
- The instrument will stay in the selected mode for as long as the Input remains closed.

If Digital Inputs are being used in conjunction with the analyzer’s AutoCal (see Section 4.3) feature, and the AutoCal attribute “Enabled” box is checked, the analyzer will check the span calibration when n Input is opened; then the check value will be recorded and the instrument will return to Measuring mode.

If the AutoCal attribute “Enabled” box is unchecked, the instrument will return to Measuring mode without checking the span calibration.

4.3. AUTOMATIC SPAN CAL CHECK (AUTO CAL)

The Auto Cal feature allows unattended periodic operation of the Span Cal Valve option by using the instrument’s internal time of day clock. Auto Cal operates by executing preprogrammed span calibration checks set up by the user to open and close the valve appropriately. It is possible to set up and run up to three separate preprogrammed calibration checks (labeled # 1, 2 and 3).

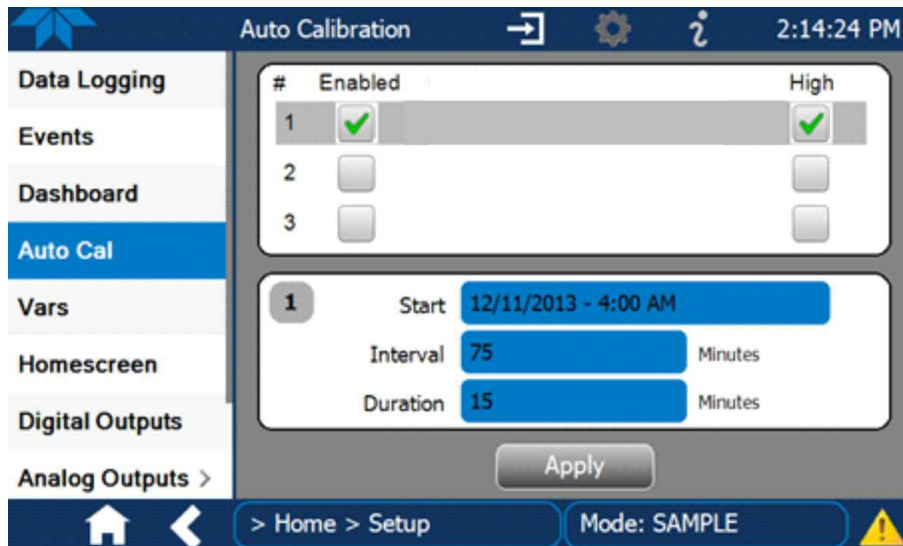

Figure 4-2. Auto Cal Page

There are four parameters that control operational details: Date, Time (both in the Start field), Interval, and Duration, as presented in Table 4-1.

Table 4-1. Auto Cal Programming Sequence Execution

ATTRIBUTE	ACTION
Start	When the Enabled box is “on” <input checked="" type="checkbox"/> , the Sequence (identified by its number) begins on the date and time shown in the configurable Start field. (Click the field for the pop-up window and toggle between the Time (Hour/Minutes) and the Date (Year/Month/Day) attributes to edit as needed).
Interval	Number of minutes to skip between each Sequence execution. (Click the field to input the number of minutes in the pop-up window).
Duration	Number of minutes that each Sequence execution is to run. (Click the field to input the number of minutes in the pop-up window).

Important

IMPACT ON READINGS OR DATA

- **The programmed STARTING_TIME must be a minimum of 5 minutes later than the real time clock. (For setting real time clock, see Setup>Instrument, Section 2.5.8).**
- **Avoid setting two or more span cal checks at the same time of the day.**
- **Any new span cal check that is initiated, whether from a timer, the COM ports or the contact closure inputs, will override any sequence that is in progress.**

5. MAINTENANCE AND SERVICE

Although this instrument requires little service, a few simple procedures can be performed to ensure that it continues to operate accurately and reliably over its lifetime. In general, the exterior can be wiped down with a lightly damp cloth. Service and troubleshooting are covered in Section 5.5.

ATTENTION

COULD DAMAGE INSTRUMENT AND VOID WARRANTY
Avoid spraying anything directly onto any part of the analyzer.

5.1. MAINTENANCE SCHEDULE

Most maintenance can be carried out on an as-needed basis; the actual frequency can vary depending on the operating environment, such as filter replacement. See Section 5.5.7 for items to service. Use Table 5-1 (or similar form) to track which service was performed when. Keep in mind that in some cases, there may be local regulations or standards that also need to be considered.



WARNING – ELECTRICAL SHOCK HAZARD

Disconnect power before performing any of the following operations that require entry into the interior of the analyzer.



CAUTION – QUALIFIED PERSONNEL

These maintenance procedures must be performed by qualified technicians only.

Important

IMPACT ON READINGS OR DATA

A span calibration check can be performed following maintenance procedures. To perform a CHECK of the instrument's Span Calibration, refer to Section 4.2.1.2.

DO NOT press the Span button at the end of each operation (actual calibration), as this will reset the stored values for OFFSET and SLOPE and alter the instrument's calibration.

Alternatively, use the Auto Cal feature described in Section 4.3 to run a span calibration check.

Table 5-1. Maintenance Schedule

ITEM	ACTION	FREQ	CAL CHECK DONE? (Y/N)	DATE PERFORMED													
Filter (Section 5.5.7.3)	replace	as needed															
DC pump (Section 5.5.7.4)	replace	as needed															

5.2. OPERATIONAL HEALTH CHECKS

Navigate to the Utilities>USB Utilities>Report menu (Figure 5-1) to download a report on the basic operations of the instrument. To download the report for your own viewing on a computer or to send to others, insert a flash drive into a front panel USB port and press the Download button, which is enabled when the instrument detects the flash drive.

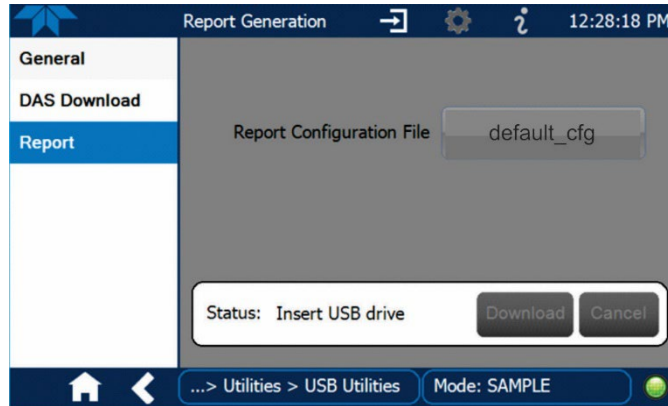

Figure 5-1: Report Generation Page

The report can also be set to generate periodically and sent to a Web services “cloud” where it is available for viewing by Teledyne API technical support personnel. Set this function with two Vars:

Setup>Vars>Upload Report to Cloud: set to True.

Setup>Vars>Report Upload>Interval: edit the number of hours between report uploads.

5.3. SOFTWARE/FIRMWARE UPDATES

There are two ways to check for and acquire updates: either remotely or manually.

5.3.1. REMOTE UPDATES

The instrument must be connected to a network that is connected to the Internet. In the Setup>Instrument menu, select the Remote Update menu and press the Check for Updates button. If an update is available, it can be downloaded through this page, or it can be done remotely (Section 5.3.2).

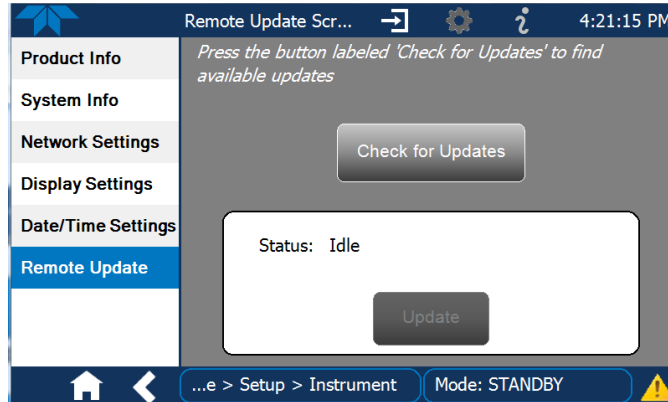

Figure 5-2. Remote Update Page

5.3.2. MANUAL RELOAD/UPDATE PROCEDURES

To reload or update firmware, first contact Technical Support to obtain the applicable file(s): api-techsupport@teledyne.com /+1 800-324-5190.

1. Follow Technical Support’s instructions for copying the firmware files to a flash drive.
2. Go to the Utilities>USB Utilities>General menu.

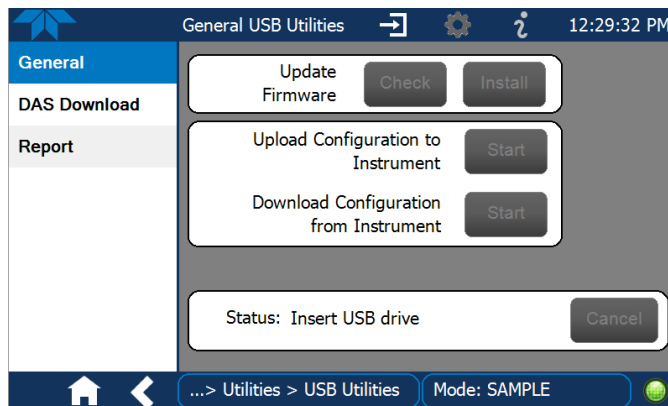

Figure 5-3. Manual Update Page (and other utilities)

3. Insert a flash drive into a front panel USB port and wait for the Status field to Indicates that the drive has been detected.
4. In the Update Firmware field, press the Check button for the instrument to determine whether the firmware on the flash drive is more recent than what is currently installed. Once it’s been determined that the firmware is new, the Install button will be enabled; if the firmware version on the flash drive is the same as or older than the current firmware of the instrument, the Install button will not be enabled.
5. Press the Install button and note the messages in the Status field at the bottom of the page. Use the Cancel button if necessary.
6. When complete, as indicated in the Status field, press the Done button, which replaces the Cancel button, and remove the flash drive.
7. Power off and restart the instrument to complete the new firmware installation.

5.4. TIME ZONE CHANGES

There is an option to change between 12-hour and 24-hour format in the Setup>Vars menu (System Time Format). Effectively changing the Time Zone requires a specific procedure as follows:

1. In Setup>Instrument>Date/Time Settings select the applicable Time Zone.
2. Allow adequate time for the selected Time Zone to be properly accepted.
3. Verify: return to Home page then back to the Date/Time Settings page and check that the selected Time Zone is now highlighted.
4. Without making any other changes, power OFF the instrument and power ON again.
5. Once restarted, return to the Date/Time Settings page where the newly selected Time Zone should be highlighted. (If not, it means that not enough time had passed for the instrument to accept the change before the power was cycled OFF).
6. After the Time Zone is implemented first (Steps 1 through 5), then other changes to the date and/or time can be made, and recycling the power is not necessary.

- ① Time zone change must be set **first**.
- ② **Wait**. Allow sufficient time to accept new Time Zone.
- ③ **Verify**. Return to Home page, then return to Date/Time Settings page.
- ④ After correct Time Zone is displayed, **power recycle** the instrument.
- ⑤ Only after Time Zone is selected and instrument rebooted, can other changes to date and/or time be made effectively.

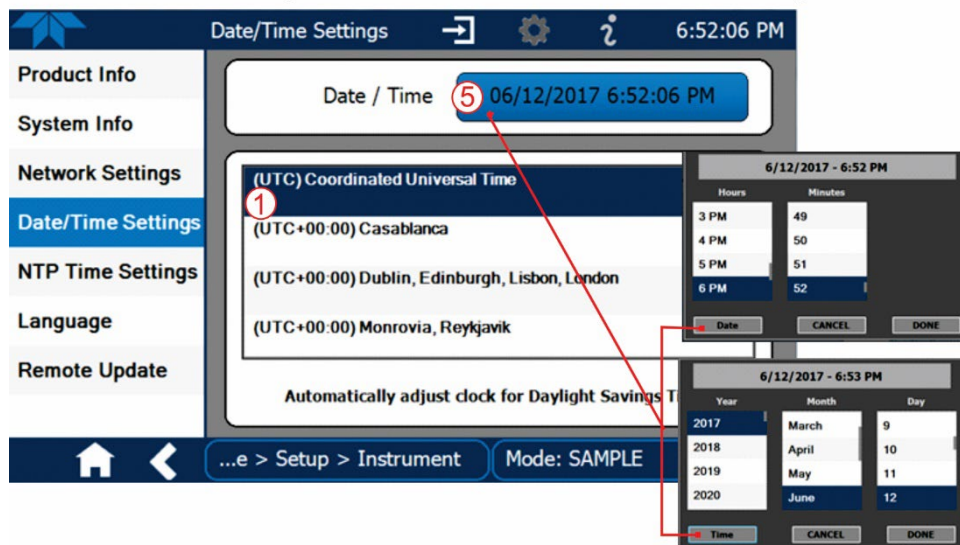

Changes to date and/or time do **not** require a reboot.

Figure 5-4. Time Zone Change Requirements

5.5. SERVICE AND TROUBLESHOOTING

This section contains methods to identify the source of performance problems with the analyzer and procedures to service the instrument.



CAUTION

The operations outlined in this section must be performed by qualified maintenance personnel only.



WARNING – RISK OF ELECTRICAL SHOCK

Some operations need to be carried out with the analyzer open and running.

Exercise caution to avoid electrical shocks and electrostatic or mechanical damage to the analyzer.

Do not drop tools into the analyzer or leave them after your procedures.

Do not short or touch electric connections with metallic tools while operating inside the analyzer.

Use common sense when operating inside a running analyzer.



CAUTION!

Use a low level, handheld H₂ leak detector, such as the Restek Electronic Leak Detector, to check for H₂ leaks any time the unit is opened for serviced, including at the cylinder regulator when a cylinder is replaced, and around the external connections any time they are disconnected.

If the presence of Hydrogen gas is detected at any time, power down the instrument and contact Teledyne API Technical Support as soon as possible:

+1 800-324-5190 or email: api-techsupport@teledyne.com

The analyzer has been designed so that problems can be rapidly detected, evaluated and repaired. During operation, it continuously performs diagnostic tests and provides the ability to evaluate its key operating parameters without disturbing monitoring operations.

A systematic approach to troubleshooting will generally consist of:

- noting any Alerts and taking corrective action as necessary.
- examining the values of all basic functions in the Dashboard and comparing them to factory values, taking corrective action for any major deviations from the factory values.
- checking the internal electronic status LEDs to determine proper operation/functionality (see Figure 5-5).

5.5.1. FAULT DIAGNOSIS WITH ALERTS

Some warning Alerts may occur during start up and typically resolve on their own.

It should be noted that if more than two or three warning Alerts occur at the same time, it is often an indication that some fundamental sub-system has failed rather than an indication of the specific failures referenced by the Alerts.

In addition to being useful as predictive diagnostic tools, the functions viewable in the Dashboard can be used to isolate and identify many operational problems.

The acceptable ranges for these functions are listed in the “Nominal Range” column of the analyzer *Final Test and Validation Data Sheet* shipped with the instrument. Values outside these acceptable ranges Indicates a failure of one or more of the analyzer’s subsystems. Functions whose values are still within acceptable ranges but have significantly changed from the measurement recorded on the factory data sheet may also indicate a failure.

Make note of these values for reference in troubleshooting.

5.5.2. USING THE DIAGNOSTIC SIGNAL I/O FUNCTIONS

The signal I/O functions in the Utilities>Diagnostics menu allows access to the digital and analog I/O in the analyzer. Some of the digital signals can be controlled through the Setup menu. These signals are useful for troubleshooting in three ways:

- The technician can view the raw, unprocessed signal level of the analyzer’s critical inputs and outputs.
- Some components and functions that are normally under algorithmic control of the CPU can be manually exercised.
- The technician can directly control the signal level Analog and Digital Output signals.

This allows the technician to observe systematically the effect of directly controlling these signals on the operation of the analyzer. Use the Utilities>Diagnostics menu to view the raw voltage of an input signal or the Setup menu to control the state of an output voltage or control signal.

5.5.3. FAULT DIAGNOSIS WITH LEDS

The following illustrations show connectors and LEDs that can indicate where issues may lie. Figure 5-5 shows the layout for the mainboard.

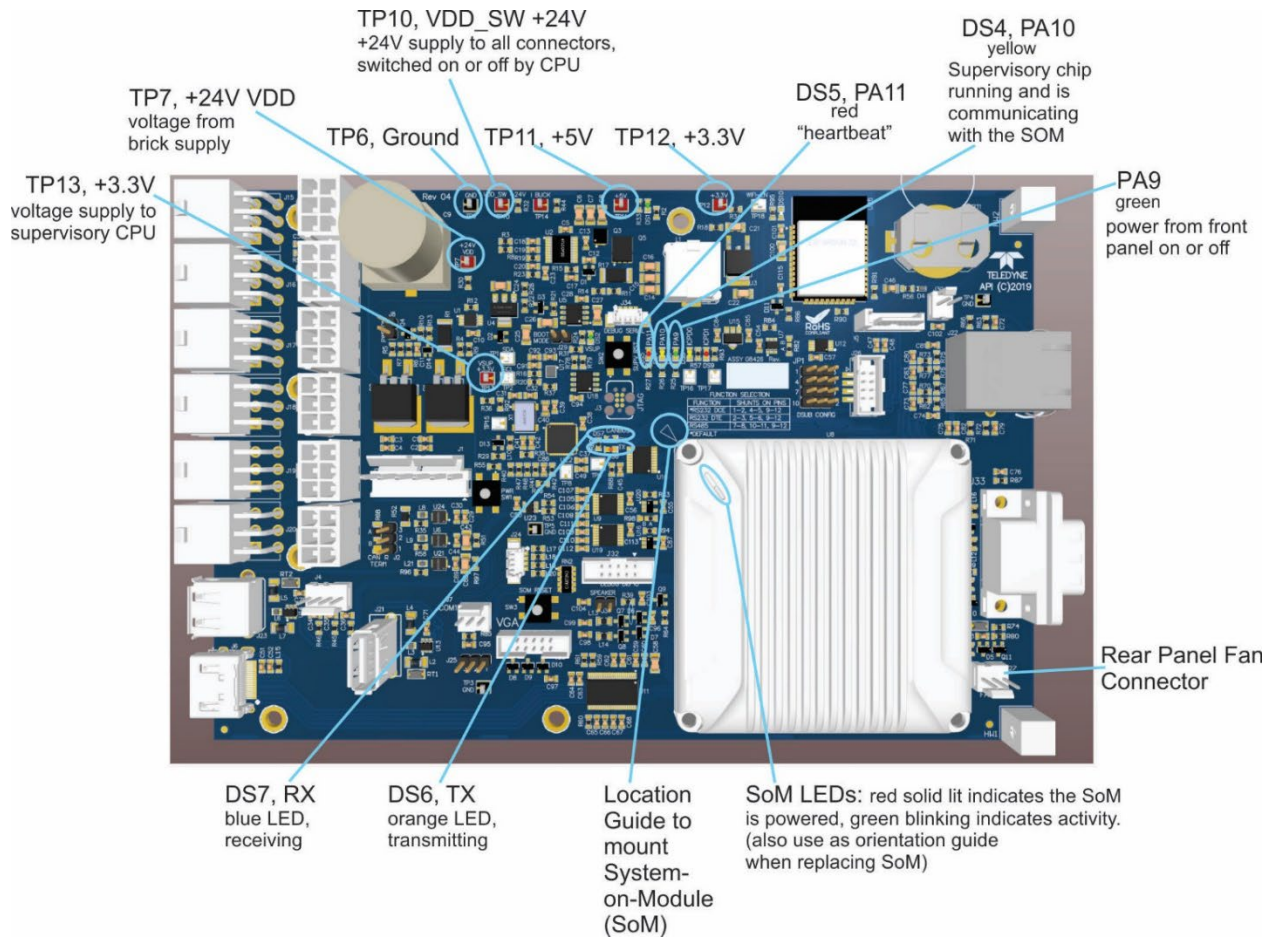

Figure 5-5. Mainboard

5.5.4. CALIBRATION PROBLEMS

This section describes possible causes of calibration problems.

5.5.4.1. ABSENCE OF ANALYZER RESPONSE TO SAMPLE GAS

If the instrument shows no response (display value is near zero) even though sample gas is supplied properly and the instrument seems to perform correctly:

1. Confirm the lack of response by supplying span gas of about 80% of the range value to the analyzer.
2. Check if pump is running at the beginning of each run, either by sound of pump or by connecting flow meter on SAMPLE IN port.
3. Check if flame is lit by placing a reflective surface such as a mirror at the FID EXHAUST port and see if the surface fogs.
4. Check for disconnected cables to the sensor module.

5.5.4.2. UNSTABLE ZERO AND SPAN

Contamination on the sample line would be the most common source of unstable and non-repeatable concentration readings.

1. Sampling lines could be contaminated; this can be remedied by “cleaning” with nitrogen (run nitrogen through the tubing); if that doesn’t work, replace the tubing.
2. If incorrect reading persists, then it could be the sample filter; in that case, contact Technical Support for guidance.
3. If calibration connections in place, consider pneumatic components in the gas delivery system outside the analyzer such as a change in zero air source (ambient air leaking into zero air line) or a change in the span gas concentration due to zero air or ambient air leaking into the span gas line.

5.5.4.3. INABILITY TO SPAN - DEACTIVATED SPAN BUTTON

In general, the analyzer will deactivate certain buttons whenever the actual value of a parameter is outside of the expected range for that parameter. If the Span is grayed out, the actual concentration must be outside of the range of the expected span gas concentration, which can have several causes.

1. Verify that the expected concentration is set properly to the actual span gas concentration in the CONC sub-menu.
2. Confirm that the span gas source is accurate.
 - This can be done by comparing the source with another calibrated analyzer.

5.5.5. OTHER POSSIBLE PERFORMANCE PROBLEMS

Dynamic problems (i.e., problems that only manifest themselves when the analyzer is monitoring sample gas) can be the most difficult and time consuming to isolate and resolve. The following section provides an itemized list of the most common dynamic problems with recommended troubleshooting checks and corrective actions.

5.5.5.1. TROUBLE IGNITING THE FLAME IONIZATION DETECTOR (FID)

After the FID flows have been adjusted (calibrated), and the instrument is fully warmed up, but the FID is still not lighting (after several unsuccessful attempts, the instrument puts itself in Standby Mode), it may be necessary to manually trigger a new attempt to ignite, by taking the instrument out of Standby Mode (set Exit Standby Mode to ON in the Homepage meter or to TRUE in the Vars).

If the individual FID flows do not reach their targets while the instrument is attempting to light the FID, verify that all gas connections on the rear of the instrument have correct pressures and that valves are open. The pressures should be set to the following psi readings:

- Carrier and Aux In cylinder regulator pressure: 70 psi
- Hydrogen cylinder regulator pressure: 50 psi
- FID Air In: 50 psi

Observe the diagnostic parameters in the Dashboard:

- The Col Temp State should be “OnSet” indicating the column has reached its setpoint. If it has not, troubleshoot the column heater. The Column temperature setpoint can be found under the VARS as “Col2 Initial Temp” (default 80 degC).
- Verify that the FID Temp is at setpoint (default 150 degC). This target can be found as “FID Temperature Set” under the VARS menu. If the FID temperature is not at the setpoint and is not climbing towards the setpoint, troubleshoot the FID heater.
- Verify that the Injector Oven Temp is at temp (default 150 degC) and that the “Inject Temp State” is “OnSet”. The VARS associated with the setpoint is “Oven Temp Setpoint.”

If the FID continues to not light following the above checks, it’s possible that the Flow requires adjustment (Section 5.5.7.1); otherwise, contact Technical Support (Section 5.6).

5.5.5.2. NEGATIVE CHROMATOGRAPH PEAKS

If a peak dips below the baseline, it is typically due to contamination of the carrier gas. To address this issue, replace the source of carrier gas, and sample again. If the dip persists, then increase the temperature of the main oven to 250 DegC by editing Setup>Vars>Oven Temp Setpoint. Maintain this temperature for four (4) hours with continuous carrier gas flow, and then return the temperature to default 150 DegC. Sample again a few more cycles. If the problem persists, contact our Technical Support Department (Section 5.6).

5.5.5.3. SLOW RESPONSE

If the analyzer starts responding too slowly to any changes in sample or span gas, check for the following:

- Dirty or plugged sample filter or sample lines.
- Sample inlet line is too long.
- Wrong materials in contact with sample - use stainless steel or Teflon materials only.
- Insufficient time for purging lines upstream of the analyzer. Wait for stability is reached.
- Insufficient time for calibration gas source to stabilize. Wait until stability is reached.
- Pump not working properly

5.5.6. SUBSYSTEM CHECK FOR TROUBLESHOOTING

The preceding sections of this manual discussed a variety of methods for identifying possible sources of failures or performance problems within the analyzer. This section describes how to determine if a certain component or subsystem is actually the cause of the problem being investigated.

5.5.6.1. AC MAIN POWER



WARNING – ELECTRICAL SHOCK HAZARD

Should the AC power circuit breaker trip, investigate and correct the condition causing this situation before turning the analyzer back on.

The instrument's electronic systems will operate with any of the specified power within the 100 VAC to 240 VAC, at 47 Hz to 63 Hz. Using the properly rated power cord, it will power on when the rear panel Hard Power switch is placed in the ON position. (If the power source is disrupted, the instrument will return to the state it was in at the time of disruption when power is restored). If the instrument doesn't start, check the following possible causes and possible solutions:

- Check the power cord for damage, such as whether it's cut or burned.
- Check that the power cord is adequately rated for the instrument's specified power rating.
- Check that the power source is of the proper voltage for the instrument's specified power rating.
- If there are no findings in the preceding steps, then note whether the instrument had been opened for maintenance; if so, place the rear panel Hard Power switch in the OFF position, and disconnect the power cord; then reopen the instrument and check that no wiring had been dislodged, and no tools were left inside.
- If no other reason can be found for the instrument not powering on, then check the fuse with an ohmmeter to determine its viability: carefully follow the instructions in Section 5.5.7.1 to remove the fuse for testing.
 - If the fuse is blown, replace it with a fuse of the correct specifications as instructed in Section 5.5.7.1.
- If the fuse is not blown, or if the replacement fuse blows, then call Technical Support (Section 5.6).

5.5.6.2. LCD/DISPLAY MODULE

Assuming that there are no wiring problems and that the DC power supplies are operating properly, the display screen should light and show the splash screen and other indications of its state as the CPU goes through its initialization process.

5.5.6.3. RS-232 COMMUNICATIONS

Teledyne API's analyzers use the RS-232 communications protocol to allow the instrument to be connected to a variety of computer-based equipment. Problems with RS-232 connections usually center around such things as incorrect connector configuration, incorrect software settings, improper/incomplete seating of the internal cable. Do not do anything inside the instrument without first contacting Technical Support (Section 5.6). For additional information, see Section 2.3.1.4 under "Serial Connection."

5.5.7. SERVICE PROCEDURES

This section contains some procedures that may need to be performed when a major component of the analyzer requires repair or replacement.

Note

Regular maintenance procedures are discussed in Section 5.4 and are not listed here). Also, there may be more detailed service notes for some of the below procedures. Contact Teledyne API's Technical Support Department (Section 5.6).

**WARNING – ELECTRICAL SHOCK HAZARD**

Unless the procedure being performed requires the instrument to be operating, turn it off and disconnect power before opening the analyzer and removing, adjusting or repairing any of its components or subsystems.

**CAUTION – QUALIFIED TECHNICIAN**

The operations outlined in this chapter are to be performed by qualified maintenance personnel only.

5.5.7.1. FLOW ADJUSTMENT (CALIBRATION) PROCEDURES

Flow can be adjusted (calibrated) to ensure that the FID is easy to light and has an optimized flame. Environmental conditions such as elevation, barometric pressure, etc., may influence the ignition and optimization of the flame causing the need to adjust some or all flows. Any time a unit has trouble igniting, follow these procedures:

1. Ensure the instrument is fully warmed up, and FID, Injector Oven, and Column temperatures are at their preprogrammed set points/factory flow targets (per documentation delivered with the instrument).
2. Place the instrument in Standby mode (set Enter Standby Control to ON in Homepage meter or to TRUE in Vars).
3. Connect a flow meter suitable for the target flow range to the FID exhaust. A rotameter should be sufficient.
4. Make sure all support gases (Air, Aux, Carrier, Sample) are connected to their respective N901 rear panel ports. Make sure all external valves are open, and regulators are set to correct pressures.
5. Navigate to Calibration Utilities>Diagnostics> Flow Adjust and press the “Start” button to begin the FID flow calibration.

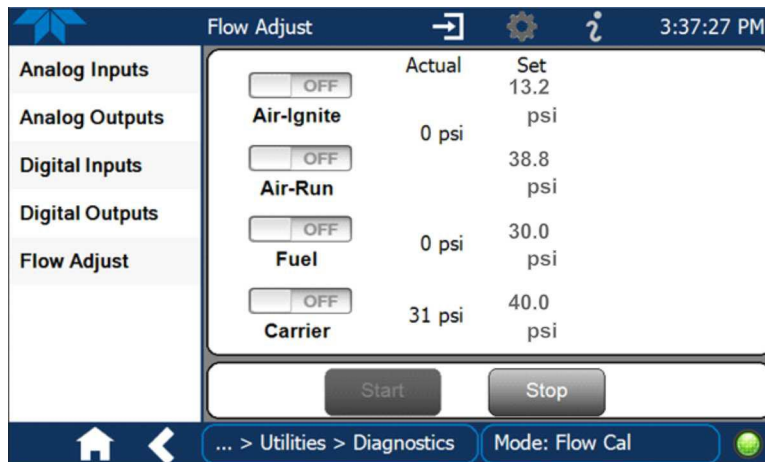

Figure 5-6. Flow Adjust Menu

6. Allow the carrier gas to stabilize at 3 PSI.
7. Starting with the Air-Ignite flow, slide the switch to “ON”, and measure the output flow at the FID. Use the << or >> buttons to decrease/increase flow, and press “Set” to set the pressure. Repeat the flow adjustments until the output flow matches the factory flow target. When the pressure is correct, slide the switch to “OFF” and repeat this step for the remaining flows, Air-Run, Fuel, and Carrier.
8. Once all four flows are set, press the “Stop” button.
9. Return to Home screen and exit Standby mode (set Exit Standby Control to ON in the Homepage meter or navigate to Setup>Vars>Exit Standby Control and set to TRUE.

The FID should light within several minutes. If not, follow the instructions in Section 5.5.5.1.

5.5.7.2. COLUMN MAINTENANCE

A column’s lifetime depends on its environment and its frequency and duration of operation. Because the software periodically initiates a regular bakeout where the temperature is increased and maintained long enough to remove any buildup of residuals, the column typically requires no additional service. This cleanout takes place every 6 hours; it starts at 80 °C for 25 sec, ramps up by 3 °C/sec to 285 °C, maintained for 30 sec, then drops to 80 °C.

However, the bakeout can be manually performed if there is an unexpected change in a column phase. Such changes could be tailing peaks, fronting peaks, or shift in retention time. In the case of hardware, the temperature reading may be either faulty or out of control. To initiate a manual bakeout, change the Setup>Vars>Enter Bakeout Control to True. If the analyzer is in the process of measuring, it will finish taking the measurement, and then the bakeout will begin and end automatically, and the “Enter Bakeout Control” Var will default back to False on its own.

For hardware failure or other persistent poor performance, contact Technical Support (Section 5.6) for instructions on removing and shipping the column to TAPI to be refurbished, and to install a replacement column in the meantime.

5.5.7.3. FILTER ELEMENT REPLACEMENT

To remove and replace the element inside the SS filter assembly:

1. Place the instrument in Standby mode (set “Enter Standby Control” either to ON in Homepage meter or to TRUE in Vars) so that no gases are moving and the pump is off.
1. Disconnect tubing from filter.
2. Remove used filter from bracket.
3. Install the new filter in bracket, adhering to orientation arrow.
4. Reattach tubing from SAMPLE IN port to new filter.
5. Restart sampling.

5.5.7.4. PUMP REPLACEMENT

The pump typically lasts about one year with regular use, but because the N901 uses the pump for only seconds at a time, it is expected to last longer. Two ways to know whether the pump has failed are if:

- There is no audible sound when the pump should be running at the beginning of each measurement run.
- During HC sampling, the measurement shows 0 and the chromatogram on the SPAN CAL menu shows a flat line/no peaks.

In either case, look for pump failure. Call Technical Support for replacement instructions.

5.5.7.5. FUSE REPLACEMENT PROCEDURE

ATTENTION

COULD DAMAGE INSTRUMENT AND VOID WARRANTY

Fuses do not typically fail without definite cause. Do not attempt to replace until after all measures to detect the cause of a power failure, per Section 5.5.6.1, have been carried out, including Soft Power switch LED not lit (neither solid nor blinking), but Hard Power switch is in ON position and instrument's power cord properly connected at both ends. If an ohmmeter shows that the fuse is good, or if a new fuse blows, call Technical Support (Section 5.6).

WARNING – ELECTRICAL SHOCK HAZARD



Never pull out fuse drawer without ensuring that the Hard Power switch is in OFF position and power cord disconnected, to ensure there is no power to the instrument before checking/changing fuse.

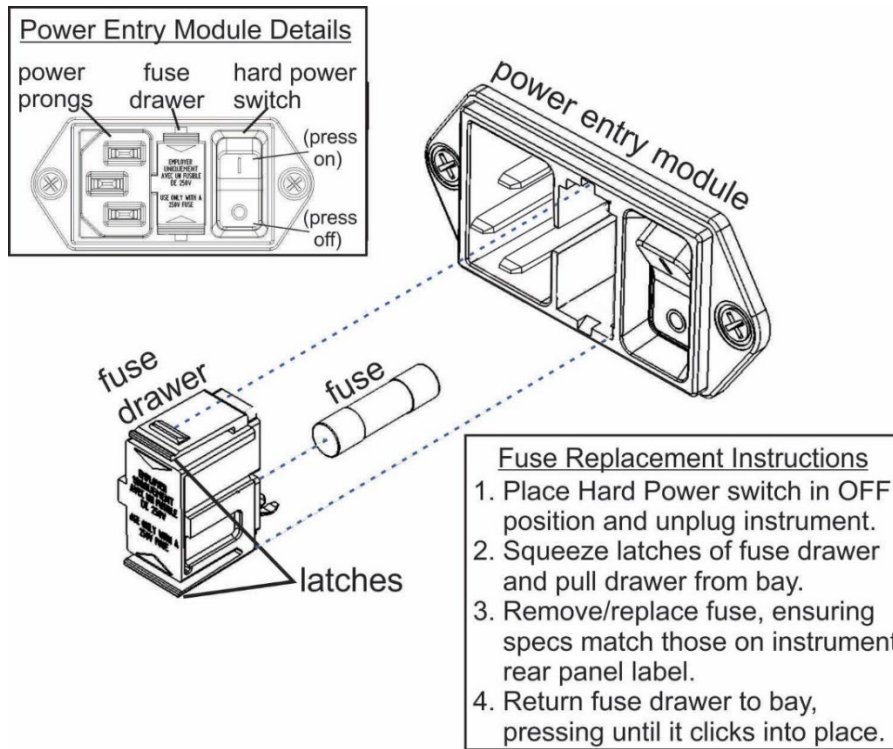

Figure 5-7. Fuse Access

5.6. TECHNICAL ASSISTANCE

For spare parts, or if this manual and its troubleshooting & service section do not solve your problems, technical assistance may be obtained from:

Teledyne API Technical Support
9970 Carroll Canyon Road
San Diego, California 92131-1106 USA

Toll-free Phone: +1 800-324-5190

Phone: +1 858-657-9800

Fax: +1 858-657-9816

Email: api-techsupport@teledyne.com

Website: <http://www.teledyne-api.com/>

6. PRINCIPLES OF OPERATION

The N901 performs Hydrocarbon (HC) analysis by means of Gas Chromatography (GC) with Flame Ionization Detection (FID), using a preparative method of automatic injection, separation, and fraction collection. GC in the N901 employs a carrier gas (an inert gas that does not get measured), of 99.999% or UHP-grade Nitrogen (N_2) to move the sample gas into the FID for analysis. The FID produces a small flame ignited upon injection of fuel (hydrogen, H_2) and oxygen (O_2) at initial startup to combust the organic compounds of the sample gas, producing ions that generate a proportionate current, which is then recorded as Total Hydrocarbons (THC). The flame remains lit until the instrument is either placed in Standby mode or powered off.

The sample gas also passes through the GC column that separates the lighter-weight methane (CH_4) from the heavier-weight HCs so that only the CH_4 continues its transport by the carrier gas to the FID for measurement and recording.

Each measuring cycle then produces a chromatogram (Figure 6-1) consisting of three distinguishable peaks: THC, Oxygen (O_2), and CH_4 . The instrument's internal software uses the chromatogram results to calculate the THC and CH_4 concentrations using a combination of peak height and peak area integration, while also accurately measuring and removing the O_2 (peak) artifact.

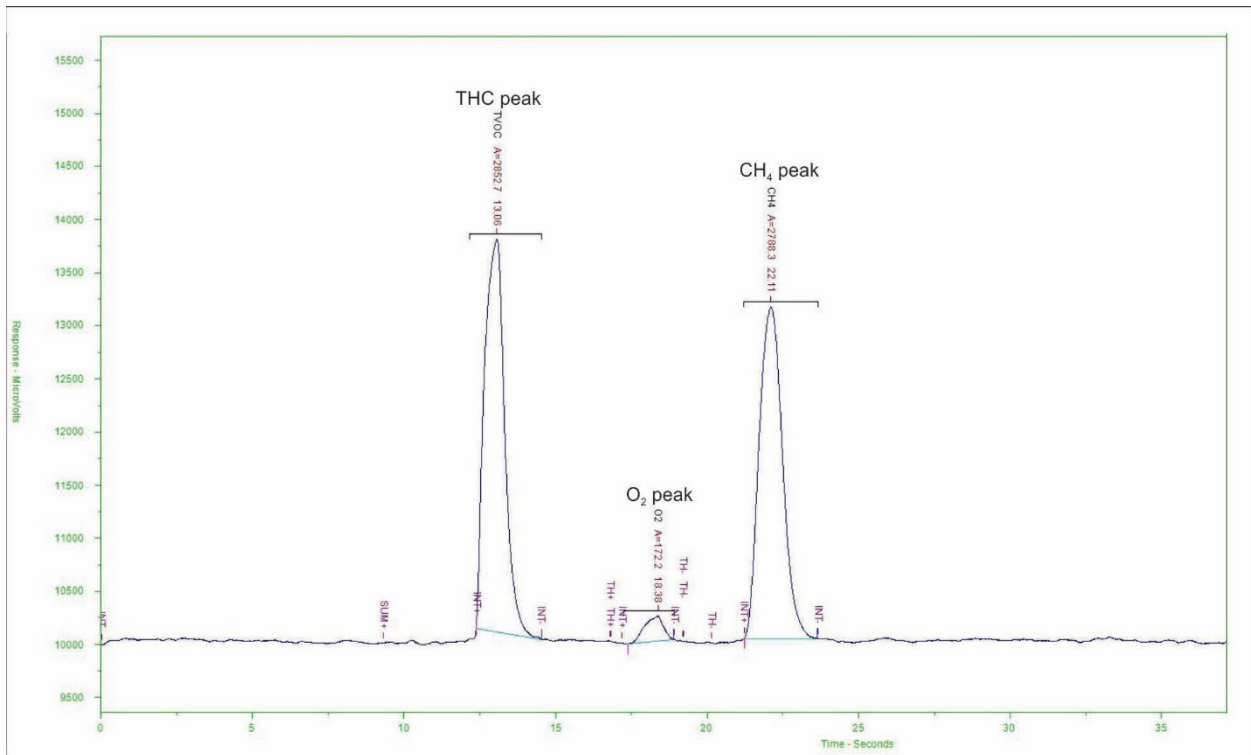

Figure 6-1. Chromatogram Example of THC, O_2 , and CH_4 Peaks

6.1. PNEUMATIC OPERATION

During the Sample Capture phase (refer to the pneumatic diagram, Figure 2-9), an internal DC pump pulls ambient air through an external sample filter connected to the Sample In port, and into the sample path that includes two loops into which the sample gas enters by way of a 10-port switch valve.

At the same time, a pressure-regulated carrier gas enters the instrument via the Carrier In port, passes through its own internal pressure regulator, and exits through the FID until the switch valve switches ports, starting the Measure phase (refer to the pneumatic diagram, Figure 2-10); this switch of ports directs the carrier gas into both loops by way of a tee-fitting. The carrier gas then carries the sample gas from the first loop directly into the FID and out the FID exhaust, and simultaneously carries the sample gas from the second loop through a molecular sieve column for separation between lighter and heavier compounds before continuing into the FID and out the FID exhaust.

Pressure-regulated zero air enters the Air In port while pressure-regulated high purity hydrogen enters the Fuel port; both the air and the fuel pass through their respective internal pressure regulators and into the FID where they ignite the ionizing flame.

Gas and air exit the instrument through either the FID Exhaust or the Sample Exhaust ports.

6.2. ELECTRONIC OPERATION

The electronic platform is based on a Controller Area Network (CAN) bus modular system. CAN is the central networking system that enables communication among all the parts and facilitates centralized diagnoses of errors, as well as configuration of all the parts. CAN bus technology allows for a uniform cable architecture with interchangeable 6-pin connectors configured for power (5 V and 24 V) and communications (CAN high and CAN low serial lines).

The Mainboard is the main hub, which not only contains the Central Processing Unit (CPU) that communicates with other modules, but also directs power and communication distribution. The Mainboard includes an altitude sensor, a temperature sensor, and the Supervisory Chip.

The Supervisory Chip monitors power and the sensors, and when the front panel Soft Power switch is pressed (see Power Switches, Section 6.2.2), the Supervisory Chip directs the soft power down of the internal components, to safely shut down processes and close connections to prevent damage.

6.2.1. MODULES

Each module consists of its own board controlled by a microprocessor that receives messages from and sends information to the Mainboard on the CAN network. Depending on the signal line, CAN Low or CAN High, the modules can determine whether a message is intended for them and what the priority is, and then act on the applicable messages. These are called “Smart Modules,” which conduct local operations, such as activating valves or controlling manifold temperature. There is also the Sensor Module, which is comprised of the gas sensor and its operational components. The Sensor Module calculates gas concentrations and may command the Smart Modules.

6.2.2. POWER SWITCHES

The front panel Soft Power switch is used to protect the internal components from damage. When the instrument is initially powered on, the Supervisory Chip spins up the internal computer components and places them in operational mode (indicated by LED's solid-lit state). However, before powering off the instrument, pressing and momentarily holding the solid-lit Soft Power switch tells the Supervisory Chip to put the internal computer components through a soft-shutdown process and into deep sleep mode (indicated by LED's blinking state).

The rear panel Hard Power switch is used to turn on or off the instrument, but should not be used to turn off the instrument until first placing it in deep sleep mode as described above. If there is an unexpected loss of source power while the instrument is running, it will power up in the ON state when source power is restored.

APPENDIX A – MODBUS REGISTERS

ADDR	NAME	DESCRIPTION
Discrete Inputs		
0	Sys_Warn_Reset	Indicates status of system reset warning
1	Carrier_Pressure_Warning	indicates status of carrier pressure warning
2	Col_Temp_Warning	Indicates status of column temperature warning
3	FID_Flameout_Warning	Indicates status of flame ionization detector flameout warning
4	GC_Data_Warning	Indicates status of gas chromatograph data warning
5	Ignition_Failure_Warning	Indicates status of ignition failure warning
6	Measure_Aborted_Warning	Indicates status of measure aborted warning
7	Sys_Warn_Digital_IO_Com_Warning	Indicates status of digital I/O board communication warning
8	Sys_Warn_Supervisor_Com_Warning	Indicates status of supervisory communication warning
9	ASF_Bakeout_Mode_Active	Indicates instrument is actively in bakeout mode
10	Samp_Loop-Vlv_Stat	Indicates status of sample loop valve
11	Switch_Vlv_Stat	Indicates status of switch valve
12	ASF_Span_Cal_Actve	Indicates instrument is performing Span Cal
13	ASF_Span_Cal_R_Actve	Indicates instrument is performing Remote Span Cal
14	ASF_Span_Cal_A_Actve	Indicates instrument is actively performing Auto Span Cal
Coils		
0	MB_Span_Cal_Range_1	Control span calibration of Range 1
1	Control_Exit_Stby	Exit standby control
2	Control_Enter_Stby	Enter standby control
3	Control_Bakeout_Enter	Enter bakeout control
4	Cont_Export_Enable	Enable export of data results
Input Registers		
0	CH4_Conc	CH4 concentration value in PPB
2	CH4_Retention_Time	CH4 retention time
4	CH4_Baseline_Begin_Time	Establishes baseline for CH4
6	CH4_Peak_Start_Det	Sets start of window for detecting CH4
8	CH4_Peak_Stop_Det	Sets end of window for detecting CH4
10	THC_Conc	THC concentration value in PPB
12	THC_Retention_Time	THC retention time
14	THC_Baseline_Begin_Time	Establishes baseline for THC
16	THC_Peak_Start_Det	Sets start of window for detecting THC
18	THC_Peak_Stop_Det	Sets end of window for detecting THC
20	NMHC_Conc	NMHC concentration value in PPB
22	Col2_Temp	Column temperature degC
24	Det2_Temp	Detector temperature degC
26	RT_FID_Output_D	Output from electronic board
28	AI_Box_Temp	Box temperature degC

30	Flow_Percent	Flow PCT
32	FID_Data_Count	FID data count
34	Injector_Runs	injector total runs
36	O2_Integ_Sum	O2 integ sum
38	Switch_Cycles	Switch valve total cycles
40	THC_Avg_Area	THC average area
42	THC_Integ_Sum	THC integrated sum
44	Run_Time_Rem	Runtime remaining
46	Air_Det2_Press	Detector 2 Air Pressure (PSI)
48	H2_Det2_Press	Detector 2 Hydrogen Pressure (PSI)
50	Carr_Gas_Press	Carrier Gas Pressure (PSI)
52	Injector_Temp	Injector Oven Temp degC
54	Det2_AZero_PWM	Detector 2 Auto Zero PWM
Holding Registers		
0	Injector_Oven_Temp	Injector oven temperature setpoint degC
2	Det2_Air_Run_Press	Detector air-run gas pressure setpoint (PSI)
4	Det2_Air_Ignite_Press	Detector air-ignite gas pressure setpoint (PSI)
6	Det2_H2_Press	Detector H2 gas pressure setpoint (PSI)
8	Carr_Initial_Press	Carrier gas pressure setpoint (PSI)
10	Det2_Flame_Lit_Thresh	Detector flame threshold setpoint
12	DC_Pump_Fill_Time	DC pump fill time setpoint
14	CH4_Target_Span_Conc	CH4 target span concentration in PPB
16	NMHC_Target_Span_Conc	NMHC target span concentration in PPB
18	NMHC_Carbon_Count	NMHC carbon count