



**User Manual**

***Model T753U***

***Portable Trace-Level O<sub>3</sub> Calibrator***

*with NumaView™ Software*

© TELEDYNE API (TAPI)  
9970 CARROLL CANYON ROAD  
SAN DIEGO, CALIFORNIA 92131-1106  
USA

Toll-free Phone: 800-324-5190  
Phone: 858-657-9800  
Fax: 858-657-9816  
Email: [api-sales@teledyne.com](mailto:api-sales@teledyne.com)  
Website: <http://www.teledyne-api.com/>



## **NOTICE OF COPYRIGHT**

© 2018-2023 Teledyne API (TAPI). All rights reserved.

## **TRADEMARKS**

All trademarks, registered trademarks, brand names or product names appearing in this document are the property of their respective owners and are used herein for identification purposes only.

## SAFETY MESSAGES

Important safety messages are provided throughout this manual for the purpose of avoiding personal injury or instrument damage. Please read these messages carefully. Each safety message is associated with a safety alert symbol, and placed throughout this manual and inside the instrument. The symbols with messages are defined as follows:



**WARNING:** Electrical Shock Hazard



**HAZARD:** Strong oxidizer



**GENERAL WARNING/CAUTION:** Read the accompanying message for specific information.



**CAUTION:** Hot Surface Warning



**Do Not Touch:** Touching some parts of the instrument without protection or proper tools could result in damage to the part(s) and/or the instrument.



**Technician Symbol:** All operations marked with this symbol are to be performed by qualified maintenance personnel only.



**Electrical Ground:** This symbol inside the instrument marks the central safety grounding point for the instrument.

### CAUTION

This product should only be installed, commissioned, and used strictly for the purpose and in the manner described in this manual. If you improperly install, commission, or use this instrument in any manner other than as instructed in this manual or by our Technical Support team, unpredictable behavior could ensue with possible hazardous consequences.

Such risks, whether during installation and commission or caused by improper installation/commissioning/use, and their possible hazardous outcomes include but are not limited to:



| RISK                                                    | HAZARD                          |
|---------------------------------------------------------|---------------------------------|
| Liquid or dust/debris ingress                           | Electrical shock hazard         |
| Improper or worn power cable                            | Electrical shock or fire hazard |
| Excessive pressure from improper gas bottle connections | Explosion and projectile hazard |
| Sampling combustible gas(es)                            | Explosion and fire hazard       |
| Improper lift & carry techniques                        | Personal injury                 |

Note that the safety of a system that may incorporate this product is the end user's responsibility.

**Technical Assistance regarding the use and maintenance of this instrument or any other Teledyne API product is available by contacting Teledyne API's Technical Support Department:**

**Telephone: 800-324-5190**

**Email: [sda\\_techsupport@teledyne.com](mailto:sda_techsupport@teledyne.com)**

**or by accessing various service options on our website at <http://www.teledyne-api.com/>**

## CONSIGNES DE SÉCURITÉ

Des consignes de sécurité importantes sont fournies tout au long du présent manuel dans le but d'éviter des blessures corporelles ou d'endommager les instruments. Veuillez lire attentivement ces consignes. Chaque consigne de sécurité est représentée par un pictogramme d'alerte de sécurité; ces pictogrammes se retrouvent dans ce manuel et à l'intérieur des instruments. Les symboles correspondent aux consignes suivantes :



**AVERTISSEMENT** : Risque de choc électrique



**DANGER** : Oxydant puissant



**AVERTISSEMENT GÉNÉRAL / MISE EN GARDE** : Lire la consigne complémentaire pour des renseignements spécifiques



**MISE EN GARDE** : Surface chaude



**Ne pas toucher** : Toucher à certaines parties de l'instrument sans protection ou sans les outils appropriés pourrait entraîner des dommages aux pièces ou à l'instrument.



**Pictogramme « technicien »** : Toutes les opérations portant ce symbole doivent être effectuées uniquement par du personnel de maintenance qualifié.



**Mise à la terre** : Ce symbole à l'intérieur de l'instrument détermine le point central de la mise à la terre sécuritaire de l'instrument.

## MISE EN GARDE

Ce produit ne doit être installé, mis en service et utilisé qu'aux fins et de la manière décrites dans le présent manuel. Si vous installez, mettez en service ou utilisez cet instrument de manière incorrecte autre que celle indiquée dans ce manuel ou sous la direction de notre équipe de soutien technique, un comportement imprévisible pourrait entraîner des conséquences potentiellement dangereuses.

Ce qui suit est une liste, non exhaustive, des risques et résultats dangereux possibles associés avec une mauvaise utilisation, une mise en service incorrecte, ou causés mauvaise commission.



| RISQUE                                                                   | DANGER                                         |
|--------------------------------------------------------------------------|------------------------------------------------|
| Pénétration de liquide ou de poussière/débris                            | Risque de choc électrique                      |
| Câble d'alimentation incorrect, endommagés ou usé                        | Choc électrique ou risque d'incendie           |
| Pression excessive due à des connexions de bouteilles de gaz incorrectes | Risque d'explosion et d'émission de projectile |
| Échantillonnage de gaz combustibles                                      | Risque d'explosion et d'incendie               |
| Techniques de manutention, soulèvement et de transport inappropriées     | Blessure corporelle                            |

Notez que la sécurité d'un système qui peut incorporer ce produit est la responsabilité de l'utilisateur final.

## WARRANTY

### WARRANTY POLICY (02024J)

Teledyne API (TAPI), a business unit of Teledyne Instruments, Inc., provides that:

Prior to shipment, TAPI equipment is thoroughly inspected and tested. Should equipment failure occur, TAPI assures its customers that prompt service and support will be available. (For the instrument-specific warranty period, please refer to the “Limited Warranty” section in the Terms and Conditions of Sale on our website at [www.teledyne-api.com](http://www.teledyne-api.com)).

### COVERAGE

After the warranty period and throughout the equipment lifetime, TAPI stands ready to provide on-site or in-plant service at reasonable rates similar to those of other manufacturers in the industry. All maintenance and the first level of field troubleshooting are to be performed by the customer.

### NON-TAPI MANUFACTURED EQUIPMENT

Equipment provided but not manufactured by TAPI is warranted and will be repaired to the extent and according to the current terms and conditions of the respective equipment manufacturer’s warranty.

### PRODUCT RETURN

All units or components returned to Teledyne API should be properly packed for handling and returned freight prepaid to the nearest designated Service Center. After the repair, the equipment will be returned, freight prepaid.

The complete Terms and Conditions of Sale can be reviewed on our website.



#### CAUTION – Avoid Warranty Invalidation

Failure to comply with proper anti-Electro-Static Discharge (ESD) handling and packing instructions and Return Merchandise Authorization (RMA) procedures when returning parts for repair or calibration may void your warranty. For anti-ESD handling and packing instructions please refer to the manual, Fundamentals of ESD, PN 04786, in its “Packing Components for Return to Teledyne API’s Customer Service” section. The manual can be downloaded from our website at <http://www.teledyne-api.com>. RMA procedures can also be downloaded from our website.



# TABLE OF CONTENTS

|                                                              |           |
|--------------------------------------------------------------|-----------|
| <b>1. INTRODUCTION</b>                                       | <b>15</b> |
| 1.1. Options                                                 | 16        |
| 1.2. Specifications                                          | 17        |
| 1.3. Compliance and Certifications                           | 18        |
| <b>2. GETTING STARTED</b>                                    | <b>19</b> |
| 2.1. Unpacking                                               | 19        |
| 2.2. Instrument Layout                                       | 20        |
| 2.2.1. Input and Control Panel                               | 20        |
| 2.2.2. Communications and Output Panel                       | 21        |
| 2.2.3. Internal Layout                                       | 22        |
| 2.3. Connections and Startup                                 | 24        |
| 2.3.1. Electrical Connections                                | 24        |
| 2.3.1.1. Power Connection                                    | 24        |
| 2.3.1.2. Connecting the Analog Output Channel                | 25        |
| 2.3.1.3. Connecting the Status Outputs (Digital Outputs)     | 25        |
| 2.3.1.4. Connecting the Control Inputs (Digital Inputs)      | 26        |
| 2.3.1.5. Connecting the Control Outputs (Digital Outputs)    | 28        |
| 2.3.1.6. Connecting the Communication Interfaces             | 29        |
| 2.3.2. Pneumatic Connections                                 | 34        |
| 2.3.2.1. Dry Air In                                          | 34        |
| 2.3.2.2. Zero Air In                                         | 35        |
| 2.3.2.3. Cal Gas Out                                         | 35        |
| 2.3.2.4. Exhaust                                             | 35        |
| 2.4. Initial Startup                                         | 36        |
| 2.4.1. Alerts: Warnings and Other Messages                   | 37        |
| 2.4.2. Functional Checks                                     | 37        |
| 2.4.3. Start Generating                                      | 38        |
| <b>3. CONFIGURATION</b>                                      | <b>39</b> |
| 3.1. Menu Overview                                           | 39        |
| 3.2. Main Menu Pages                                         | 41        |
| 3.2.1. Home                                                  | 41        |
| 3.2.2. Dashboard                                             | 42        |
| 3.2.3. Alerts                                                | 43        |
| 3.2.4. Generate                                              | 44        |
| 3.2.5. Utilities                                             | 45        |
| 3.2.5.1. Datalog View                                        | 45        |
| 3.2.5.2. Alerts Log                                          | 45        |
| 3.2.5.3. USB Utilities (Downloads and Updates)               | 45        |
| 3.2.5.4. Diagnostics                                         | 47        |
| 3.3. Setup (Configuring the Calibrator's Features/Functions) | 48        |
| 3.3.1. Setup>Data Logging                                    | 48        |
| 3.3.1.1. Creating a User-Defined Data Log                    | 49        |
| 3.3.1.2. Configuring Trigger Types for the Datalogger        | 50        |
| 3.3.2. Setup>Events                                          | 51        |
| 3.3.2.1. Creating User-defined Events                        | 52        |
| 3.3.2.2. Editing or Deleting Events                          | 52        |
| 3.3.3. Setup>Dashboard                                       | 53        |
| 3.3.4. Setup>Vars (Variables)                                | 54        |
| 3.3.5. Setup>Homescreen                                      | 54        |
| 3.3.6. Setup>Digital Outputs (Status)                        | 55        |
| 3.3.7. Setup>Sequences                                       | 55        |
| 3.3.7.1. Editing/Deleting Sequences                          | 58        |
| 3.3.7.2. Activating Sequences                                | 58        |
| 3.3.8. Setup>Levels                                          | 58        |

|                                                                               |           |
|-------------------------------------------------------------------------------|-----------|
| 3.3.8.1. Editing/Deleting Levels .....                                        | 59        |
| 3.3.8.2. Activating Levels .....                                              | 59        |
| 3.3.9. Setup>Analog Outputs .....                                             | 60        |
| 3.3.9.1. Analog Output Voltage Range Configuration.....                       | 61        |
| 3.3.9.2. Adding a Recorder Offset to the Analog Output .....                  | 61        |
| 3.3.9.3. Calibrating the Analog Output.....                                   | 61        |
| 3.3.10. Setup>Instrument.....                                                 | 63        |
| 3.3.10.1. Instrument Date/Time Adjustments .....                              | 64        |
| 3.3.11. Setup>Comm (Communications).....                                      | 65        |
| 3.3.11.1. COM1/COM2 .....                                                     | 65        |
| 3.3.11.2. TCP Port1 .....                                                     | 66        |
| 3.3.11.3. TCP Port2 .....                                                     | 66        |
| 3.3.11.4. Network Settings.....                                               | 66        |
| <b>4. OPERATION</b>                                                           | <b>69</b> |
| 4.1. Automatic Operation Using Sequences .....                                | 69        |
| 4.1.1. Activating a Sequence from the Touchscreen .....                       | 70        |
| 4.1.2. Activating a Sequence with the Internal Timer.....                     | 70        |
| 4.1.3. Activating a Sequence with the External Digital Control Inputs .....   | 70        |
| 4.1.4. Activating a Sequence or Defaulting to Control Other Devices .....     | 70        |
| 4.1.5. Activating a Sequence through a Communications Interface .....         | 70        |
| 4.1.6. Activating a Sequence as a Subprocess in another Sequence .....        | 71        |
| 4.2. Automatic Operation Using LEADS Levels .....                             | 71        |
| 4.2.1.1. Activating Levels .....                                              | 71        |
| 4.3. Operating the Calibrator as an O <sub>3</sub> Photometer .....           | 72        |
| 4.3.1. Set up for Operation as an O <sub>3</sub> Photometer .....             | 72        |
| 4.4. Resetting the Output Flow Rate .....                                     | 73        |
| 4.4.1. Calculating Output Flow Rate.....                                      | 74        |
| 4.4.2. Output Flow Reset Procedure .....                                      | 74        |
| <b>5. COMMUNICATIONS FOR REMOTE OPERATION.....</b>                            | <b>75</b> |
| 5.1. Using the Communication Ports.....                                       | 75        |
| 5.2. Data Terminal / Communication Equipment (DTE DCE) .....                  | 75        |
| 5.3. Modes, Baud Rate and Serial Communication .....                          | 75        |
| 5.3.1. Serial Communication: RS-232.....                                      | 75        |
| 5.3.2. Serial Communication: RS-485 (Option).....                             | 76        |
| 5.4. Ethernet .....                                                           | 76        |
| 5.5. MODBUS Protocol.....                                                     | 76        |
| 5.5.1.1. MODBUS Com Port Configuration.....                                   | 77        |
| <b>6. CALIBRATION AND VERIFICATION.....</b>                                   | <b>79</b> |
| 6.1. Verifying/Calibrating the O <sub>3</sub> Photometer .....                | 79        |
| 6.1.1. Setup for Verifying and Calibrating the O <sub>3</sub> Photometer..... | 79        |
| 6.1.1.1. Calibration Manifold Exhaust/Vent Line .....                         | 80        |
| 6.1.2. Verifying O <sub>3</sub> Photometer Performance .....                  | 80        |
| 6.1.3. Calibrating the O <sub>3</sub> Photometer.....                         | 81        |
| 6.1.3.1. Photometer Zero Calibration.....                                     | 81        |
| 6.1.3.2. Photometer Span Calibration.....                                     | 81        |
| 6.1.4. O <sub>3</sub> Photometer Backpressure Compensation Calibration .....  | 82        |
| 6.2. Calibrating the O <sub>3</sub> Generator .....                           | 83        |
| 6.3. Calibrating Gas Pressure Sensors .....                                   | 83        |
| 6.3.1. Gas Pressure Sensor Calibration Set Up.....                            | 83        |
| 6.3.2. Calibrating the Pressure Sensors .....                                 | 85        |
| 6.4. Gas Flow Calibration .....                                               | 86        |
| 6.4.1. Calibrating the Photometer's Sample Gas Flow .....                     | 88        |
| 6.4.2. Calibrating the Output Gas Flow .....                                  | 89        |
| 6.5. Analog Input (AIN) Calibration.....                                      | 89        |
| <b>7. MAINTENANCE AND SERVICE .....</b>                                       | <b>91</b> |

|                                                                                                 |            |
|-------------------------------------------------------------------------------------------------|------------|
| 7.1. Maintenance Schedule .....                                                                 | 91         |
| 7.2. Operational Health Checks.....                                                             | 95         |
| 7.3. Software/Firmware Updates .....                                                            | 95         |
| 7.3.1. Remote Updates .....                                                                     | 95         |
| 7.3.2. Manual Reload/Update Procedures .....                                                    | 96         |
| 7.4. Performing Leak Checks .....                                                               | 97         |
| 7.5. Cleaning or Replacing the Absorption Tube.....                                             | 99         |
| 7.6. Assessing Usage of and Replacing Desiccant (Silica Gel) .....                              | 100        |
| 7.7. Adjusting the Photometer UV Source Lamp.....                                               | 102        |
| 7.8. Replacing the Photometer UV Source Lamp .....                                              | 103        |
| 7.9. Adjusting or Replacing the Ozone Generator UV Lamp .....                                   | 104        |
| <b>8. GENERAL TROUBLESHOOTING &amp; SERVICE .....</b>                                           | <b>105</b> |
| 8.1. General Troubleshooting .....                                                              | 105        |
| 8.1.1. Fault Diagnosis with Messages in the Alerts Page .....                                   | 106        |
| 8.1.2. Fault Diagnosis With Dashboard Functions .....                                           | 107        |
| 8.1.3. Using the Diagnostic Analog Inputs Function .....                                        | 108        |
| 8.2. Using the Signal Outputs for Diagnostics.....                                              | 109        |
| 8.3. Using the Internal Electronic Status LEDs .....                                            | 110        |
| 8.3.1. CPU Status Indicator .....                                                               | 110        |
| 8.3.2. Power Distribution Board Status LEDs .....                                               | 110        |
| 8.3.2.1. I <sup>2</sup> C Bus Watchdog Status LEDs.....                                         | 111        |
| 8.3.2.2. Troubleshooting with Power Distribution Board Status LEDs.....                         | 111        |
| 8.4. Subsystem Checkout.....                                                                    | 113        |
| 8.4.1. Verify Subsystem Calibration .....                                                       | 113        |
| 8.4.2. AC Main Power .....                                                                      | 113        |
| 8.4.3. DC Power Supply .....                                                                    | 113        |
| 8.4.4. I <sup>2</sup> C Bus .....                                                               | 115        |
| 8.4.5. Touchscreen Interface.....                                                               | 115        |
| 8.4.6. Power Distribution Board.....                                                            | 116        |
| 8.4.7. Photometer O <sub>3</sub> Generator Pressure /Flow Sensor Assembly .....                 | 116        |
| 8.4.8. Motherboard .....                                                                        | 118        |
| 8.4.8.1. A/D Functions.....                                                                     | 118        |
| 8.4.8.2. Test Channel / Analog Outputs Voltage .....                                            | 118        |
| 8.4.8.3. Status Outputs (Digital Output Pins 1 – 8).....                                        | 119        |
| 8.4.8.4. Digital Control Inputs.....                                                            | 119        |
| 8.4.8.5. Control Outputs (Digital Output Pins 1 – 12) .....                                     | 120        |
| 8.4.9. CPU .....                                                                                | 121        |
| 8.4.10. RS-232 Communications .....                                                             | 121        |
| 8.4.10.1. General RS-232 Troubleshooting .....                                                  | 121        |
| 8.4.11. Temperature Problems.....                                                               | 121        |
| 8.4.11.1. Box / Chassis Temperature .....                                                       | 121        |
| 8.4.11.2. Photometer Sample Chamber Temperature.....                                            | 121        |
| 8.4.11.3. UV Lamp Temperature .....                                                             | 122        |
| 8.4.11.4. Ozone Generator Temperature.....                                                      | 122        |
| 8.5. Troubleshooting the O <sub>3</sub> Photometer .....                                        | 123        |
| 8.5.1. Dynamic Problems with the O <sub>3</sub> Photometer .....                                | 123        |
| 8.5.1.1. Noisy or Unstable O <sub>3</sub> Readings at Zero.....                                 | 123        |
| 8.5.1.2. Noisy, Unstable, or Non-Linear Span O <sub>3</sub> Readings.....                       | 123        |
| 8.5.1.3. Slow Response to Changes in Concentration .....                                        | 123        |
| 8.5.1.4. The Analog Output Signal Level Does Not Agree With Input / Control Panel Readings..... | 124        |
| 8.5.1.5. Cannot Zero .....                                                                      | 124        |
| 8.5.1.6. Cannot Span .....                                                                      | 124        |
| 8.5.2. Checking Measure / Reference Valve.....                                                  | 124        |
| 8.6. Troubleshooting the O <sub>3</sub> Generator .....                                         | 125        |
| 8.7. Repair Procedures.....                                                                     | 125        |
| 8.7.1. Repairing Sample Flow Control Assembly.....                                              | 125        |

|                                                                             |            |
|-----------------------------------------------------------------------------|------------|
| 8.7.2. Disk-On-Module Replacement Procedure .....                           | 126        |
| 8.8. Technical Assistance .....                                             | 127        |
| <b>9. PRINCIPLES OF OPERATION.....</b>                                      | <b>129</b> |
| 9.1. Pneumatic Operation.....                                               | 129        |
| 9.1.1. Gas Flow Control.....                                                | 129        |
| 9.1.1.1. Photometer Critical Flow Orifice .....                             | 129        |
| 9.1.2. Internal Gas Pressure Sensors .....                                  | 130        |
| 9.2. Electronic Operation .....                                             | 131        |
| 9.2.1. Overview.....                                                        | 131        |
| 9.2.2. Central Processing Unit (CPU).....                                   | 132        |
| 9.2.2.1. Disk On Module (DOM).....                                          | 133        |
| 9.2.2.2. Flash Chip .....                                                   | 133        |
| 9.2.3. Power Distribution Board.....                                        | 133        |
| 9.2.3.1. Valve Control.....                                                 | 134        |
| 9.2.3.2. Heater Control.....                                                | 134        |
| 9.2.3.3. Power Distribution Board Status LEDs and Watch Dog Circuitry ..... | 134        |
| 9.2.3.4. Power Distribution Board Watchdog Indicator (D1) .....             | 135        |
| 9.2.4. Motherboard .....                                                    | 136        |
| 9.2.5. Power Supply and Circuit Breaker .....                               | 136        |
| 9.2.6. Internal Zero Air Pump DC Connections.....                           | 137        |
| 9.3. Input and Control Panel Touchscreen/Display Interface.....             | 138        |
| 9.3.1.1. Input and Control Panel Interface PCA.....                         | 138        |
| 9.4. Software Operation.....                                                | 139        |
| 9.5. O <sub>3</sub> Generator Operation .....                               | 139        |
| 9.5.1. Principle of Photolytic O <sub>3</sub> Generation .....              | 139        |
| 9.5.2. Generator Pneumatic Operation .....                                  | 141        |
| 9.5.3. O <sub>3</sub> Generator Electronic Operation.....                   | 141        |
| 9.5.3.1. O <sub>3</sub> Generator Temperature Control .....                 | 143        |
| 9.6. Photometer Operation .....                                             | 143        |
| 9.6.1. Measurement Method .....                                             | 144        |
| 9.6.1.1. Calculating O <sub>3</sub> Concentration.....                      | 144        |
| 9.6.1.2. The Measurement / Reference Cycle .....                            | 145        |
| 9.6.1.3. The Absorption Path .....                                          | 147        |
| 9.6.1.4. Interferent Rejection.....                                         | 148        |
| 9.6.2. Photometer Layout.....                                               | 148        |
| 9.6.3. Photometer Pneumatic Operation .....                                 | 149        |
| 9.6.4. Photometer Electronic Operation .....                                | 150        |
| 9.6.4.1. O <sub>3</sub> Photometer Temperature Control .....                | 151        |
| 9.6.4.2. Pneumatic Sensors for the O <sub>3</sub> Photometer.....           | 151        |

## LIST OF FIGURES

|              |                                                                |    |
|--------------|----------------------------------------------------------------|----|
| Figure 2-1:  | Control/Display and Input Panel.....                           | 20 |
| Figure 2-2:  | Display Screen and Touch Control .....                         | 20 |
| Figure 2-3:  | Communications and Output Panel .....                          | 21 |
| Figure 2-4:  | T753U Internal Layout.....                                     | 22 |
| Figure 2-5:  | T753U Pneumatic Diagram.....                                   | 23 |
| Figure 2-6:  | Analog Output Connector.....                                   | 25 |
| Figure 2-7:  | Status Output Connector.....                                   | 25 |
| Figure 2-8:  | Digital Control Input Connectors .....                         | 27 |
| Figure 2-9:  | Digital Control Output Connector .....                         | 28 |
| Figure 2-10: | Connector Pin-Outs for RS-232 Mode .....                       | 30 |
| Figure 2-11: | Jumper and Cables for Multidrop Mode .....                     | 32 |
| Figure 2-12: | RS-232-Multidrop PCA Host/Calibrator Interconnect Diagram..... | 33 |
| Figure 2-13: | Basic Pneumatic Setup .....                                    | 34 |
| Figure 2-14: | Status Screens at Startup .....                                | 36 |
| Figure 2-15: | Initial Home Page (in Standby Mode) .....                      | 36 |
| Figure 2-16: | Viewing Active Alerts Page .....                               | 37 |
| Figure 2-17: | Sample Dashboard Page .....                                    | 38 |
| Figure 2-18: | Basic Generate Initiation .....                                | 38 |
| Figure 3-1:  | User Interface Orientation .....                               | 41 |
| Figure 3-2:  | Dashboard Page .....                                           | 42 |
| Figure 3-3:  | Viewing a Live Plot from Dashboard Page.....                   | 42 |
| Figure 3-4:  | Navigating to the Active Alerts Page.....                      | 43 |
| Figure 3-5:  | Active Alerts Cleared.....                                     | 44 |
| Figure 3-6:  | Generate Page .....                                            | 44 |
| Figure 3-7:  | USB Utilities Pages .....                                      | 45 |
| Figure 3-8:  | Das download Page .....                                        | 46 |
| Figure 3-9:  | Configuration Transfer.....                                    | 46 |
| Figure 3-10: | Setup>Data Logging Page .....                                  | 48 |
| Figure 3-11: | Datalog Configuration, New Log Page.....                       | 48 |
| Figure 3-12: | Datalog Configuration.....                                     | 49 |
| Figure 3-13: | Datalog Periodic Trigger Configuration.....                    | 50 |
| Figure 3-14: | Datalog - Conditional Trigger Configuration.....               | 50 |
| Figure 3-15: | Events List.....                                               | 51 |
| Figure 3-16: | Event Configuration.....                                       | 52 |
| Figure 3-17: | Existing Event for Viewing or Editing .....                    | 52 |
| Figure 3-18: | Dashboard Configuration Page through Setup Menu.....           | 53 |
| Figure 3-19: | Dashboard Configuration Page through Dashboard Shortcut .....  | 53 |
| Figure 3-20: | Vars Configuration Page .....                                  | 54 |
| Figure 3-21: | Home Configuration through Setup>Homescreen Menu.....          | 54 |
| Figure 3-22: | Digital Status Outputs Setup .....                             | 55 |
| Figure 3-23: | Example List of Configured Sequences.....                      | 56 |
| Figure 3-24: | Configuring a Sequence.....                                    | 56 |
| Figure 3-25: | Levels Programming and Editing .....                           | 59 |
| Figure 3-26: | Analog Output Configuration.....                               | 60 |
| Figure 3-27: | Analog Output Auto Calibration Page .....                      | 61 |
| Figure 3-28: | Setup for Manually Calibrating the Analog Output.....          | 62 |
| Figure 3-29: | Analog Output Manual Calibration Page.....                     | 62 |
| Figure 3-30: | Setup>Instrument Menu.....                                     | 63 |
| Figure 3-31: | Date and Time Configuration Page.....                          | 64 |
| Figure 3-32: | Communications Configuration Page.....                         | 65 |
| Figure 3-33: | Network Configuration Page .....                               | 66 |
| Figure 4-1:  | Activating the Generate Mode.....                              | 69 |
| Figure 4-2:  | Set up to Measure an External O <sub>3</sub> Source .....      | 72 |
| Figure 4-3:  | Viewing Concentration from External Ozone Source.....          | 73 |
| Figure 4-4:  | Output Pressure Regulator Assembly.....                        | 74 |

|              |                                                                                                          |     |
|--------------|----------------------------------------------------------------------------------------------------------|-----|
| Figure 5-1:  | MODBUS via Ethernet .....                                                                                | 77  |
| Figure 5-2:  | MODBUS via Serial Communication (example).....                                                           | 78  |
| Figure 6-1:  | Set up for Verifying O <sub>3</sub> Photometer Using Internal O <sub>3</sub> Generator .....             | 79  |
| Figure 6-2:  | Set up for Verifying Optional O <sub>3</sub> Photometer Using an External O <sub>3</sub> Generator ..... | 80  |
| Figure 6-3:  | O <sub>3</sub> Photometer Bench Cal .....                                                                | 81  |
| Figure 6-4:  | Back Pressure Compensation.....                                                                          | 82  |
| Figure 6-5:  | Pressure Calibration Monitor Points.....                                                                 | 84  |
| Figure 6-6:  | Pressure Regulator Monitor Connection Point.....                                                         | 84  |
| Figure 6-7:  | O <sub>3</sub> Regulator Pressure Monitor Point.....                                                     | 85  |
| Figure 6-8:  | Pressure Ca .....                                                                                        | 86  |
| Figure 6-9:  | Input Port of Photometer Bench.....                                                                      | 88  |
| Figure 6-10: | Photometer Flow Calibration Page .....                                                                   | 88  |
| Figure 6-11: | Output Gas Flow Calibration Page.....                                                                    | 89  |
| Figure 6-12: | Analog Inputs Calibration Page.....                                                                      | 89  |
| Figure 7-1:  | Report Generation Page .....                                                                             | 95  |
| Figure 7-2:  | Remote Update Page.....                                                                                  | 95  |
| Figure 7-3:  | Manual Update Page (and other utilities).....                                                            | 96  |
| Figure 7-4:  | Leak Check Setup, Basic Pneumatics .....                                                                 | 98  |
| Figure 7-5:  | Leak Check Setup, with Internal Zero Air Option.....                                                     | 99  |
| Figure 7-6:  | Photometer – Location of UV Detector Gain Adjustment & UV Lamp Set Screw.....                            | 102 |
| Figure 7-7:  | O <sub>3</sub> Generator UV Lamp Location .....                                                          | 104 |
| Figure 8-1:  | CPU Status Indicator.....                                                                                | 110 |
| Figure 8-2:  | Power Distribution Board Status LEDs Used for Troubleshooting.....                                       | 111 |
| Figure 8-3:  | Location of DC Power Test Points on Power distribution board .....                                       | 114 |
| Figure 8-4:  | Analog Outputs Page .....                                                                                | 118 |
| Figure 8-5:  | Critical Flow Restrictor Assembly Disassembly .....                                                      | 126 |
| Figure 9-1:  | Location of Gas Flow Control Assemblies .....                                                            | 129 |
| Figure 9-2:  | Electronic Block Diagram .....                                                                           | 131 |
| Figure 9-3:  | CPU Board Annotated.....                                                                                 | 132 |
| Figure 9-4:  | Power Distribution Board.....                                                                            | 133 |
| Figure 9-5:  | Heater Control Loop Block Diagram. ....                                                                  | 134 |
| Figure 9-6:  | Status LED Locations – Power Distribution Board.....                                                     | 135 |
| Figure 9-7:  | Power Distribution Block diagram .....                                                                   | 137 |
| Figure 9-8:  | Internal Z/A Pump DC Connection.....                                                                     | 137 |
| Figure 9-9:  | Input and Control Panel Layout.....                                                                      | 138 |
| Figure 9-10: | Schematic of Basic Software Operation.....                                                               | 139 |
| Figure 9-11: | O <sub>3</sub> Generator Internal Pneumatics .....                                                       | 140 |
| Figure 9-12: | O <sub>3</sub> Generator Valve and Gas Fixture Locations.....                                            | 141 |
| Figure 9-13: | O <sub>3</sub> Generator Electronic Block Diagram.....                                                   | 142 |
| Figure 9-14: | O <sub>3</sub> Generator Electronic Components Location .....                                            | 142 |
| Figure 9-15: | O <sub>3</sub> Generator Temperature Thermistor and DC Heater Locations .....                            | 143 |
| Figure 9-16: | T753U O <sub>3</sub> Photometer Gas Flow – Measure Cycle .....                                           | 146 |
| Figure 9-17: | T753U O <sub>3</sub> Photometer Gas Flow – Reference Cycle.....                                          | 147 |
| Figure 9-18: | O <sub>3</sub> Photometer Absorption Path.....                                                           | 148 |
| Figure 9-19: | O <sub>3</sub> Photometer Layout – Top Cover Removed .....                                               | 149 |
| Figure 9-20: | O <sub>3</sub> Photometer Electronic Block Diagram .....                                                 | 150 |

## LIST OF TABLES

|            |                                                                                                   |    |
|------------|---------------------------------------------------------------------------------------------------|----|
| Table 1-1: | T753U System Specifications (Based on constant conditions. Subject to change without notice)..... | 17 |
| Table 2-1: | Communications and Output Panel Description .....                                                 | 21 |
| Table 2-2: | Status Output Pin Assignments .....                                                               | 26 |
| Table 2-3: | Control Input Pin Assignments.....                                                                | 26 |

|             |                                                                               |     |
|-------------|-------------------------------------------------------------------------------|-----|
| Table 2-4:  | Control Output Pin Assignments .....                                          | 28  |
| Table 3-1:  | Menu Overview .....                                                           | 39  |
| Table 3-2:  | Automatic Calibration Sequence Set Up Attributes .....                        | 57  |
| Table 3-3:  | Analog Output Voltage Range Min/Max.....                                      | 61  |
| Table 3-4:  | Voltage Tolerances for the Analog Output Calibration.....                     | 62  |
| Table 3-5:  | COM1/COM2 Configuration .....                                                 | 65  |
| Table 3-6:  | LAN/Ethernet Configuration Properties.....                                    | 67  |
| Table 5-1:  | Ethernet Status Indicators .....                                              | 76  |
| Table 6-1:  | T753U Pressure Sensors.....                                                   | 83  |
| Table 6-2:  | T753U Gas Pressure to Output Flow Conversions.....                            | 87  |
| Table 7-1:  | T753U Maintenance Schedule.....                                               | 93  |
| Table 7-2:  | Desiccant Usage Estimates at 5 LPM Flow .....                                 | 101 |
| Table 8-1:  | Possible Alerts.....                                                          | 106 |
| Table 8-2:  | Dashboard Functions (Tags) - Indicated Failures.....                          | 107 |
| Table 8-3:  | Signal Outputs as Diagnostic Tools .....                                      | 109 |
| Table 8-4:  | Power Distribution Board Watchdog LED Failure Indications.....                | 111 |
| Table 8-5:  | Power Distribution Board Status LED Failure Indications.....                  | 112 |
| Table 8-6:  | DC Power Test Point and Wiring Color Codes .....                              | 114 |
| Table 8-7:  | DC Power Supply Acceptable Levels.....                                        | 115 |
| Table 8-8:  | Power Distribution Board Control Devices .....                                | 116 |
| Table 8-9:  | Analog Output Test Function - Nominal Values Voltage Outputs.....             | 119 |
| Table 8-10: | T753U Digital Control Input Pin Assignments and Corresponding Functions ..... | 119 |
| Table 8-11: | Control Outputs Pin Assignments and Corresponding Functions Check .....       | 120 |
| Table 9-1:  | Pressure Sensors and their Descriptions.....                                  | 130 |
| Table 9-2:  | Power Distribution Board Status LEDs .....                                    | 135 |
| Table 9-3:  | Photometer Measurement / Reference Cycle.....                                 | 145 |

## APPENDIX

### APPENDIX – INTERCONNECT DIAGRAM

This page intentionally left blank.



# 1. INTRODUCTION

The Model T753U is a portable, microprocessor-controlled calibrator for precision ambient ozone instruments, featuring an internal ozone photometer that provides very accurate closed loop feedback control of the ozone concentration. The T753U includes the ability to generate ozone in a low range (fractional mode), for ultra-low ozone production.

As many as 50 independent calibration sequences may be programmed into the T753U, covering time periods of up to one year. The setup of sequences is simple and intuitive. These sequences may be actuated manually, automatically, or by a remote signal. The sequences may be uploaded remotely, including remote editing. All programs are maintained in non-volatile memory.

The T753U design emphasizes fast response, repeatability, overall accuracy and ease of operation. It may be combined with the Model 701 Zero Air Generator to provide the ultimate in easy to use, precise calibration for your ozone instruments.

Some of the exceptional features of your T753U Portable Photometric O<sub>3</sub> Calibrator are:

- Advanced T-Series electronics
- ultra-low ozone production down to 2 ppb
- Internal ozone generator and photometer allows use as primary or transfer standard
- LCD Graphical User Interface with capacitive touch screen
- Bi directional RS-232, 10/100Base-T Ethernet, a USB port and optional RS485 for remote operation
- Additional USB ports for peripheral devices and firmware upgrades
- 12 independent timers for sequences
- Nested sequences (up to 5 levels)
- Flow adjustable: 2-5 lpm (with internal zero air source option) or 2-15 lpm (with external zero air source)
- Inlets for external ozone reference sources
- UV Lamp Feedback modes: current control; photometer control

## 1.1. OPTIONS

| Option                                                                                     | Option Number | Description/Notes                                                                                                                                              |                                                                                                                                                                     |
|--------------------------------------------------------------------------------------------|---------------|----------------------------------------------------------------------------------------------------------------------------------------------------------------|---------------------------------------------------------------------------------------------------------------------------------------------------------------------|
| <b>Kits</b>                                                                                |               |                                                                                                                                                                |                                                                                                                                                                     |
|                                                                                            | 42A           | Annual Maintenance Kit for One Unit                                                                                                                            |                                                                                                                                                                     |
| <b>Communications</b>                                                                      |               | <b>For remote serial, network and Internet communication with the analyzer.</b>                                                                                |                                                                                                                                                                     |
|                                                                                            |               | Type                                                                                                                                                           | Description                                                                                                                                                         |
| Cables                                                                                     | 60A           | RS-232                                                                                                                                                         | Shielded, straight-through DB-9F to DB-25M cable, about 1.8 m long. Used to interface with older computers or code activated switches with DB-25 serial connectors. |
|                                                                                            | 60B           | RS-232                                                                                                                                                         | Shielded, straight-through DB-9F to DB-9F cable of about 1.8 m length.                                                                                              |
|                                                                                            | 60C           | Ethernet                                                                                                                                                       | Patch cable, 2 meters long, used for Internet and LAN communications.                                                                                               |
|                                                                                            | 60D           | USB                                                                                                                                                            | Com Port Cable.                                                                                                                                                     |
| USB Port                                                                                   | 64A           | For communications and output panel connection to personal computer.                                                                                           |                                                                                                                                                                     |
| RS-232 Multidrop                                                                           | 62            | Multidrop/LVDS card seated on the analyzer's CPU card.<br>Each instrument in the multidrop network requires this card and a communications cable (Option 60B). |                                                                                                                                                                     |
| <b>NIST Traceable, Primary Standard Certification for use as a Primary Ozone Standard.</b> |               |                                                                                                                                                                |                                                                                                                                                                     |
|                                                                                            | 95C           | Calibration to NIST-SRP                                                                                                                                        |                                                                                                                                                                     |
|                                                                                            | 95D           | Calibration as a Transfer Standard (6x6)                                                                                                                       |                                                                                                                                                                     |

The Model T753U can be used as a Primary Ozone Standard. For this application the performance of the T753U Portable Calibrator is calibrated to Standard Reference Photometer (SRP) Calibrators ordered with this option are verified and validated in accordance with the procedures prescribed by the U.S. Environmental Protection Agency (EPA) under Title 40 of the Code of Federal Regulations, Part 50, Appendix D (40 CFR Part 50).

## 1.2. SPECIFICATIONS

**Table 1-1: T753U System Specifications**

| PARAMETER                              | SPECIFICATION                                                                                                                                                           |                                                                    |
|----------------------------------------|-------------------------------------------------------------------------------------------------------------------------------------------------------------------------|--------------------------------------------------------------------|
| Flow Rate (w/internal zero air source) | 2 to 5 LPM adjustable                                                                                                                                                   |                                                                    |
| Flow Rate (w/external zero air source) | 2 to 15 LPM adjustable                                                                                                                                                  |                                                                    |
| Linearity                              | ± 1.0% of full scale                                                                                                                                                    |                                                                    |
| Precision                              | 1.0 ppb                                                                                                                                                                 |                                                                    |
| Response Time                          | < 240 seconds to 95%                                                                                                                                                    |                                                                    |
| Span Drift (7-days)                    | <1% w/ photometer feedback; <3% w/o photometer feedback (CNST)                                                                                                          |                                                                    |
| Maximum Output                         | 2.5 ppm LPM                                                                                                                                                             |                                                                    |
| Minimum Output                         | 10 ppb LPM                                                                                                                                                              |                                                                    |
| Maximum Ozone Concentration            | 1250 ppb at 2 LPM                                                                                                                                                       |                                                                    |
| Minimum Ozone Concentration            | 2 ppb at 5 LPM                                                                                                                                                          |                                                                    |
| <b>Ozone Generator Module:</b>         | Minimum Concentration Output:                                                                                                                                           | 2 ppb                                                              |
|                                        | Response Time:                                                                                                                                                          | <180 seconds to 98%                                                |
| <b>UV Photometer:</b>                  | Range:                                                                                                                                                                  | 0 - 100 ppb to 0 - 10 ppm                                          |
|                                        | Rise/Fall Time:                                                                                                                                                         | < 20 seconds to 95% (photometer response)                          |
|                                        | Flow Rate:                                                                                                                                                              | 800 cc/min ±10%                                                    |
|                                        | Zero Drift:                                                                                                                                                             | < 1.0 ppb/24 hours                                                 |
| AC Power                               | Rating                                                                                                                                                                  | Typical Power Consumption                                          |
|                                        | 100V – 120V, 60Hz, 3.0 A<br>220V – 240V, 50/60Hz, 3.0 A                                                                                                                 | 81 W (with Zero Air Pump 115 W)<br>82 W (with Zero Air Pump 120 W) |
| Analog Output Ranges                   | 0.1 V, 1 V, 5 V or 10 V (selectable)                                                                                                                                    |                                                                    |
| Operating Temperature Range            | 5-40°C                                                                                                                                                                  |                                                                    |
| Humidity Range                         | 0 - 95% RH, non-condensing                                                                                                                                              |                                                                    |
| Environmental Conditions               | Installation Category (Over Voltage Category ) II<br>Pollution Degree 2<br>Intended for Indoor Use Only at Altitudes ≤ 2000m                                            |                                                                    |
| Dimensions (H x W x D)                 | 9" x 17" x 21" (229 mm x 432 mm x 533 mm)                                                                                                                               |                                                                    |
| Weight                                 | 38.5 lbs (17.5 kg) without internal zero air option; 41.5 lbs (18.8 kg) with option                                                                                     |                                                                    |
| Standard I/O                           | 1 Ethernet: 10/100 Base-T<br>2 RS-232 (300 – 115,200 baud)<br>2 USB device ports<br>12 digital control outputs<br>12 digital control inputs<br>8 digital status outputs |                                                                    |
| Optional I/O                           | 1 USB com port<br>1 RS485<br>Multidrop RS232                                                                                                                            |                                                                    |

Specifications are subject to change without notice.

All specifications are based on constant conditions.

### **1.3. COMPLIANCE AND CERTIFICATIONS**

This product is CE compliant and adheres to the Low Voltage and ElectroMagnetic Compatibility directives.

For any other certifications, please refer to this product's specifications sheet on our website.

## 2. GETTING STARTED

### 2.1. UNPACKING

Please note the following cautionary messages, and then proceed to the steps for unpacking.

#### CAUTION – AVOID PERSONAL INJURY



The T753U weighs 41.5 lbs (18.8 kg) with the internal zero air option, or 38.5 lbs (17.5 kg) without. To avoid personal injury, we recommend using two persons and proper lift and carry techniques to move/relocate the calibrator.

#### CAUTION – AVOID WARRANTY INVALIDATION



Printed circuit assemblies (PCAs) are sensitive to electro-static discharges too small to be felt by the human nervous system. Failure to use Electro-Static Discharge (ESD) protection when working with electronic assemblies will void the instrument warranty. Refer to the manual, Fundamentals of ESD, PN 04786, which can be downloaded from our website at: <http://www.teledyne-api.com>.

#### CAUTION – AVOID DAMAGE TO THE INSTRUMENT



**BEFORE** operating instrument, remove dust plugs from pneumatic ports.

**NEVER** allow instrument to run with the case closed – keep lid open to vent while operating.

**NEVER** attempt to lift the T753U by the interior handles attached to the control/display and input panel.

#### Note

Although this product is portable, it must be properly packaged any time it ships for any reason; it is recommended that you store shipping containers/materials for such use. See Warranty page in this manual and shipping procedures on our Website at <http://www.teledyne-api.com> under Customer Support>Return Authorization

#### WARNING – ELECTRICAL SHOCK HAZARD



Never disconnect or reconnect electronic circuit boards, wiring harnesses or electronic subassemblies while the unit is under power.

1. Inspect the received package(s) for external shipping damage. If damaged, please advise the shipper first, then Teledyne API.
2. Remove the T753U from its shipping carton.
3. Open the lid and check for damage inside.

4. Check the line voltage and frequency label on the instrument to ensure that it matches the local power source.

## 2.2. INSTRUMENT LAYOUT

### 2.2.1. INPUT AND CONTROL PANEL

Figure 2-1 shows the location of the Input and Control Panel components. Figure 2-2 shows the display screen that is described in Figure 2-2.

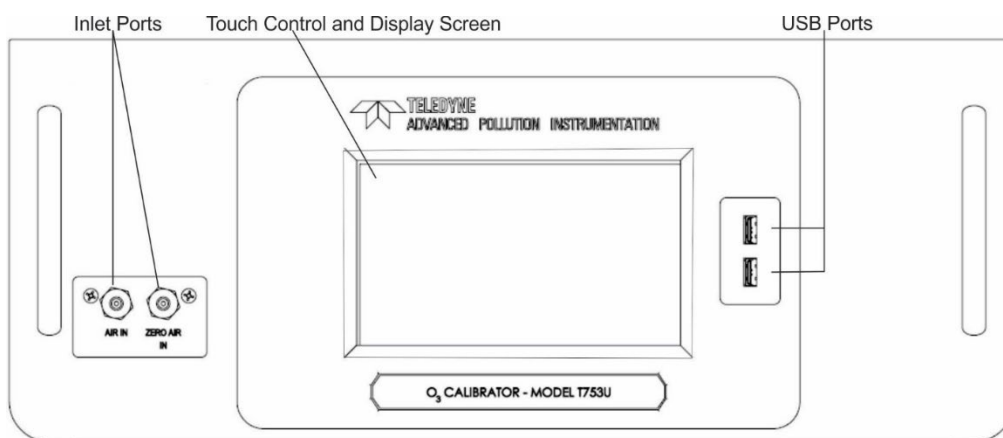

**Figure 2-1: Control/Display and Input Panel**

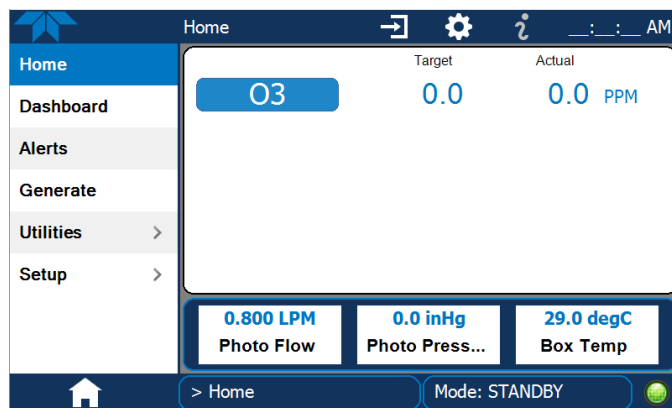

**Figure 2-2: Display Screen and Touch Control**

The Input and Control Panel liquid crystal display (LCD) screen includes touch control. Upon calibrator start-up, the LCD shows a splash screen and other initialization indicators before the main display appears.

CAUTION – AVOID DAMAGING TOUCHSCREEN

**Do not use hard-surfaced instruments such as pens to operate the touch screen**

## 2.2.2. COMMUNICATIONS AND OUTPUT PANEL

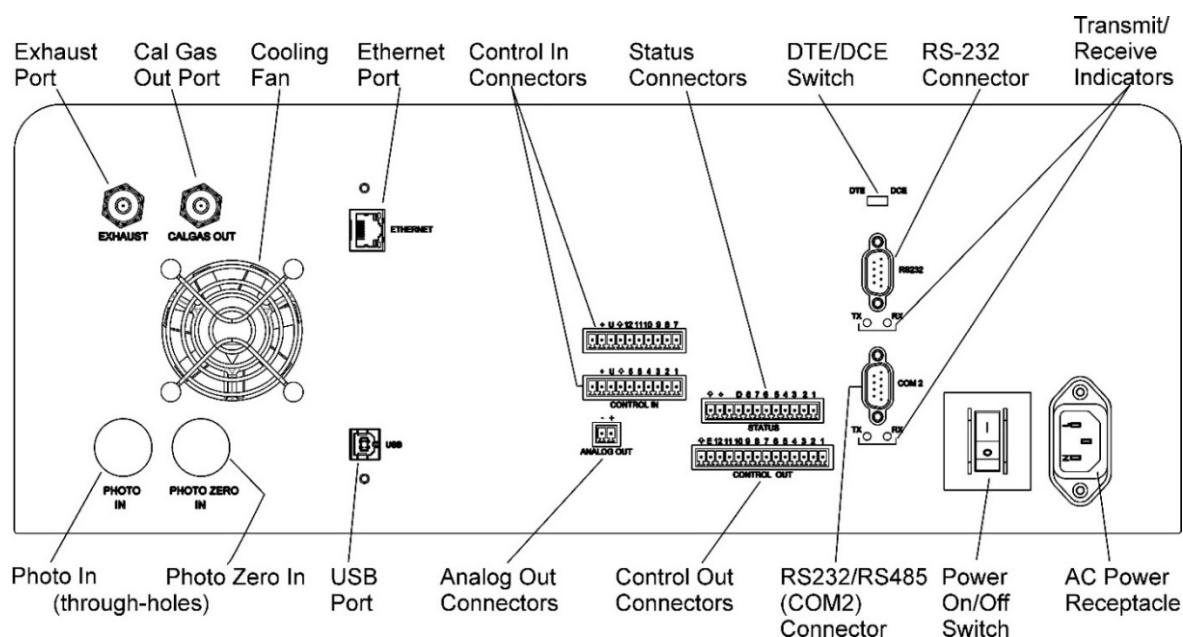

**Figure 2-3: Communications and Output Panel**

**Table 2-1: Communications and Output Panel Description**

| COMPONENT                 | FUNCTION                                                                                                                   |
|---------------------------|----------------------------------------------------------------------------------------------------------------------------|
| <b>EXHAUST</b>            | Exhaust gas from ozone generator (and from photometer option if installed) – must be vented out of area.                   |
| <b>CAL GAS OUT</b>        | Outlet for calibration gas                                                                                                 |
| <b>Fan</b>                | For cooling: pulls ambient air through chassis from side vents; exhausts through rear.                                     |
| <b>ETHERNET</b>           | Connector for network or Internet remote communication, using Ethernet cable.                                              |
| <b>CONTROL IN</b>         | For remotely activating the zero and span calibration modes.                                                               |
| <b>STATUS</b>             | For outputs to devices such as Programmable Logic Controllers (PLCs).                                                      |
| <b>DCE DTE</b>            | Switch to select either data terminal equipment or data communication equipment during RS-232 communication. (Section 5.2) |
| <b>RS-232</b>             | Serial communications port for RS-232 only.                                                                                |
| <b>RX TX</b>              | LEDs indicate receive (RX) and transmit (TX) activity on the when blinking.                                                |
| <b>COM 2</b>              | Serial communications port for RS-232 or RS-485 (option).                                                                  |
| <b>AC Power Connector</b> | Connector for three-prong cord to apply AC power to the instrument                                                         |
| <b>Rocker switch</b>      | Power on/off control                                                                                                       |
| <b>CONTROL OUT</b>        | For outputs to devices such as Programmable Logic Controllers (PLCs).                                                      |
| <b>ANALOG OUT</b>         | For voltage or current loop outputs to a strip chart recorder and/or a data logger.                                        |
| <b>USB</b>                | Connector for direct connection (option) to a personal computer, using USB cable.                                          |
| <b>PHOTO IN</b>           | Measurement gas input for O <sub>3</sub> photometer (option)                                                               |
| <b>PHOTO ZERO IN</b>      | Inlet for photometer Zero Gas (option)                                                                                     |
| <b>ZERO AIR IN</b>        | Inlet for external zero air source – MUST BE CAPPED WHEN NOT CONNECTED.                                                    |

### 2.2.3. INTERNAL LAYOUT

Figure 2-4 shows the internal layout of T753U, and Figure 2-5 shows the pneumatic flow.

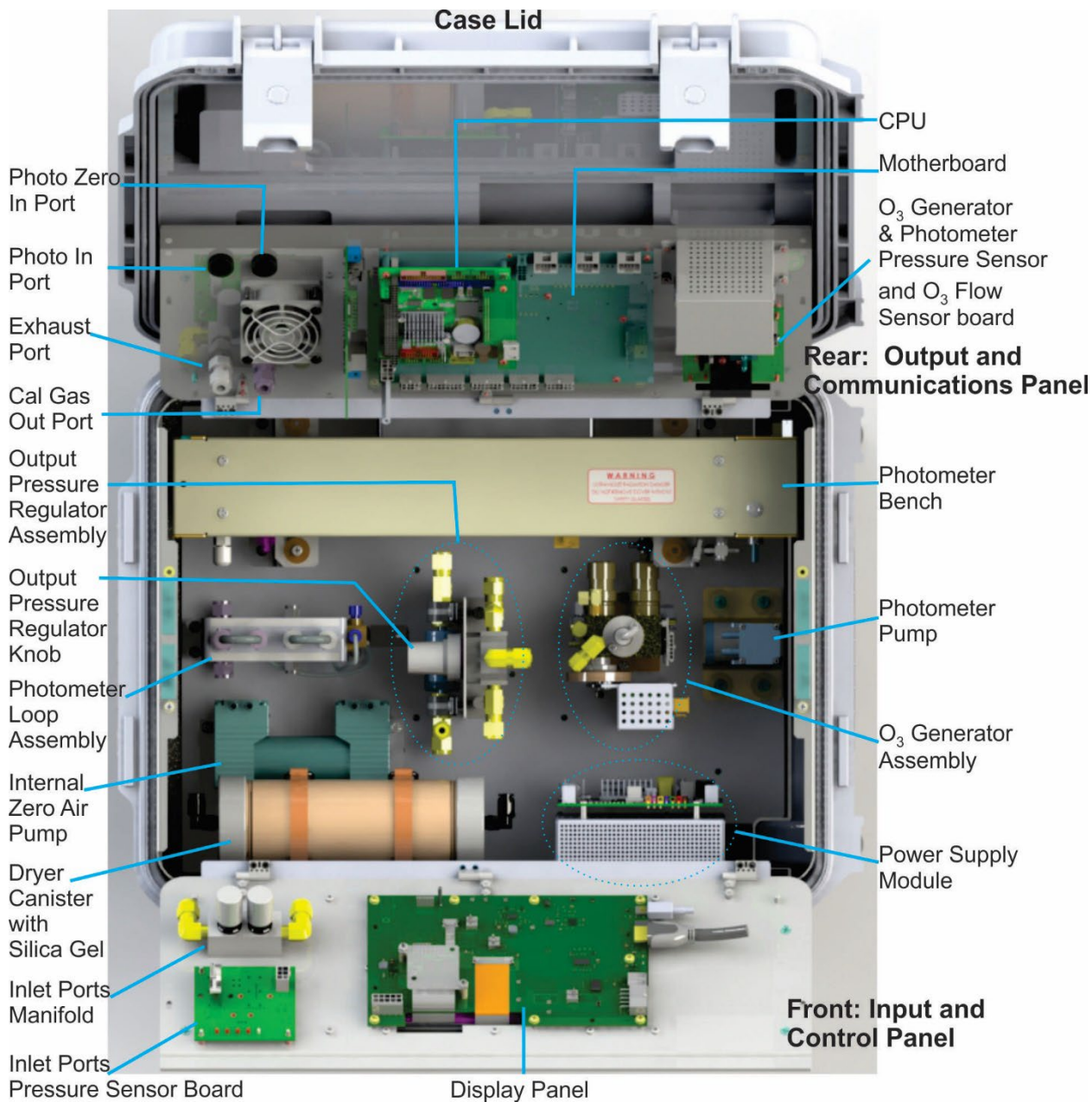

Figure 2-4: T753U Internal Layout



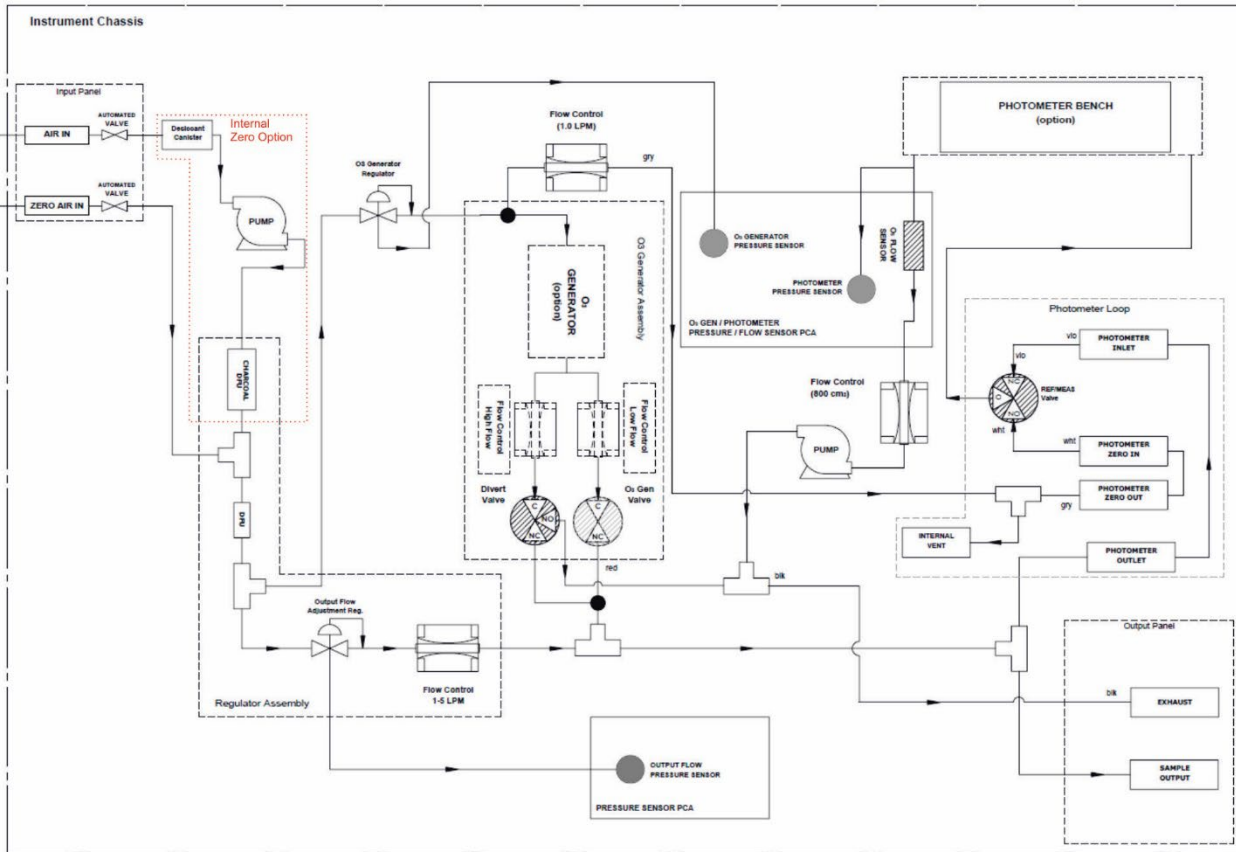

Figure 2-5: T753U Pneumatic Diagram

## 2.3. CONNECTIONS AND STARTUP

This section presents the electrical (Section 2.3.1) and pneumatic (Section 2.3.2) connections for setting up and preparing the instrument for initial startup, which is presented in Section 2.4).

### 2.3.1. ELECTRICAL CONNECTIONS

**Note**

To maintain compliance with EMC standards, it is required that the power cord length be no greater than 3 meters.

#### 2.3.1.1. Power Connection

Verify the correct line voltage and frequency configuration on the serial number tag of the T753U.

Connect the power cord from the calibrator's AC power receptacle to the proper power source.

#### WARNING – ELECTRICAL SHOCK HAZARD



- High Voltages are present inside the calibrator's case.
- Power connection must have functioning ground connection.
- Ensure that the power cord is properly grounded and adequately rated for the power rating of this instrument (see Specifications table).
- Turn off calibrator power before disconnecting or connecting electrical subassemblies.

#### CAUTION – AVOID PERSONAL INJURY



- DO NOT LOOK AT THE PHOTOMETER UV LAMP.
- UV LIGHT CAN CAUSE EYE DAMAGE.
- ALWAYS WEAR GLASSES MADE FROM SAFETY UV FILTERING GLASS (PLASTIC GLASSES ARE INADEQUATE).

### 2.3.1.2. Connecting the Analog Output Channel

The analog output channel must be set by the user who can map it to any one of several functions, such as concentration value, temperatures, pressures, etc. The output signals range between 0 and 5 VDC.

To access these signals attach a strip chart recorder and/or data-logger to the analog output connector on the communications and output panel of the calibrator.

Configure and calibrate this channel through the Setup>Analog Outputs menu (Section 3.3.9), and view its output from the Utilities>Diagnostics>Analog Outputs menu.

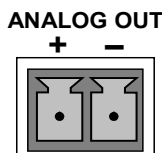

Figure 2-6: Analog Output Connector

### 2.3.1.3. Connecting the Status Outputs (Digital Outputs)

The status outputs report calibrator conditions via optically isolated NPN transistors, which sink up to 50 mA of DC current. These outputs can be used to interface with devices that accept logic-level digital inputs, such as programmable logic controllers (PLCs). Each Status bit is an open collector output that can withstand up to 40 VDC. All of the emitters of these transistors are tied together and available at pin D.

#### ATTENTION

#### COULD DAMAGE INSTRUMENT AND VOID WARRANTY

Most PLC's have internal provisions for limiting the current that the input will draw from an external device. When connecting to a unit that does not have this feature, an external dropping resistor must be used to limit the current through the transistor output to less than 50 mA. At 50 mA, the transistor will drop approximately 1.2V from its collector to emitter.

The status outputs are accessed via a 12-pin connector on the calibrator's communications and output panel labeled STATUS. The function of each pin is defined in Table 2-2. Select each output as desired and map to the signals available in the Setup>Digital Outputs.

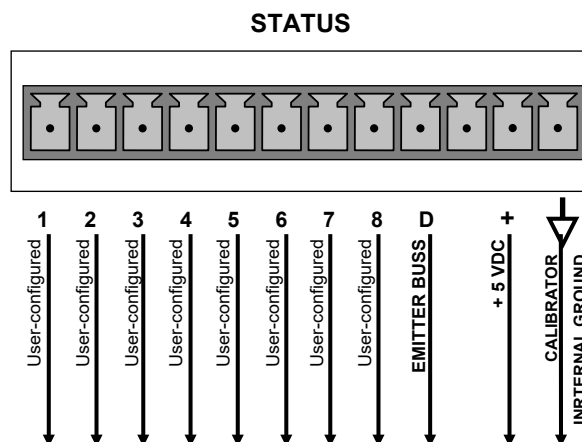



Figure 2-7: Status Output Connector

**Table 2-2: Status Output Pin Assignments**

| OUTPUT #                                                                          | STATUS DEFINITION    | CONDITION                                                           |
|-----------------------------------------------------------------------------------|----------------------|---------------------------------------------------------------------|
| 1-8                                                                               | <b>User-selected</b> |                                                                     |
| D                                                                                 | Emitter BUSS         | The emitters of the transistors on pins 1 to 8 are bussed together. |
| (blank)                                                                           | No connection        |                                                                     |
| +                                                                                 | DC POWER             | + 5 VDC                                                             |
|  | Digital Ground       | The ground level from the calibrator's internal DC power supplies.  |

### 2.3.1.4. Connecting the Control Inputs (Digital Inputs)

The calibrator is equipped with 12 digital control inputs that can be used to initiate various user programmable calibration sequences and can be turned ON or OFF in the Utilities>Diagnostics menu.

Access to these inputs is via 2 separate 10-pin connectors, labeled CONTROL IN, that are located on the calibrator's communications and output panel.

**Table 2-3: Control Input Pin Assignments**

| CONNECTOR               | INPUT                                                                               | DESCRIPTION                                                                                                                                          |
|-------------------------|-------------------------------------------------------------------------------------|------------------------------------------------------------------------------------------------------------------------------------------------------|
| <b>labeled + thru 1</b> | <b>1 to 6</b>                                                                       | Can be used as either 6 separate on/off switches or as bits 1 through 6 of a 12 bit wide binary activation code (see Section 0)                      |
| <b>labeled + thru 7</b> | <b>7 to 12</b>                                                                      | Can be used as either 6 separate on/off switches or as bits 7 through 12 of a 12 bit wide binary activation code (see Section 0)                     |
| <b>both</b>             |  | Chassis ground.                                                                                                                                      |
| <b>labeled + thru 1</b> | <b>U</b>                                                                            | Input pin for +5 VDC required to activate pins 1 – 6. This can be from an external source or from the “+” pin of the instrument's STATUS connector.  |
| <b>labeled + thru 7</b> | <b>U</b>                                                                            | Input pin for +5 VDC required to activate pins 7 – 12. This can be from an external source or from the “+” pin of the instrument's STATUS connector. |
| <b>both</b>             | <b>+</b>                                                                            | Internal source of +5V used to actuate control inputs when connected to the U pin.                                                                   |

There are two methods for energizing the control inputs (Figure 2-8): The internal +5V available from the pin labeled “+” is the most convenient method. However, if full isolation is required, an external 5 VDC power supply should be used.

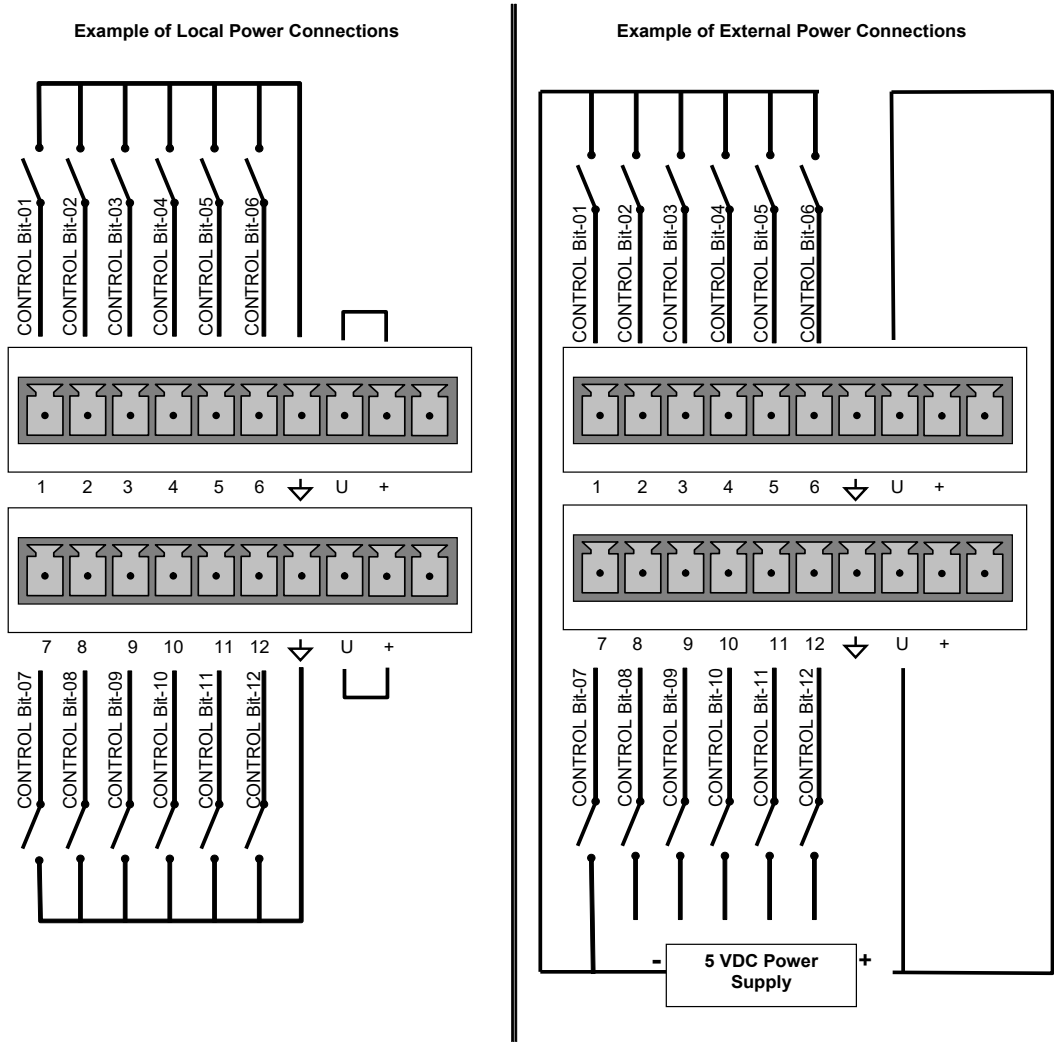

Figure 2-8: Digital Control Input Connectors

### 2.3.1.5. Connecting the Control Outputs (Digital Outputs)

The calibrator is equipped with 12 opto-isolated, digital control outputs, which may be used to interface with devices that accept logic-level digital inputs, such as programmable logic controllers (PLCs), data loggers, or digital relays/valve drivers.

These outputs are accessed via a 14-pin connector on the calibrator's communications and output panel and can be activated in any of three places in the Setup>Sequence menu (see Section 4.1.4 for instructions on assigning the control outputs to specific calibration sequences or as a default method when sequences are not running).

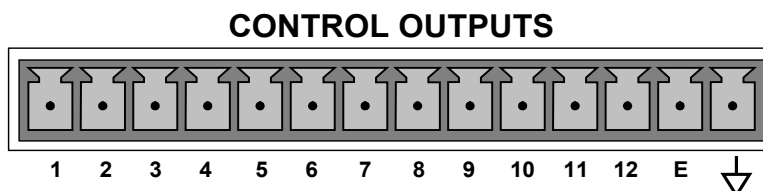

Figure 2-9: Digital Control Output Connector

**Note**

Most PLCs have internal provisions for limiting the current the input will draw. When connecting to a unit that does not have this feature, external resistors must be used to limit the current through the individual transistor outputs to  $\leq 50\text{mA}$  ( $120\ \Omega$  for 5V supply).

Table 2-4: Control Output Pin Assignments

| PIN #  | STATUS DEFINITION                 | CONDITION                                                              |
|--------|-----------------------------------|------------------------------------------------------------------------|
| 1 - 12 | Outputs 1 through 12 respectively | Closed if the sequence or sequence step activating output is operating |
| E      | Emitter BUSS                      | The emitters of the transistors on pins 1 to 8 are bussed together.    |
| ↓      | Digital Ground                    | The ground level from the calibrator's internal DC power supplies.     |

### 2.3.1.6. Connecting the Communication Interfaces

The T-Series instruments are equipped with connectors for remote communications interfaces (see Section 4.4 for resetting the output flow rate).

In addition to using the appropriate cables, each type of communication method must be configured using the Setup>Comm menu, which is presented later in this manual (Section 3.3.11).

#### ETHERNET CONNECTION

For network or Internet communication with the instrument, connect an Ethernet cable from Ethernet interface connector to an Ethernet port.

The T753U firmware supports dynamic IP addressing or DHCP for remote operation via an Ethernet connection. Although the calibrator is shipped with DHCP enabled by default, it should be manually assigned a static IP address (Setup>Comm>Network Settings menu, Section 3.3.11.4).

#### USB OPTION CONNECTION

For direct communication between the instrument and a personal computer (PC), connect a USB cable between the instrument and desktop or laptop USB ports. (If this option is installed, the COM2 port can only be used for RS232 multidrop communication). Computer and instrument baud rates must match (Setup>Comm>COM[1, 2] menu, Section 3.3.11.1).

#### RS-232 AND RS-485 CONNECTION

For **RS-232** communications with data terminal equipment (**DTE**) or with data communication equipment (**DCE**) connect either a DB9-female-to-DB9-female cable (Option 60B) or a DB9-female-to-DB25-male cable (Option 60A), as applicable, from the communications and output panel RS-232 port to the device.

#### Important

#### IMPACT ON READINGS OR DATA

**Cables that appear to be compatible because of matching connectors may incorporate internal wiring that makes the link inoperable. Check cables acquired from sources other than Teledyne API for pin assignments (Figure 2-10) before using.**

#### RS-232 COM PORT CONNECTOR PIN-OUTS

Electronically, the difference between the DCE and DTE is the pin assignment of the Data Receive and Data Transmit functions.

- DTE devices receive data on pin 2 and transmit data on pin 3.
- DCE devices receive data on pin 3 and transmit data on pin 2.

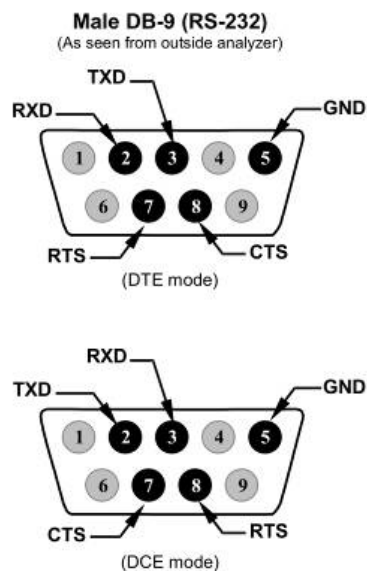

**Figure 2-10: Connector Pin-Outs for RS-232 Mode**

Teledyne API offers two mating cables, one of which should be applicable for your use.

P/N WR000077, a DB-9 female to DB-9 female cable, 6 feet long. Allows connection of the serial ports of most personal computers.

P/N WR000024, a DB-9 female to DB-25 male cable. Allows connection to the most common styles of modems (e.g. Hayes-compatible) and code activated switches.

Both cables are configured with straight-through wiring and should require no additional adapters.

**Note**

**Cables that appear to be compatible because of matching connectors may incorporate internal wiring that makes the link inoperable. Check cables acquired from sources other than Teledyne API for pin assignments before using.**

To assist in properly connecting the serial ports to either a computer or a modem, there are activity indicators just below the RS-232 port. Once a cable is connected between the calibrator and a computer or modem, both the red and green LEDs should be on.

If the LEDs are not lit, locate the small switch on the communications and output panel to switch it between DTE and DCE modes.

If both LEDs are still not illuminated, ensure that the cable properly constructed.



## RS-232 COM PORT DEFAULT SETTINGS

Received from the factory, the calibrator is set up to emulate a DCE or modem, with Pin 3 of the DB-9 connector designated for receiving data and Pin 2 designated for sending data. (See Section 3.3.11 for configuration).

- **RS-232 (COM1):** RS-232 (fixed)  
**Baud rate:** 115200 bits per second (baud)  
**Data Bits:** 8 data bits with 1 stop bit  
**Parity:** None
- **COM2:** RS-232 (configurable to RS-485)  
**Baud rate:** 115200 bits per second (baud)  
**Data Bits:** 8 data bits with 1 stop bit  
**Parity:** None

## RS-232 MULTI-DROP (OPTION 62) CONNECTION

When the RS-232 Multidrop option is installed, connection adjustments and configuration through the menu system are required. This section provides instructions for the internal connection adjustments, then for external connections, and ends with instructions for menu-driven configuration.

### Note

**Because the RS-232 Multidrop option uses both the RS232 and COM2 DB9 connectors on the calibrator's communications and output panel to connect the chain of instruments, COM2 port is no longer available for separate RS-232 or RS-485 operation.**

### ATTENTION

#### COULD DAMAGE INSTRUMENT AND VOID WARRANTY

**Printed Circuit Assemblies (PCAs) are sensitive to electrostatic discharges too small to be felt by the human nervous system. Failure to use ESD protection when working with electronic assemblies will void the instrument warranty. For information on preventing ESD damage, see *Fundamentals of ESD* manual, PN 04786, available on our website at <http://www.teledyne-api.com> under Help Center>Product Manuals in the Special Manuals section.**

In each instrument with the Multidrop option there is a shunt jumpering two pins on the serial Multidrop and LVDS printed circuit assembly (PCA), as shown in Figure 2-11. This shunt must be removed from all instruments except that designated as last in the multidrop chain, which must remain terminated. This requires powering off and opening each instrument and making the following adjustments:

1. With NO power to the instrument, lay the communications and output panel open for access to the Multidrop/LVDS PCA, which is seated on the CPU.
2. On the Multidrop/LVDS PCA's JP2 connector, remove the shunt that jumpers Pins 21 ↔ 22 as indicated in. (Do this for all but the last instrument in the chain where the shunt should remain at Pins 21 ↔ 22).

3. Check that the following cable connections are made in all instruments (again refer to Figure 2-11, and note that the CPU's COM2 connector is not used in Multidrop):
  - J3 on the Multidrop/LVD S PCA to the CPU's COM1 connector
  - J4 on the Multidrop/LVDS PCA to J12 on the motherboard
  - J1 on the Multidrop/LVDS PCS to the LCD display and touchscreen panel

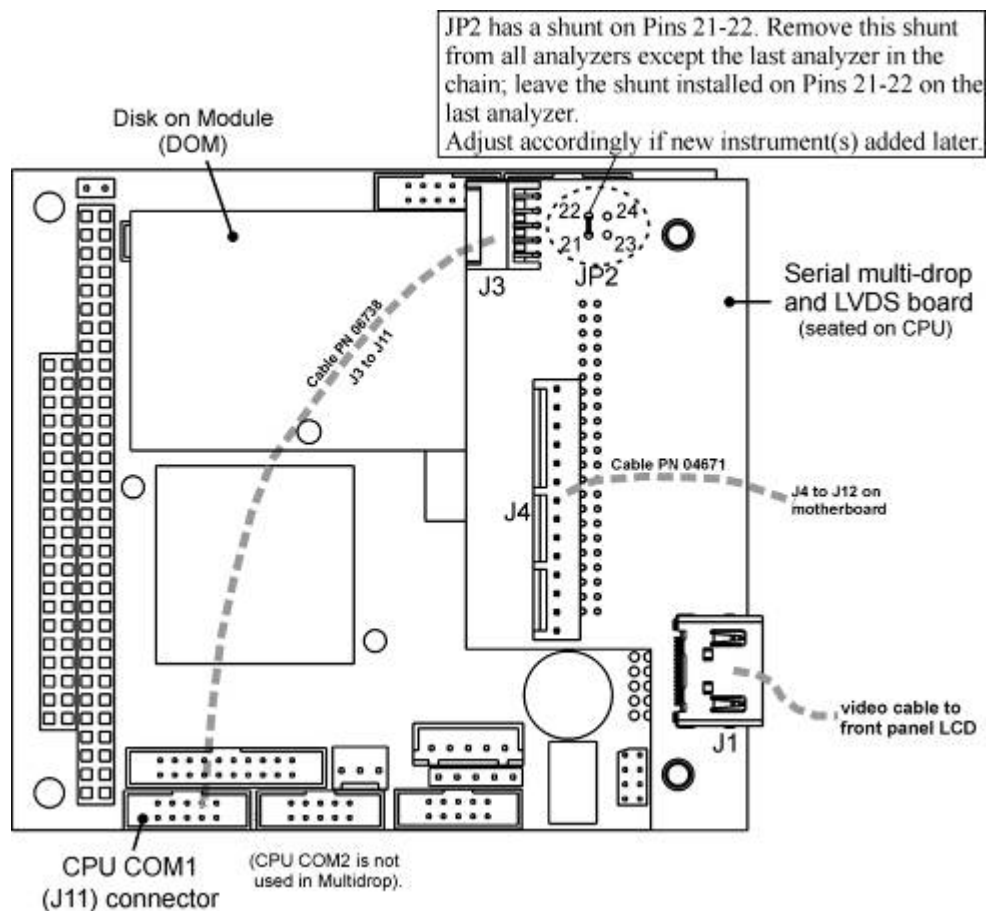

Figure 2-11: Jumper and Cables for Multidrop Mode

**Note**

If you are adding an instrument to the end of a previously configured chain, remove the shunt between Pins 21 – 22 of JP2 on the Multidrop/LVDS PCA in the instrument that was previously the last instrument in the chain.)

4. Close the instrument.
5. Referring to Figure 2-12 use straight-through DB9 male → DB9 female cables to interconnect the host RS232 port to the first calibrator's RS232 port; then from the first calibrator's COM2 port to the second calibrator's RS232 port; from the second calibrator's COM2 port to the third calibrator's RS232 port, etc., connecting in this fashion up to eight calibrators, subject to the distance limitations of the RS-232 standard.

6. On the communications and output panel of each calibrator, adjust the DCE DTE switch so that the green and the red LEDs (RX and TX) of the COM1 connector (labeled RS232) are both lit. (Ensure you are using the correct RS-232 cables internally wired specifically for RS-232 communication.)

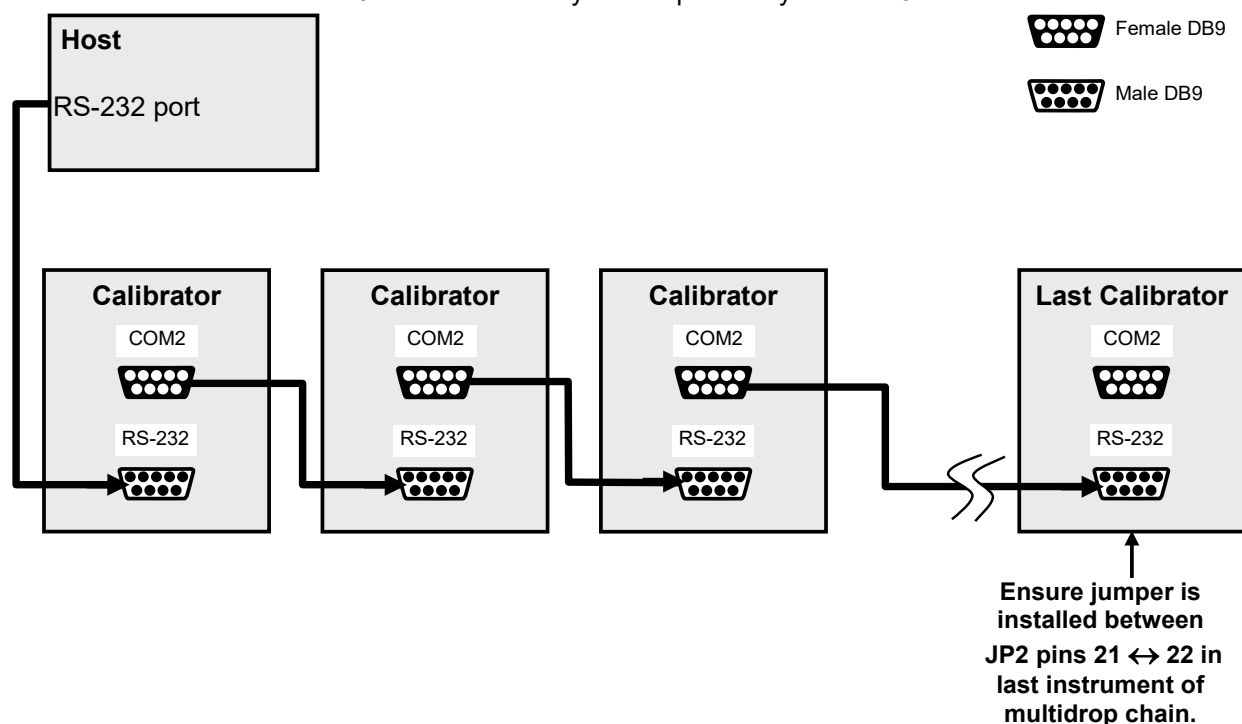

**Figure 2-12: RS-232-Multidrop PCA Host/Calibrator Interconnect Diagram**

7. BEFORE communicating from the host, power on the instruments and check that the Machine ID code is unique for each.
  - a. In the SETUP Mode menu go to SETUP>VARS>Instrument ID.
  - b. to change the identification number, select the VAR, press the Edit button and use the keypad to assign a new ID
  - c. Press/select ENTER to accept the new ID for that instrument.
8. Next, in the SETUP>MORE>COMM>COM1 menu (do not use the COM2 menu for multidrop), edit the COM1 MODE parameter as follows: press/select EDIT and set only QUIET MODE, COMPUTER MODE, and MULTIDROP MODE to ON. Do not change any other settings.
9. Press/select ENTER to accept the changed settings, and ensure that COM1 MODE now shows 35.
10. Press/select SET> to go to the COM1 BAUD RATE menu and ensure it reads the same for all instruments (edit as needed so that all instruments are set at the same baud rate).

**Note**

**The (communication) Host instrument can address only one instrument at a time, each by its unique ID (see step 7 above).**

**Teledyne API recommends setting up the first link, between the Host and the first calibrator, and testing it before setting up the rest of the chain.**

## RS-485 CONNECTION

As delivered from the factory, COM2 is configured for RS-232 communications. This port can be reconfigured for operation as a non-isolated, half-duplex RS-485 port. Using COM2 for RS-485 communication disables the USB port. To reconfigure this port for RS-485 communication, please contact the factory.

### 2.3.2. PNEUMATIC CONNECTIONS

#### CAUTION – RISK OF INHALATION AND ASPHYXIATION



Because this calibrator generates ozone (O<sub>3</sub>), it must be properly vented outside the room or enclosure. See Figure 2-13 and Section 2.3.2.3.

#### CAUTION – Avoid Damage to the Instrument



Do not operate this instrument without first removing dust plugs from inlet and outlet/exhaust ports!.

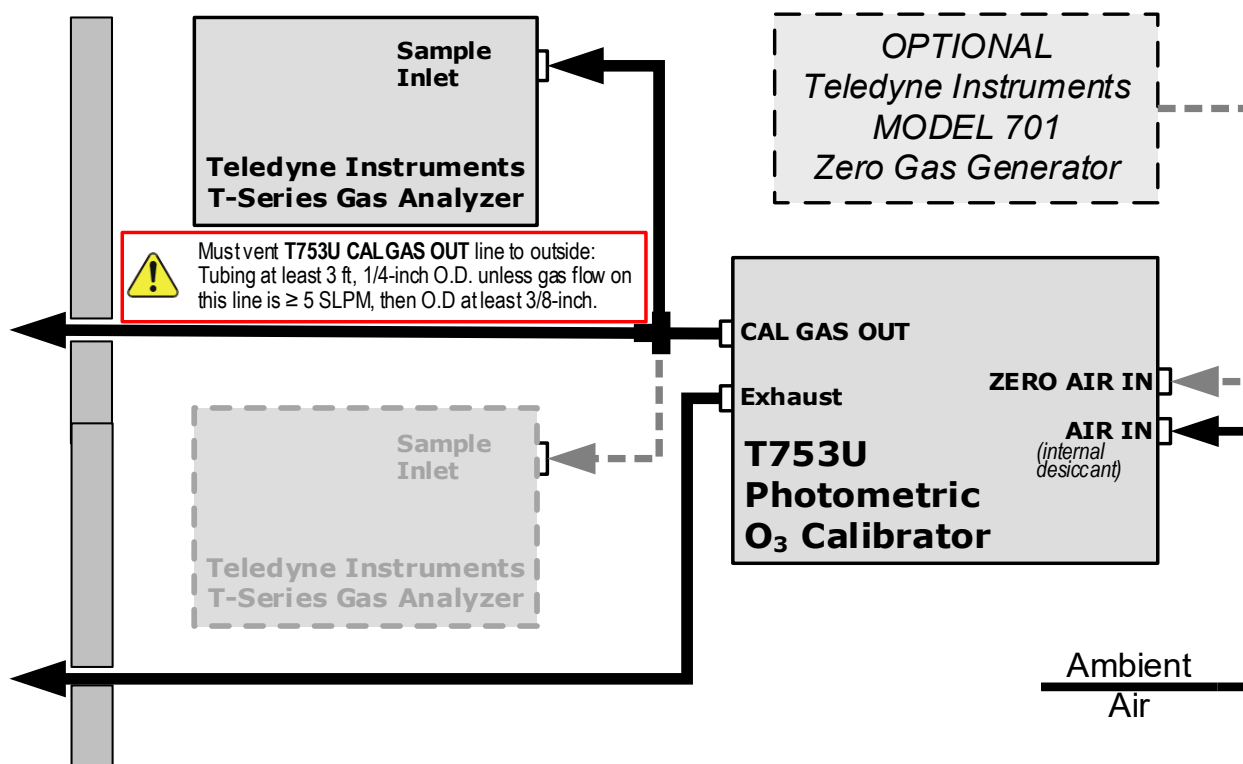

Figure 2-13: Basic Pneumatic Setup

#### 2.3.2.1. Dry Air In

When using the internal zero air pump option, a canister of silica gel is in place which will serve as the source of dry air; the DRY AIR IN port should be open to ambient air. With this option, set the ZA Pump Enable Var to ON (Configure in Setup>Vars). See Section 7.6 for more information regarding the silica gel.

### 2.3.2.2. Zero Air In



#### CAUTION – Avoid Damage to the Instrument

**Zero Air In port must be capped when not connected to external zero air source.**

An external pressurized source of zero air can be supplied at the ZERO AIR IN port. This is the standard configuration when the internal zero air pump is not installed. This zero air should be scrubbed of ozone and have a dew point of -20 °C or less. The pressure of the zero air should be regulated to 20-35 psig.

#### Note

**When connecting an external source of zero air to the T753U with an internal zero air pump installed, the zero air pump should be disabled.**

**The ZA Pump Enable VAR (Setup>Vars) should be set to OFF.**

### 2.3.2.3. Cal Gas Out

The CAL GAS OUT port has specific venting requirements as the T753U does not have an external vent; it can be connected to a two-port manifold going to a single analyzer or a three-port manifold going to two analyzers, with the extra port being vented to outside the room. The vent tubing must be no shorter than 3 feet in length with 1/4-inch O.D. unless the flow on this line is  $\geq 5$  SLPM, in which case the tubing must be 3/8-inch O.D.

Sample lines for ozone instruments to be calibrated can be connected directly to this manifold.

To prevent ozone exposure, the bottom port of this manifold is used as a vent and should be connected to a proper unpressurized vent manifold. It is important that the backpressure at this vent fitting be kept to a minimum. If a vent line longer than 2 meters (~6 feet) is required, then 3/8" OD tubing should be used.

### 2.3.2.4. Exhaust



#### CAUTION – ASPHYXIATION HAZARD

**Exhaust gas must be vented properly.**

Vent the EXHAUST port outside the enclosed area or to an unpressurized vent manifold to prevent ozone exposure.

## 2.4. INITIAL STARTUP

If you are unfamiliar with the T753U principles of operation, we recommend that you read Section 9.

After making all of the electrical and pneumatic connections, turn on the instrument; a sequence of status screens (Figure 2-14) appear on the display screen, followed by the Home page (Figure 2-15) with the calibrator in **STANDBY** mode after completing the boot-up sequence.

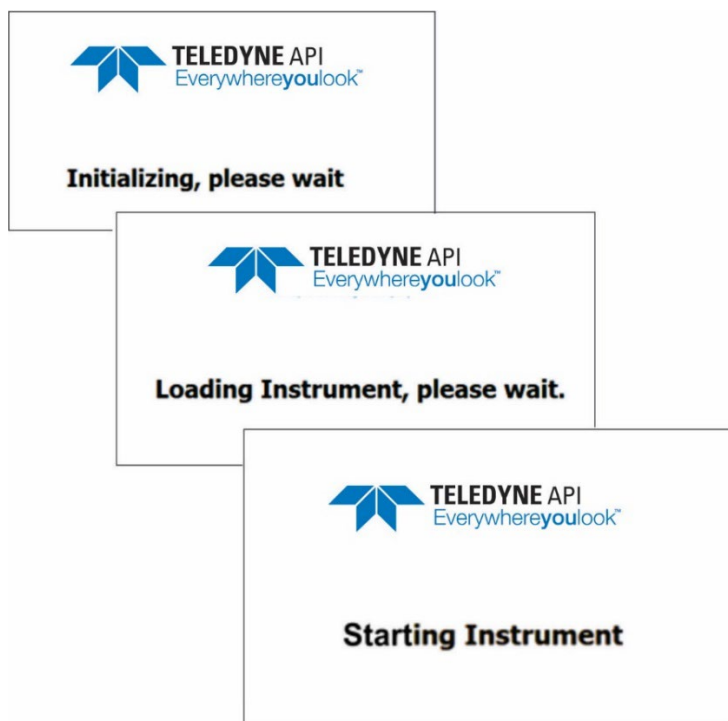

Figure 2-14: Status Screens at Startup

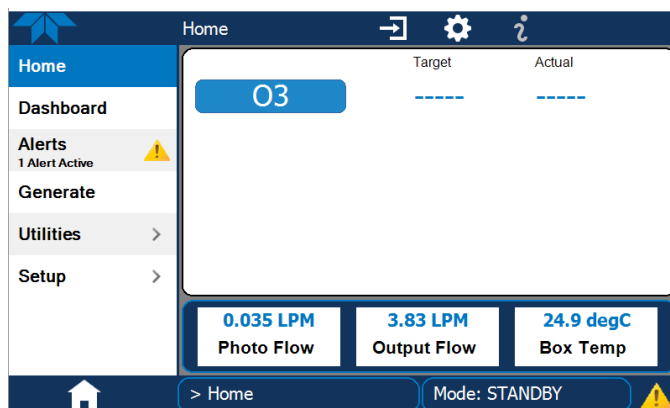

Figure 2-15: Initial Home Page (in Standby Mode)

The T753U Portable Calibrator requires several-to-30 minutes for all of its internal components to reach a stable operating temperature, during which time most warnings and other messages, called Alerts, will be suppressed.

### 2.4.1. ALERTS: WARNINGS AND OTHER MESSAGES

The Alerts page (Figure 2-16) shows the status of any active warning conditions or user-configured Events. (Section 3.2.3 provides more detailed information about Alerts, and Section 3.3.2 addresses Events).

Alerts can be viewed and cleared via either the Alerts menu or the Alerts shortcut (Caution symbol, bottom right corner of the screen). Although these alerts can be cleared from the Active Alerts page, a history of all alerts remains in the Utilities>Alerts Log page.

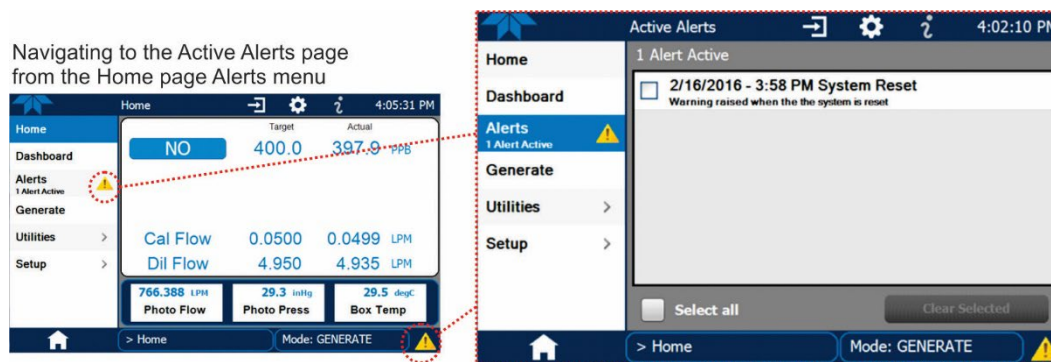

**Figure 2-16: Viewing Active Alerts Page**

(If alerts of warning conditions persist after the warm up period or after being cleared, investigate their cause using the troubleshooting guidelines in Section 8).

In the meantime, check the functionality of the instrument (Section 2.4.2).

### 2.4.2. FUNCTIONAL CHECKS

After warm-up, view the Dashboard page(s) (Figure 2-17) to check that the instrument is functioning within allowable operating parameters, the four most critical of which are:

- O3 Gen Lamp Temp: 48 °C (± 2 °C )
- Photo Lamp Temp: 58 °C (± 2°C )
- O3 Meas voltage (>4,000 mV)
- O3 Ref voltage (>4,000 mV)

These particular functions must stabilize to properly generate ozone. (If any functional parameters are not displayed, configure the Dashboard through the Setup>Dashboard menu to add them; see Section 3.3.3 for details).

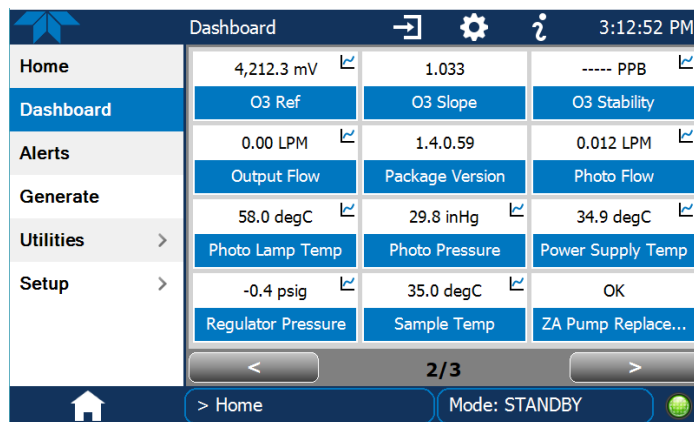

Figure 2-17: Sample Dashboard Page

### 2.4.3. START GENERATING

Once startup is initiated and functions are checked and working properly, the portable calibrator is ready to generate ozone at 5 LPM as set up at the factory:

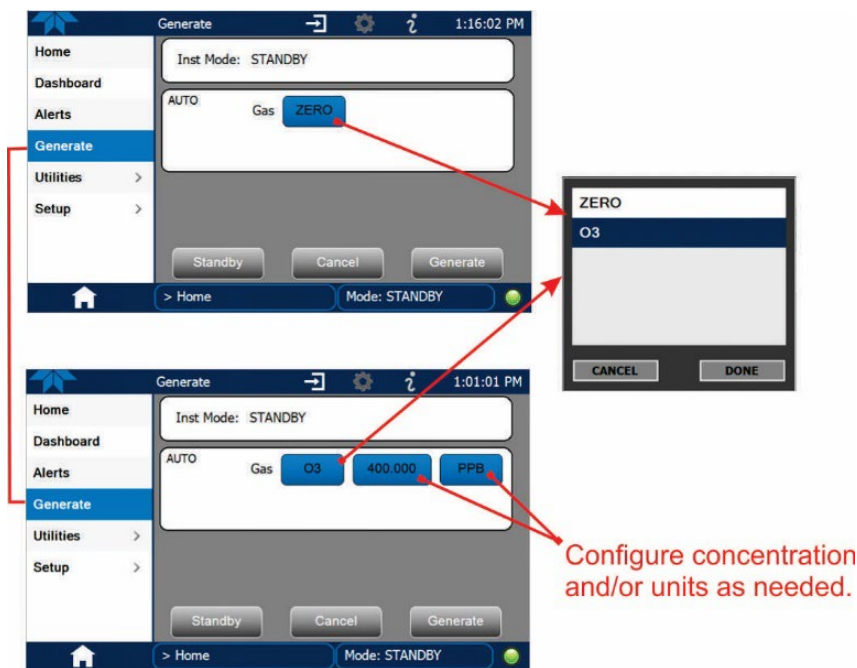

Figure 2-18: Basic Generate Initiation

If the calibrator’s application requires a different output flow, follow the procedures set forth in Section 4.4. Section 3 provides information on the menu system, including feature and function configurations, and additional operation instructions, including using the calibrator as an O<sub>3</sub> photometer, are presented in Section 4.



## 3. CONFIGURATION

This section first provides an overview of the menu (hierarchy with brief descriptions, Section 3.1), followed by an orientation to the main menu pages (Section 3.2), then configuration guidance in the Setup submenus (Section 3.3).

### 3.1. MENU OVERVIEW

Table 3-1 describes the menus and provides cross-references for expanded details.

**Table 3-1. Menu Overview**

| MENU             | DESCRIPTION                                                                                                                                                                                                                                                                                                                                                                                                           | LOCATION        |
|------------------|-----------------------------------------------------------------------------------------------------------------------------------------------------------------------------------------------------------------------------------------------------------------------------------------------------------------------------------------------------------------------------------------------------------------------|-----------------|
| <b>Home</b>      | View and plot concentration readings and selectable meter readings.                                                                                                                                                                                                                                                                                                                                                   | Section 3.2.1   |
| <b>Dashboard</b> | View user-selected parameters and their readings, some of which can be displayed in a live-plot graph.                                                                                                                                                                                                                                                                                                                | Section 3.2.2   |
| <b>Alerts</b>    | View and clear active Alerts that were triggered by factory-defined Events as well as user-defined Events. (Active and past Alerts are recorded in the Utilities>Alerts Log).                                                                                                                                                                                                                                         | Section 3.2.3   |
| <b>Generate</b>  | Generate calibration either ozone or zero; execute Sequences created in Setup>Sequences, and Levels created in Setup>Levels.                                                                                                                                                                                                                                                                                          | Section 3.2.4   |
| <b>Utilities</b> | View logs, download data and firmware updates, copy configurations between instruments, and run diagnostics.                                                                                                                                                                                                                                                                                                          | Section 3.2.5   |
| Datalog View     | Displays the data logs that were configured via the Setup>Data Logging menu. From this list a log can be selected and filters applied to view the desired data, which is downloadable through the Utilities>USB Utilities page.                                                                                                                                                                                       | Section 3.2.5.1 |
| Alerts Log       | Displays a history of Alert messages triggered by factory-defined and user-defined Events, such as warnings and alarms (See Section 3.3.2 for Events configuration).                                                                                                                                                                                                                                                  | Section 3.2.5.2 |
| USB Utilities    | Serves multiple purposes using a flash drive connected to the instrument's front panel USB port: <ul style="list-style-type: none"> <li>download data from instrument's Data Acquisition System (DAS), the Data Logger, to a flash drive (Section 3.2.5.3)</li> <li>update firmware (Section 7.2)</li> <li>transfer instrument configuration from/to other instruments of the same model (Section 3.2.5.3)</li> </ul> | Section 3.2.5.3 |
| Diagnostics      | Provides access to various pages that facilitate troubleshooting.                                                                                                                                                                                                                                                                                                                                                     | (various)       |
| Analog Inputs    | This page shows voltage signals of several analog input parameters, including those from other instrumentation when the External Analog Inputs Option is installed.                                                                                                                                                                                                                                                   | Section 8.1.3   |
| Analog Outputs   | Shows voltage signals for one parameter (configured through Setup>Analog Outputs, Section 3.3.9).                                                                                                                                                                                                                                                                                                                     | Section 8.2     |
| Digital Inputs   | Shows whether specific available Signal In features are active (ON) or inactive (OFF).                                                                                                                                                                                                                                                                                                                                | Section 2.3.1.4 |
| Digital Outputs  | Activate (ON)/deactivate (OFF) user-specified Signal Out features (configured in the Setup>Digital Outputs menu, Section 3.3.6).                                                                                                                                                                                                                                                                                      | Section 8.1.3   |
| Photo Flow Cal   | Calibrate photometer LPM flow.                                                                                                                                                                                                                                                                                                                                                                                        | Section 6.4     |
| Output Flow Cal  | Calibrate the output LPM flow.                                                                                                                                                                                                                                                                                                                                                                                        | Section 6.4     |

| MENU                       | DESCRIPTION                                                                                                                                                                                                                                                                                                                                                        | LOCATION                  |
|----------------------------|--------------------------------------------------------------------------------------------------------------------------------------------------------------------------------------------------------------------------------------------------------------------------------------------------------------------------------------------------------------------|---------------------------|
| O3 Gen Cal                 | Calibrate the ozone generator for concentrations above 50 PPB                                                                                                                                                                                                                                                                                                      | Section 6.2               |
| O3 Gen Frac Cal            | Calibrate the ozone generator for concentrations up to 50 PPB                                                                                                                                                                                                                                                                                                      | Section 6.2               |
| Back Pressure Compensation | Calibrate to compensate any impact on the internal measure/reference pressure.                                                                                                                                                                                                                                                                                     | Section 6.1.4             |
| Bench Cal                  | Calibrate the photometer bench with zero/span                                                                                                                                                                                                                                                                                                                      | Sections 6.1.3.1, 6.1.3.2 |
| Pressure Cal               | Calibrate ozone, regulator, and photometer pressures.                                                                                                                                                                                                                                                                                                              | Section 6.3               |
| <b>Setup</b>               | Configure a variety of features and functions through these submenus for customized operation.                                                                                                                                                                                                                                                                     | Section 3.3               |
| Datalogging                | Track and record concentration and calibration data and selectable diagnostic parameters, the reports for which can be viewed in the Utilities>Datalog View menu and downloaded to a flash drive via the Utilities>USB Utilities menu (Section 3.2.5.3). Also, select configured Events (Section 3.3.2) and create customized triggers for data logging functions. | Section 3.3.1             |
| Events                     | Select parameters and define the conditions by which they are to be flagged and recorded in the Alerts log (Section 3.2.5.2) when they are triggered.                                                                                                                                                                                                              | Section 3.3.2             |
| Dashboard                  | Monitor instrument functionality (Section 3.2.2) via selectable parameters.                                                                                                                                                                                                                                                                                        | Section 3.3.3             |
| Vars                       | Manually adjust several software variables that define specific operational parameters.                                                                                                                                                                                                                                                                            | Section 3.3.4             |
| Homescreen                 | Configure the parameters to be displayed in the three meters (Section 3.2.1 and Figure 2-15) along the bottom of the display.                                                                                                                                                                                                                                      | Section 3.3.5             |
| Digital Outputs            | Map the rear-panel digital outputs (labeled STATUS) to a variety of signals present in the instrument to monitor the status of operating conditions, or custom Events. (See Setup>Events).                                                                                                                                                                         | Section 3.3.6             |
| Sequences                  | Create new or edit existing executable calibration sequences and the steps within the sequences.                                                                                                                                                                                                                                                                   | Section 3.3.7             |
| Levels                     | Create individual flow and concentration outputs for LEADS.                                                                                                                                                                                                                                                                                                        | Section 3.3.8             |
| Analog Outputs             | Send user-selected parameter readings in the form of user-defined voltage or current loop signals as outputs to a strip chart recorder and/or the data logger.                                                                                                                                                                                                     | Section 3.3.9             |
| Instrument                 | View product and system information, including list of options, if any; view network settings; view/adjust Date and Time settings; and check for firmware updates when connected to a network that is connected to the Internet.                                                                                                                                   | Section 3.3.10.1          |
| Comm                       | View and configure network and serial communications.                                                                                                                                                                                                                                                                                                              | Section 3.3.11            |

### 3.2. MAIN MENU PAGES

This section describes the pages of the main menu: Home, Dashboard, Alerts, Generate, and Utilities, and drills into further descriptions of the Utilities submenus. The Setup menu warrants a section of its own (Section 3.3) with instructions for configuring the various features and functions of the calibrator.

#### 3.2.1. HOME

Figure 3-1 shows the features of the main interface from the Home page. The meters at the bottom of the display are user-selectable (see Section 3.3.5).

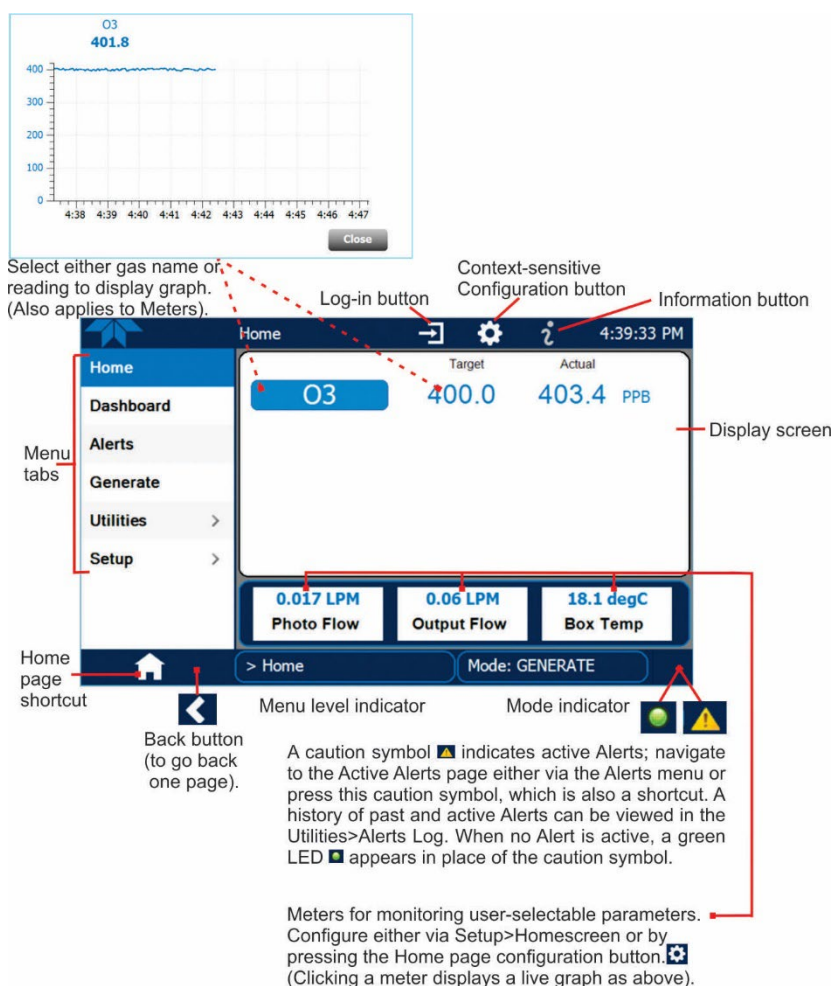

Figure 3-1: User Interface Orientation

**Note** The last page on display prior to drilling into a menu remains on display until a choice in the menu is selected.

### 3.2.2. DASHBOARD

The dashboard displays an array of user-selected parameters and their values (Figure 3-2). If there is a graphing icon in the upper right corner of a parameter, pressing that parameter displays a live plot of its readings, as in Figure 3-3. Depending on the number of available parameters selected, the Dashboard can have more than one page. See Section 3.3.3. for configuration details.

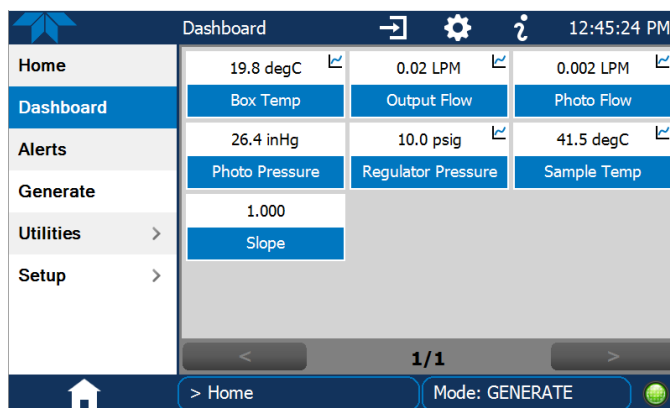

Figure 3-2: Dashboard Page

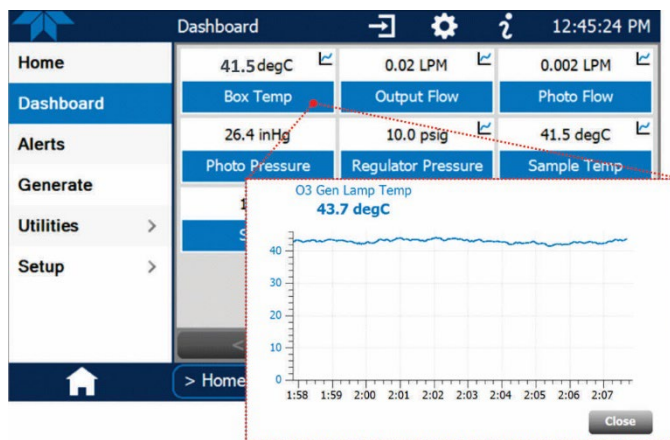

Figure 3-3: Viewing a Live Plot from Dashboard Page

Three of the dashboard parameters can be set up for continuous display as meters located below the concentration display of the Home page through the Setup>Homescreen menu (Section 3.3.5).

### 3.2.3. ALERTS

Alerts are notifications triggered by specific criteria having been met by either factory-defined conditions (standard and not editable) or user-defined Events (Section 3.3.2). The Active Alerts page shows the status of any active warning conditions or Events that have been triggered.

When Alerts are triggered, a caution symbol appears in both the Alerts menu tab and in the bottom right corner of the software interface, which serves as a shortcut to the Alerts page from any other page. View a list of currently active Alerts by pressing either the Alerts menu on the Home screen or by pressing the Alerts shortcut (Figure 3-4).

While Alerts can be cleared from the Active Alerts page, they remain recorded in the Utilities>Alerts Log. To configure Events, see Section 3.3.2.

Navigate to the Active Alerts page via the Alerts menu on Home screen.

(Also view a list of all active and past Alerts and Events via Utilities>Alerts Log).

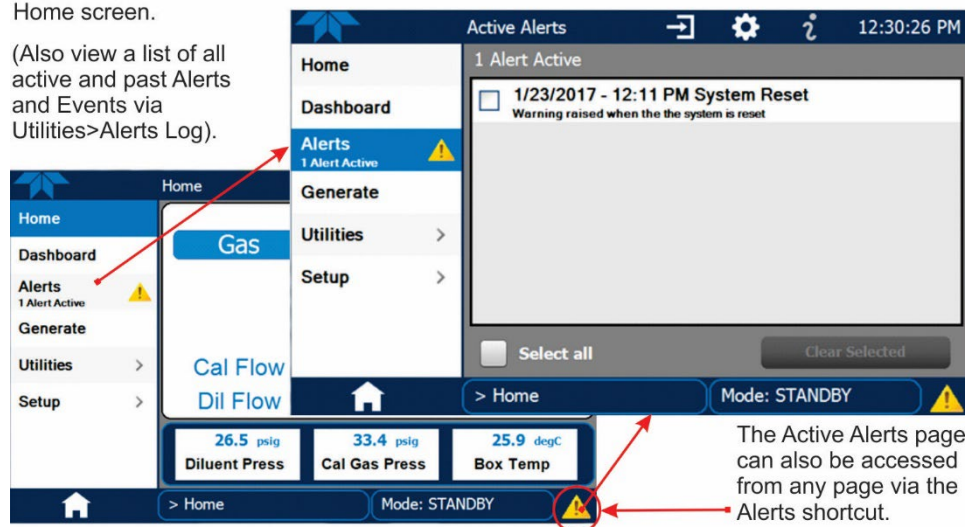

**Figure 3-4: Navigating to the Active Alerts Page**

Alerts appear as either latching or non-latching:

- Latching: displayed in Active Alerts screen when an Event is triggered and must be cleared by the user).
- Non-latching: (Active Alerts screen continuously updates based on the Event criteria, clearing on its own).

To clear Alerts from the Active Alerts page, either check individual boxes to choose specific Alerts, or check the Select All box to choose all Alerts, then press the Clear Selected button.

When all Alerts are cleared, the Alerts menu tab no longer shows the caution symbol, and a green LED replaces the caution symbol in the bottom right corner of the interface (Figure 3-5). However, Alerts can reappear if the conditions causing them are not resolved. For troubleshooting guidance, refer to the instrument's user manual.

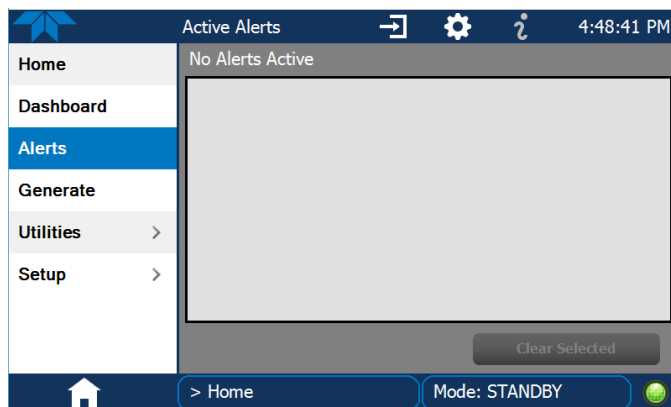

**Figure 3-5: Active Alerts Cleared**

### 3.2.4. GENERATE

The Generate menu provides the ability to:

- Generate either ozone or zero air
- Execute a Sequence (configured in the Setup menu)
- Execute a Level (configured in the Setup menu)
- Place the instrument into Standby mode (suspend generating gas)

Using the Generate menu is presented in Section 4. To configure Sequences, see Section 3.3.7 or to configure Levels, see Section 3.3.8

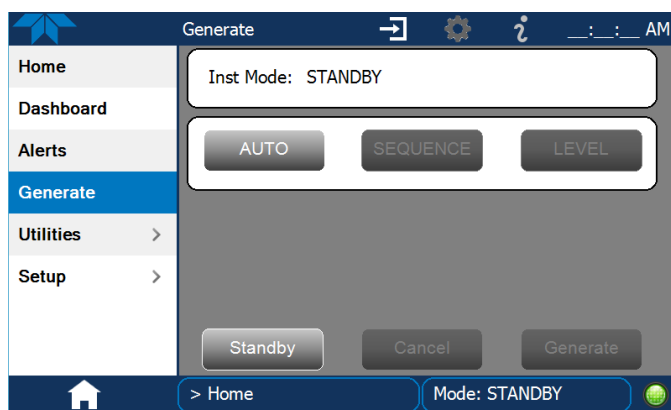

**Figure 3-6: Generate Page**

### 3.2.5. UTILITIES

The Utilities menu opens to the Datalog View, the Alerts Log, the USB Utilities, and the Diagnostics submenus.

#### 3.2.5.1. Datalog View

The Datalog View tab displays a list of data logs that were configured in the Setup>Data Logging menu (Section 3.3.1). From this list a log can be selected and filters applied to view the desired data.

#### 3.2.5.2. Alerts Log

The Alerts Log holds a history of alerts that were triggered by factory-defined and user-defined Events, such as warnings and alarms.

#### 3.2.5.3. USB Utilities (Downloads and Updates)

The USB Utility page serves multiple purposes using a flash drive connected to the instrument's front panel USB port:

- downloading Data Acquisition System (DAS) data from the instrument to a flash drive (presented below).
- updating firmware (presented below and in Section 7.3).
- copying a configuration from one instrument to other same-model instruments (presented below).
- downloading a basic operation functionality report (presented below and in Section 7.2)

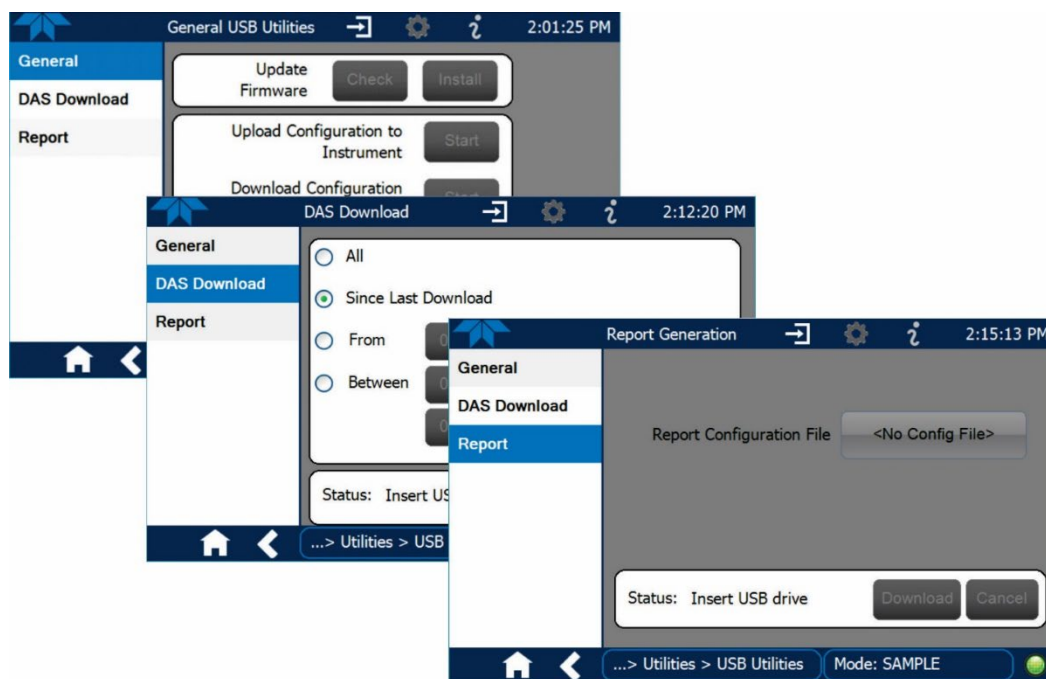

**Figure 3-7: USB Utilities Pages**

The Status field shows when an inserted flash drive has been detected, at which time firmware updates, configuration copying and DAS downloading can be carried out.

### DOWNLOADING DAS (DATA ACQUISITION SYSTEM) DATA

DAS data (collected by the Datalogger, Section 3.3.1) can be downloaded from the instrument to a flash drive through the Utilities>USB Utilities>DAS Download menu, as follows:

1. Insert a flash drive into a front panel USB port and wait for the Status field to indicate that the drive has been detected; available buttons will be enabled.

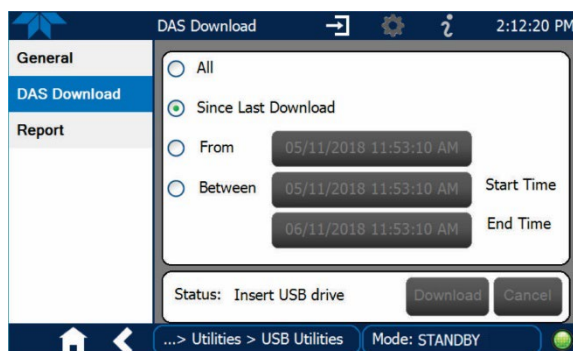

**Figure 3-8: Das download Page**

2. To copy the data to the flash drive, press the Start button next to “Download DAS Data from Instrument.” (The Cancel button will be enabled).
3. When complete, as indicated in the Status field, the Cancel button becomes the Done button; press Done and then remove the flash drive.

### UPDATING FIRMWARE

It is possible to check for firmware updates, reload current firmware, and to update firmware remotely. Because this is a maintenance item and there is more than one way to implement an update, instructions are provided in Section 7.3.

### TRANSFERRING CONFIGURATION TO OTHER INSTRUMENTS

Once an instrument is configured, the same configuration can be copied to other instruments of the same Model. This encompasses essentially anything the user can configure and does not apply to instrument-specific settings such as those that are configured at the factory for calibration.

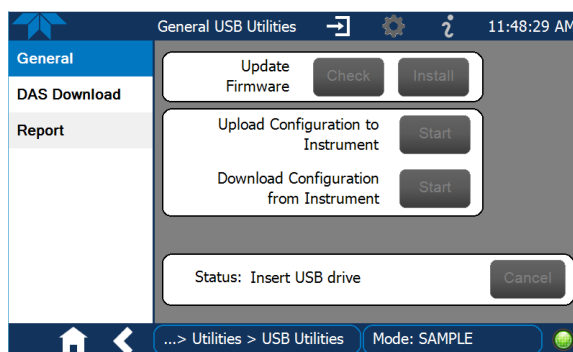

**Figure 3-9: Configuration Transfer**

1. In the source instrument, navigate to the Home>Utilities>USB Utilities>General page.
2. Insert a flash drive into either of the two front panel USB ports.



3. When the Status field indicates that the USB drive has been detected, press the “Download Configuration from Instrument” Start button.
4. When the Status field indicates that the download is complete, remove the flash drive.
5. In the target instrument, navigate to the Home>Utilities>USB Utilities>General page.
6. Insert a flash drive into either of the two front panel USB ports.
7. When the Status field indicates that the USB drive has been detected, press the “Upload Configuration to Instrument” Start button.

When the Status field indicates that the upload is complete, remove the flash drive.

## GENERATING A REPORT

The Report page is used typically for monitoring the functionality of the instrument. Because it is used in maintenance and troubleshooting, the Report feature is presented in Section 7.2.

### 3.2.5.4. Diagnostics

The Diagnostics menu provides access to several diagnostics submenus, which can be helpful in troubleshooting (Section 8). When an item in the menu is selected, the display shows its description. Table 3-1 on page 39 also provides descriptions.

**Note**

**Some Diagnostics items do not appear in the menu unless the instrument has been placed in Standby mode (Home>Generate menu).**

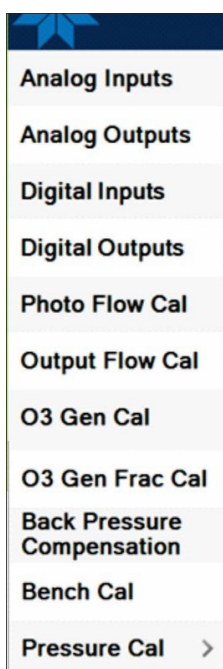

### 3.3. SETUP (CONFIGURING THE CALIBRATOR'S FEATURES/FUNCTIONS)

Use the Setup menu to configure the instrument's software features, to gather information on the instrument's performance, and to configure and access data from the Datalogger, the instrument's internal data acquisition system (DAS). Once the setups are complete, the saved configurations can be downloaded to a USB drive through the Utilities>USB Utilities menu and uploaded to other instruments of the same model.

#### 3.3.1. SETUP>DATA LOGGING

Set up the Data Logger to track and report instrument data based on user-configurable periodic timers or conditional triggers (presented next in this section) or Event-based triggers (Section 3.3.2). In the Home>Setup>Data Logging menu (Figure 3-10), press the ADD button to create a new log (Figure 3-11), or select an existing log from the Data Logging list and press the EDIT or DELETE button to make the desired changes).

Later, to transfer the captured (logged) from the instrument to a flash drive, use the Utilities>USB Utilities menu (refer to Section 3.2.5.3).

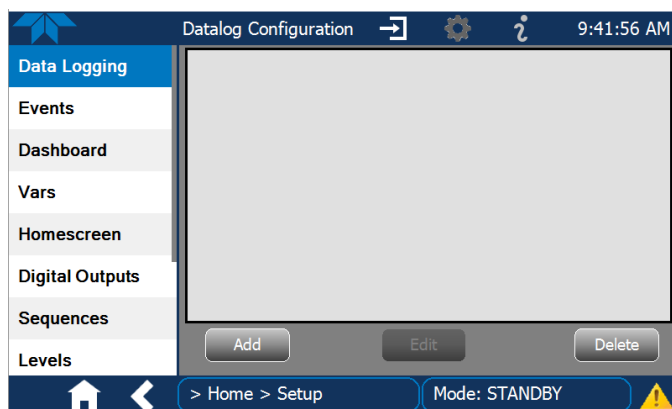

Figure 3-10: Setup>Data Logging Page

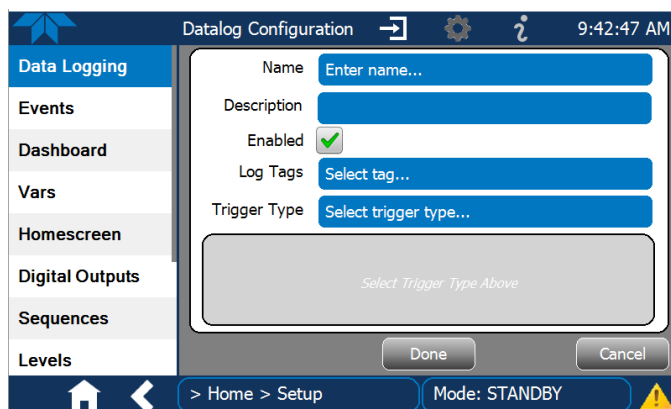

Figure 3-11: Datalog Configuration, New Log Page

### 3.3.1.1. Creating a User-Defined Data Log

The screenshot shows the 'Datalog Configuration' screen with a sidebar menu on the left containing 'Data Logging', 'Events', 'Dashboard', 'Vars', 'Homescreen', 'Digital Outputs', 'Sequences', and 'Levels'. The main configuration area includes fields for 'Name', 'Description', 'Enabled' (checked), 'Log Tags', and 'Trigger Type'. A keyboard pop-up is shown above the screen with red arrows pointing to the 'Name', 'Description', 'Log Tags', and 'Trigger Type' fields. Below the main screen, two callout boxes provide details for 'Periodic' and 'Conditional' trigger types.

Press the Name field and use the keyboard pop-up to label the new log.

Press the Description field and use the keyboard pop-up to describe the log.

Leave the Enabled box checked to allow data capture of this log, or press to uncheck and suspend data capture.

Press the Log Tag field to select one or more parameters for the new data log.

Press the Trigger Type field to select either Periodic or Conditional.

When **Periodic** is selected as the Trigger Type, the field below it is populated with the Interval/Date/Time window.

When **Conditional** is selected as the Trigger Type, the field below it is populated with the Trigger and Condition definition window.

(Please refer to the section on Configuring Trigger Types for details).

**Figure 3-12: Datalog Configuration**

### 3.3.1.2. Configuring Trigger Types for the Datalogger

#### PERIODIC TRIGGER

The Periodic trigger is a timer-based trigger that is used to log data at a specific time interval. Periodic Trigger requires an interval that is set to number of minutes and a start time that is set to date and time.

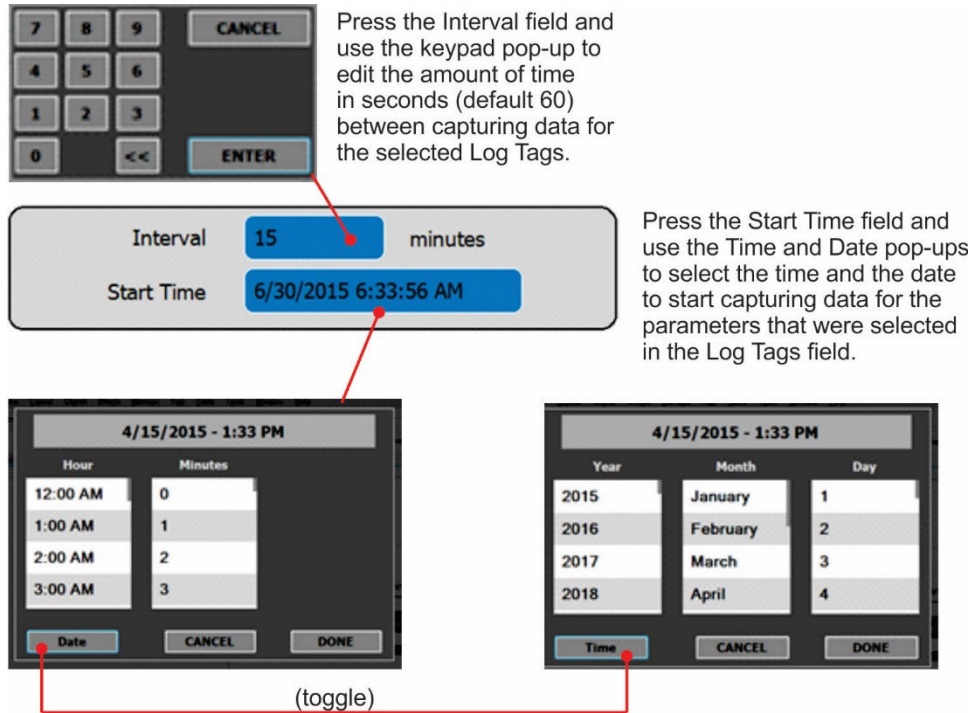

Figure 3-13: Datalog Periodic Trigger Configuration

#### CONDITIONAL TRIGGER

Conditional Trigger tracks/records data for user-selected parameters that meet specified conditions.

Press the Trigger Tag field and select a parameter to be tracked/logged. A default Condition associated with the selected Tag will populate the Condition field.

Press the Condition field to select a different choice from the condition list.

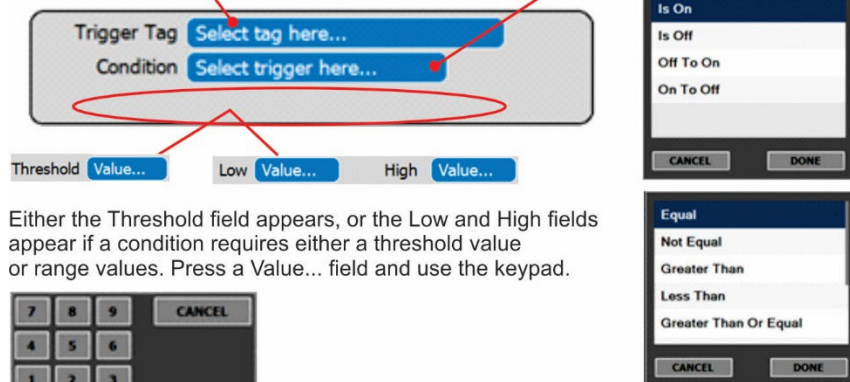

Figure 3-14: Datalog - Conditional Trigger Configuration

### 3.3.2. SETUP>EVENTS

Events are occurrences that relate to any operating function, and are used to define the conditions that will trigger Alerts (Section 3.2.3). Events can provide diagnostic information about the instrument, typically referred to as “Warnings”, or they can provide additional instrument functionality, such as concentration alarms. Some Events are standard and not editable while others are user-configurable, described here.

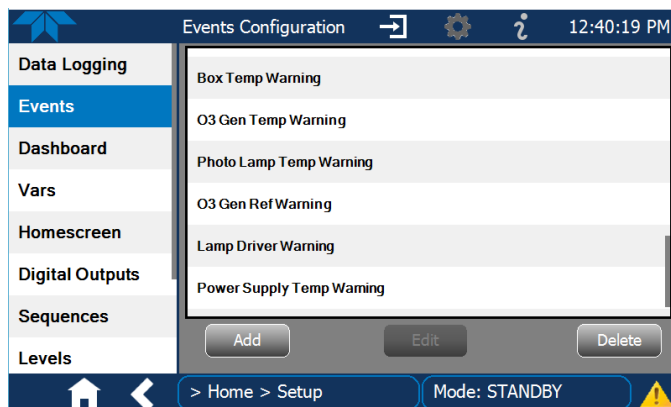

Figure 3-15: Events List

### 3.3.2.1. Creating User-defined Events

In the Home>Setup>Events menu (Figure 3-15) press ADD to create a new Event. Figure 3-16 depicts the steps for creating an Event. In the center of the display, the Enabled box allows the choice of whether to track and record the Event. The Visible box allows the choice of whether or not to display the Event in the Alerts tab when it is triggered, although it will still be recorded. The third box allows the choice of whether or not to make it a Latching Event.

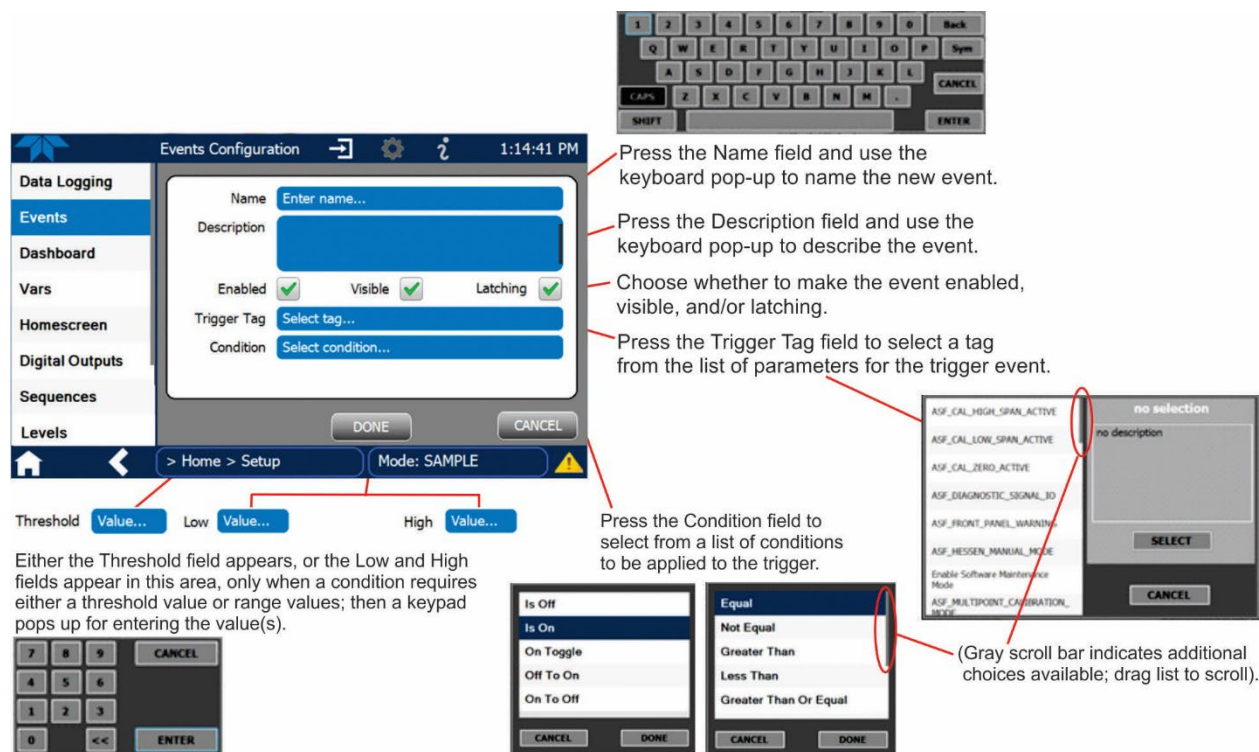

Figure 3-16: Event Configuration

### 3.3.2.2. Editing or Deleting Events

Select an Event from the list (Figure 3-15) and press the EDIT button to view or edit the details (Figure 3-17). Press/click the field(s) to edit. To delete an Event, select the Event from the list and press the DELETE button (shown in Figure 3-15).

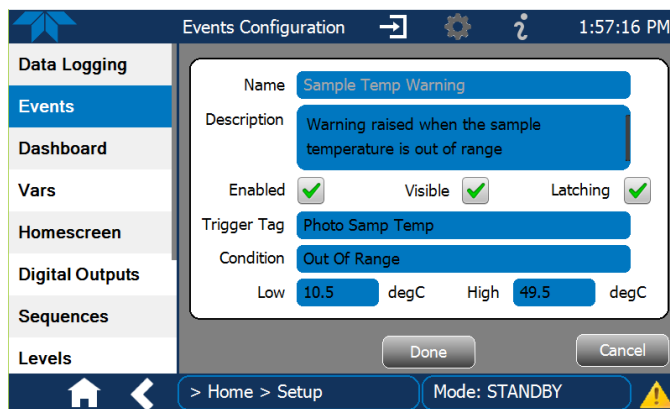



Figure 3-17: Existing Event for Viewing or Editing

### 3.3.3. SETUP>DASHBOARD

The Dashboard can be configured to display an array of parameters, and can extend to more than one Dashboard page.

- To add a parameter for display in the Dashboard, make a selection from the “Available Tags” column and press the right-pointing button .
- To remove a parameter from the Dashboard, select a tag from the “Dashboard” column and press the left-pointing button .

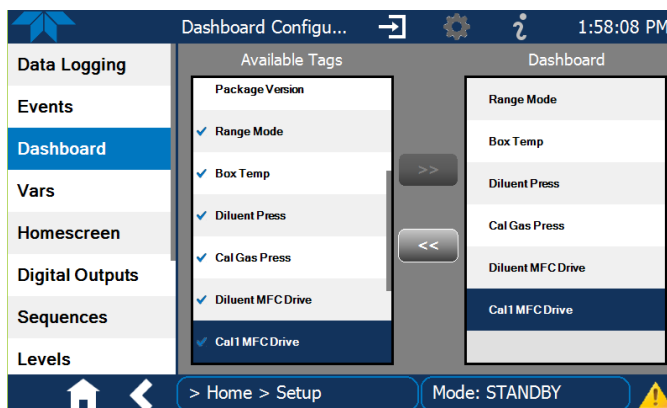



Figure 3-18: Dashboard Configuration Page through Setup Menu

The Dashboard Configuration page can also be reached by pressing the shortcut icon  while in the Dashboard page.

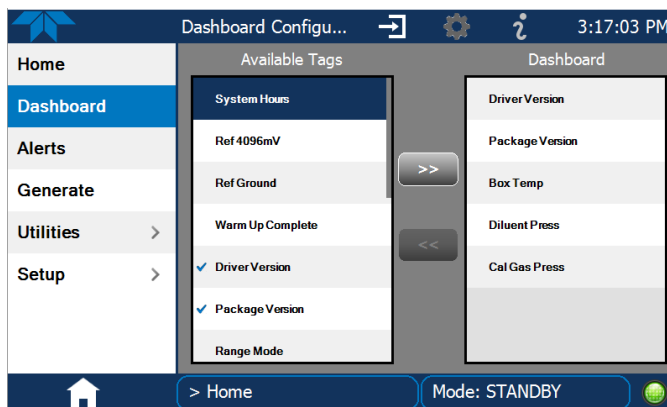

Figure 3-19: Dashboard Configuration Page through Dashboard Shortcut

### 3.3.4. SETUP>VARS (VARIABLES)

The T753U has several user-adjustable software variables, which define certain operational parameters. Select a Var to see a description of its purpose in the pane to the right; press the Edit button to change its setting(s).

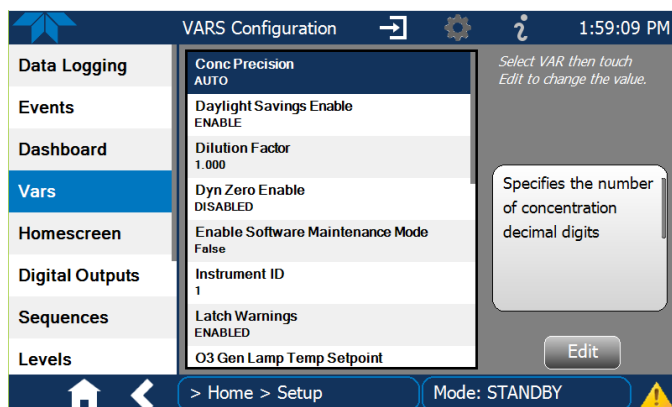

Figure 3-20: Vars Configuration Page

### 3.3.5. SETUP>HOMESCREEN

Configuring the Homescreen involves selecting a parameter to display in each of the three meters located below the concentration display. From the Setup>Homescreen menu scroll through the list of available tags and select one, then touch a meter to apply. Repeat for the other two meters.

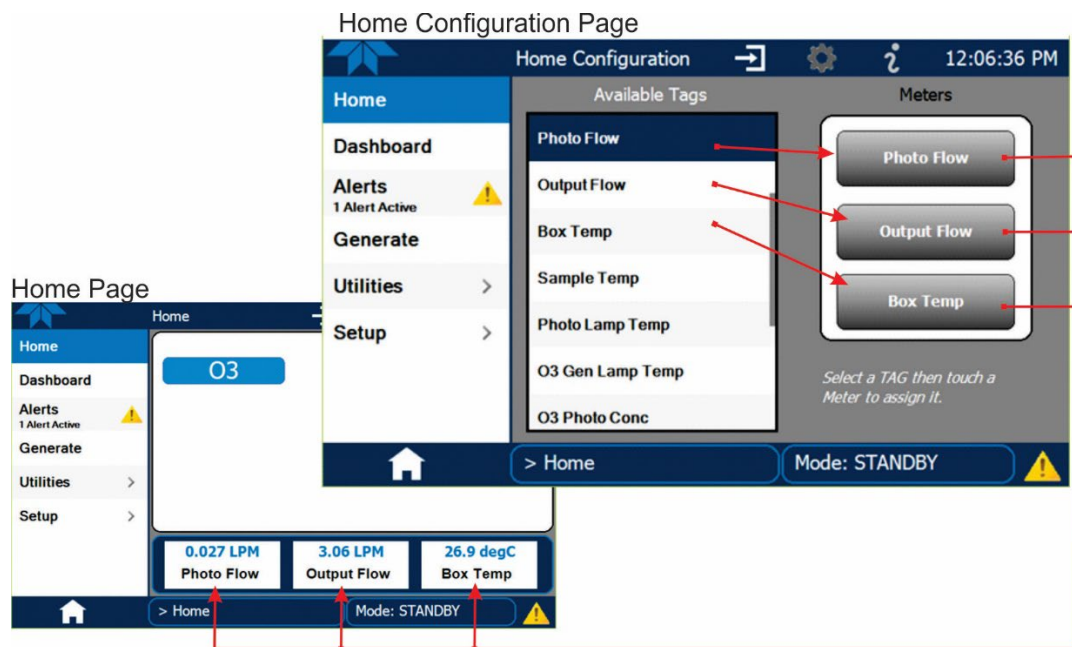

Figure 3-21: Home Configuration through Setup>Homescreen Menu

Home Configuration can also be reached by shortcut while in the Home page by pressing the context-sensitive configuration button  located at the top of the interface.



### 3.3.6. SETUP>DIGITAL OUTPUTS (STATUS)

Specify the function of each Digital Output for status and map it to any of a wide variety of “Signals” present in the instrument. The Digital Outputs 1 thru 8 correspond to pins 1 thru 8 on the rear panel STATUS connector. (MB Relay 1 thru 4 do not apply in the calibrator).

To map a status Digital Output to a Signal, select a pin in the Outputs list, then make a selection from the Signals list and press the Map button; if needed, change the polarity by pressing the Polarity button. Save any changes by pressing the Apply button or discard the changes by instead pressing the Home button (a pop-up provides a warning that the changes will be lost, and will prompt for confirmation to apply changes or not).

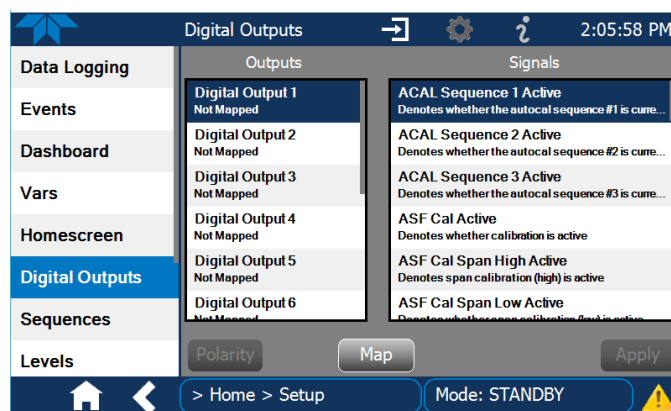

Figure 3-22: Digital Status Outputs Setup

### 3.3.7. SETUP>SEQUENCES

To configure automatic sequences of one or more multiple steps, use the Setup>Sequences menu (Figure 3-23) to create new sequences, edit existing sequences, and edit steps within a sequence. Each sequence is a database of single or multiple steps where each single step is an instruction that causes the instrument to perform an operation.

**Note**

**Last in = first out: the last step input into the program during configuration under “Edit Steps” is the first step executed, which means that multiple steps must be input in their reverse order; advanced planning is recommended.**

Refer to Figure 3-24 and Table 3-2 to configure sequences.

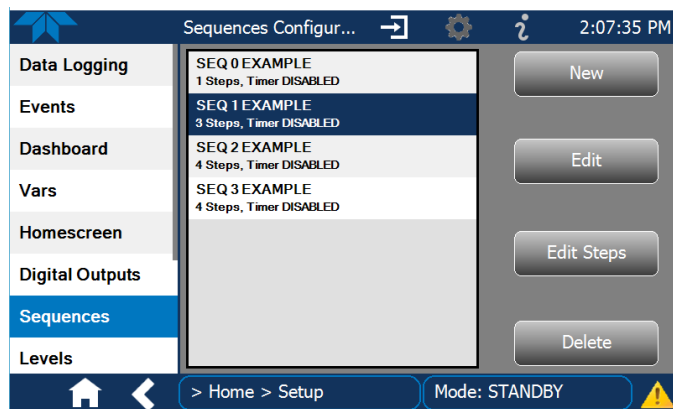

Figure 3-23: Example List of Configured Sequences

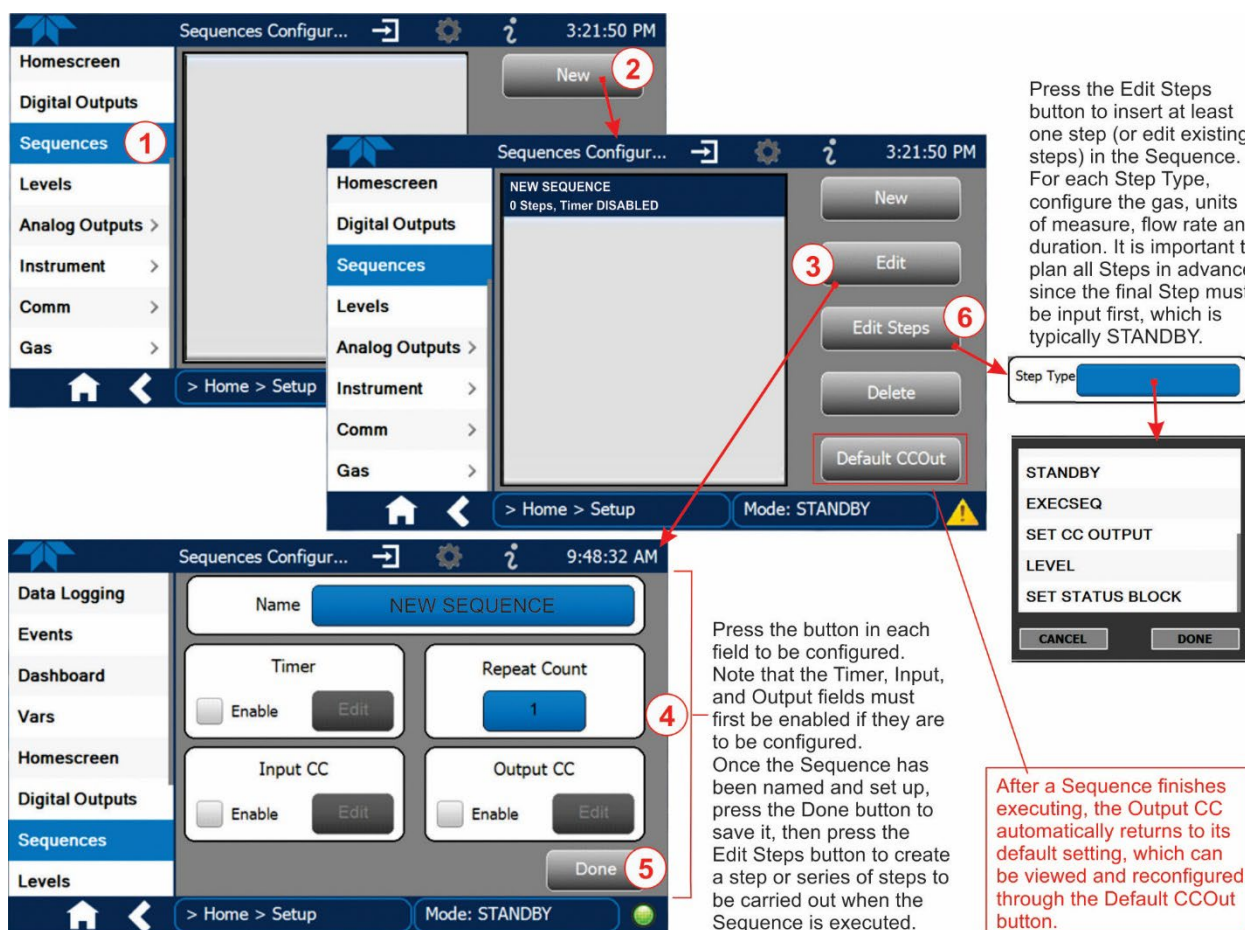

Figure 3-24: Configuring a Sequence

Sequences have several attributes and nested Steps that can be set up, as presented in Table 3-2.

Table 3-2: Automatic Calibration Sequence Set Up Attributes

| ATTRIBUTE           | DESCRIPTION                                                                                                                                                                                                                                                                                                                                                                                                                                                                                                                                                                                                                                                                                                                                                                                                                                                                                                                                                                                                                                                                                                                                                                                                                                                                                                                                    |                                                                                                                                                                                                        |
|---------------------|------------------------------------------------------------------------------------------------------------------------------------------------------------------------------------------------------------------------------------------------------------------------------------------------------------------------------------------------------------------------------------------------------------------------------------------------------------------------------------------------------------------------------------------------------------------------------------------------------------------------------------------------------------------------------------------------------------------------------------------------------------------------------------------------------------------------------------------------------------------------------------------------------------------------------------------------------------------------------------------------------------------------------------------------------------------------------------------------------------------------------------------------------------------------------------------------------------------------------------------------------------------------------------------------------------------------------------------------|--------------------------------------------------------------------------------------------------------------------------------------------------------------------------------------------------------|
| <b>Name</b>         | Allows the user to create a text string of up to 10 characters identifying the sequence.                                                                                                                                                                                                                                                                                                                                                                                                                                                                                                                                                                                                                                                                                                                                                                                                                                                                                                                                                                                                                                                                                                                                                                                                                                                       |                                                                                                                                                                                                        |
| <b>Timer Enable</b> | Check the Enable box to activate an internal automatic timer to initiate sequences using the calibrator's built in clock. The sequence can be set up to start at a predetermined date and time. Press the Edit button to configure the Timer.                                                                                                                                                                                                                                                                                                                                                                                                                                                                                                                                                                                                                                                                                                                                                                                                                                                                                                                                                                                                                                                                                                  |                                                                                                                                                                                                        |
|                     | Timer Start                                                                                                                                                                                                                                                                                                                                                                                                                                                                                                                                                                                                                                                                                                                                                                                                                                                                                                                                                                                                                                                                                                                                                                                                                                                                                                                                    | Edit this field to set the date and time to start running the sequence.                                                                                                                                |
|                     | Timer Delta                                                                                                                                                                                                                                                                                                                                                                                                                                                                                                                                                                                                                                                                                                                                                                                                                                                                                                                                                                                                                                                                                                                                                                                                                                                                                                                                    | Edit this field to set interval changes in days and/or hours and minutes, where the sequence repeats after the set delay time.                                                                         |
| <b>Repeat Count</b> | Number of times, between 0 and 100, to execute the same sequence. A value of 0 (zero) causes the sequence to execute indefinitely.                                                                                                                                                                                                                                                                                                                                                                                                                                                                                                                                                                                                                                                                                                                                                                                                                                                                                                                                                                                                                                                                                                                                                                                                             |                                                                                                                                                                                                        |
| <b>Input CC</b>     | Enable and edit this attribute to specify which of the Digital Control Inputs will initiate the sequence, allowing the entire sequence to be triggered from an external source, such as a data logger, where the calibrator operates in a slave mode.                                                                                                                                                                                                                                                                                                                                                                                                                                                                                                                                                                                                                                                                                                                                                                                                                                                                                                                                                                                                                                                                                          |                                                                                                                                                                                                        |
| <b>Output CC</b>    | <p>Enable and edit this attribute to allow the calibrator to control devices that accept logic-level digital inputs, such as programmable logic controllers (PLCs), data loggers, or digital relays/valve drivers. This instruction causes the sequence to set or reset the calibrator's digital control outputs. It is very useful in situations where the control outputs are being used to trigger other devices that need to be turned off and on in synch with the operation of the calibrator as it progress through the sequence. The CC Outputs can be used as:</p> <ul style="list-style-type: none"> <li>• 12 separate ON/OFF switches assigned to separate calibration sequences, or;</li> <li>• A 12-bit wide bus allowing the user to define activation codes for up to 4095 separate calibration sequences.</li> </ul> <p>Specify which of the 12 Digital Control Outputs will be active when the sequence is operating, or specify which ones to activate/deactivate while running individual steps within a calibration sequence.</p> <p><b>NOTE:</b> once a sequence is finished executing, the Output CC will continue running in its default configuration as set up through the Default CCOut button of the Setup&gt;Sequence page; it is recommended that the Default CCOut configuration be viewed/edited as needed.</p> |                                                                                                                                                                                                        |
| <b>Steps</b>        | <p>Steps are the actions that the Sequence is to execute. <b>NOTE:</b> the first step input in the Edit Steps page will be the last step executed by the Sequence. (In other words the Steps must be input in reverse order so that the first step displays at the top). In addition, it is strongly recommended that each Sequence end with an instruction to return the instrument to Standby mode; therefore, the STANDBY step should be the first Step that is input. Existing steps can be changed (Edit) or permanently removed (Delete). Press the Done button to accept the Steps and return to the Sequence list. The Step Types include:</p>                                                                                                                                                                                                                                                                                                                                                                                                                                                                                                                                                                                                                                                                                         |                                                                                                                                                                                                        |
|                     | <b>GENERATE</b>                                                                                                                                                                                                                                                                                                                                                                                                                                                                                                                                                                                                                                                                                                                                                                                                                                                                                                                                                                                                                                                                                                                                                                                                                                                                                                                                | Puts the instrument into <b>GENERATE</b> mode. Similar in operation and effect to the <b>GENERATE &gt; AUTO</b> function used at the Input and Control Panel.                                          |
|                     | <b>STANDBY</b>                                                                                                                                                                                                                                                                                                                                                                                                                                                                                                                                                                                                                                                                                                                                                                                                                                                                                                                                                                                                                                                                                                                                                                                                                                                                                                                                 | Stops generating and ends the sequence. It is strongly recommended to always insert this as a last step of the Sequence.                                                                               |
|                     | <b>EXECSEQ</b>                                                                                                                                                                                                                                                                                                                                                                                                                                                                                                                                                                                                                                                                                                                                                                                                                                                                                                                                                                                                                                                                                                                                                                                                                                                                                                                                 | Calls a previously configured sequence to be executed at this time. The calling sequence will resume running when the called sequence is completed. Program a maximum of 5 levels of nested sequences. |
|                     | <b>SET CC OUTPUT</b>                                                                                                                                                                                                                                                                                                                                                                                                                                                                                                                                                                                                                                                                                                                                                                                                                                                                                                                                                                                                                                                                                                                                                                                                                                                                                                                           | Allows the sequence to activate the digital control outputs. Similar to the OUTPUT CC attribute, but can be set and reset by individual steps.                                                         |
|                     | <b>LEVEL</b>                                                                                                                                                                                                                                                                                                                                                                                                                                                                                                                                                                                                                                                                                                                                                                                                                                                                                                                                                                                                                                                                                                                                                                                                                                                                                                                                   | Like EXECSEQ, this step type executes a Level (Section 3.3.8).                                                                                                                                         |

| ATTRIBUTE | DESCRIPTION             |                                                                                                                                                                                                                                                                                                                                                                                 |
|-----------|-------------------------|---------------------------------------------------------------------------------------------------------------------------------------------------------------------------------------------------------------------------------------------------------------------------------------------------------------------------------------------------------------------------------|
|           | <b>SET STATUS BLOCK</b> | <p>Enable1 is for Status Block 1, which corresponds to the physical CONTROL OUTPUT connector. To configure, press the respective Enable box and check the desired box(es) whose numbers correspond to the Pin numbers.</p> <p>Enable 2 is for Status Block 2, which does not correspond to any physical output but is used to communicate status over the serial data port.</p> |

### 3.3.7.1. Editing/Deleting Sequences

To edit an existing Sequence, navigate to the Setup> Sequences menu, select a Sequence and press either the Edit button or the Edit Steps button and make the changes.

To delete an existing Sequence, navigate to the Setup> Sequences menu, select a Sequence and press the Delete button.

Refer to Figure 3-24 to edit or delete sequences.

### 3.3.7.2. Activating Sequences

See Section 4.1 for methods of activating sequences.

### 3.3.8. SETUP>LEVELS

When the calibrator is equipped with a version of firmware that includes support for LEADS, there are a few parameters that can be programmed to carry out a single-step operation called a Level, starting with assigning a number (ID) to identify it. Unlike Sequences, Levels are not time based and do not include characteristics such as start time or duration; therefore a single LEVEL cannot switch between different concentration levels. Separate concentration outputs must be programmed into separate LEVELs. Up to twenty Levels can be programmed, using a range of ID numbers from 0-98; ID 99 is reserved for “Standby” (Refer to Section 4.2 for information about LEADS).

To program a Level, use the following instructions and refer to Figure 3-25:

1. With the instrument in Standby mode (Generate>Standby), go to the Setup>Levels menu.
2. Click the “New” button in the Levels Configuration page (default level ID is “0”, and the default Action is “Generate”).
3. Use the Edit button to start programming the new Level.
4. Use the Level field to assign a different ID (numeric keypad pops up).
5. In the Action field press the GENERATE button to bring up the next screen for selecting a gas.
6. Press the Gas button to select either ZERO or O3. (The Step Type field has only one choice). If selecting O3, edit the target concentration and units as needed, and press DONE

7. To configure one or both of two Status output blocks, click the respective Enable checkbox, then press the Edit button:
  - Status Block1: This block corresponds to the physical CONTROL OUTPUT connector.
  - Status Block2: The second status block does not correspond to any physical output but is used to communicate status over the serial data port.
8. Press the Done button to complete the programming for the individual Level.



Figure 3-25: Levels Programming and Editing

### 3.3.8.1. Editing/Deleting Levels

To edit an existing Level, navigate to the Setup>Levels menu, select a Level and start with Step 3 above.

To delete an existing Level, navigate to the Setup>Levels menu, select a Level and press the Delete button.

### 3.3.8.2. Activating Levels

See Section 4.2 for methods of activating Levels.

### 3.3.9. SETUP>ANALOG OUTPUTS

The Setup>Analog Outputs menu provides the ability to configure and calibrate the analog output that was connected per Section 2.3.1.2. It can set by the user to carry the signal level of any one of the parameters listed in the setup>Analog Outputs>Analog Output Cfg menu and will output an analog VDC signal that rises and falls in relationship to the value of that parameter.

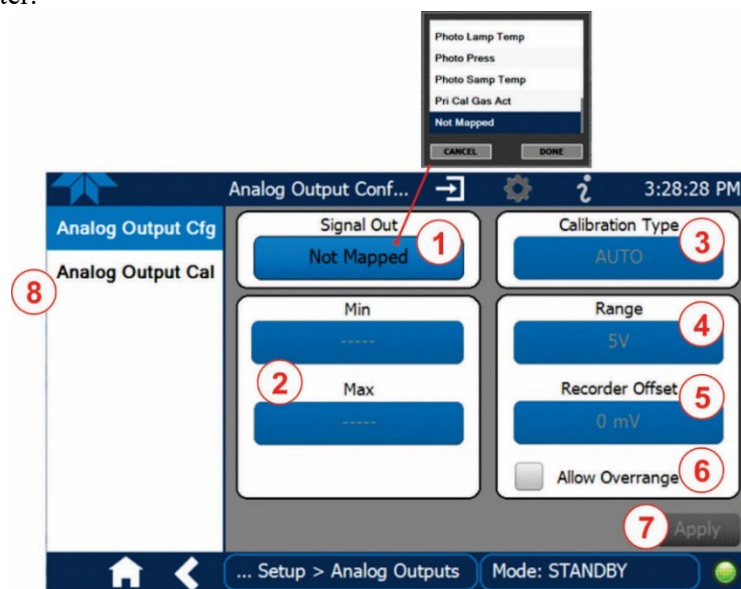

**Figure 3-26: Analog Output Configuration**

1. In the Setup>Analog Outputs>Analog Output Cfg> menu press the button in the Signal Out field and select a function from the pop-up list. (Select “Not Mapped” when calibrator not connected to an external recording device; this disables all other fields in the Analog Output Configurator).
2. In the Min Max fields input the minimum and maximum values for the parameter being configured, e.g., voltage range, Subsection 3.3.9.1).
3. In the Calibration Type field, select either AUTO or MANUAL..
  - AUTO sets the software to automatically calibrate the user-selected Signal Out function.
  - MANUAL allows fine and coarse adjustments when calibrating the user-selected Signal Out function, and should be used for the 0.1V range or in cases where the outputs must be closely matched to the characteristics of the recording device. Start the calibration after configuration is complete).
4. In the Range field select the full-scale value of the output (see Section 3.3.9.1).
5. In the Recorder Offset field, input a bipolar voltage offset (see Section 3.3.9.2). This field is not available when Range is set to Current loop.
6. Either check the box to allow  $\pm 5\%$  over range, or leave blank to disallow over range if your recording device is sensitive to excess voltage or current.
7. Press the Apply button.
8. Go to the Analog Output Cal menu to calibrate the instrument under the new settings.

### 3.3.9.1. Analog Output Voltage Range Configuration

In its standard configuration, the analog outputs is set to output a 0 – 5 VDC signals. Several other output ranges are available (see Table 3-3). Each range is usable from -5% to + 5% of the rated span.

**Table 3-3: Analog Output Voltage Range Min/Max**

| RANGE SPAN | MINIMUM OUTPUT | MAXIMUM OUTPUT |
|------------|----------------|----------------|
| 0-100 mVDC | -5 mVDC        | 105 mVDC       |
| 0-1 VDC    | -0.05 VDC      | 1.05 VDC       |
| 0-5 VDC    | -0.25 VDC      | 5.25 VDC       |
| 0-10 VDC   | -0.5 VDC       | 10.5 VDC       |

The default offset for all ranges is 0 VDC.

### 3.3.9.2. Adding a Recorder Offset to the Analog Output

Some analog signal recorders require that the zero signal be significantly different from the baseline of the recorder in order to record slightly negative readings from noise around the zero point. This can be achieved in the calibrator by defining a zero offset, a small voltage (e.g., 10% of span).

### 3.3.9.3. Calibrating the Analog Output

When the Analog Output is configured/reconfigured, it must be calibrated. Navigate to the analog output in the Setup>Analog Outputs>Analog Output Cal menu. The analog output was configured in the Analog Output Cfg menu (Section 3.3.9) to be calibrated automatically (AUTO) or adjusted manually (MANUAL).

#### AUTO

The Signal Out field will show whether the Analog Output signal was set for automatic calibration, press the Start button. During automatic calibration, the instrument tells the output circuitry to generate a zero mV signal and high-scale point signal (usually about 90% of chosen analog signal scale) then measures actual signal of the output. Any error at zero or high-scale is corrected with a slope and offset.

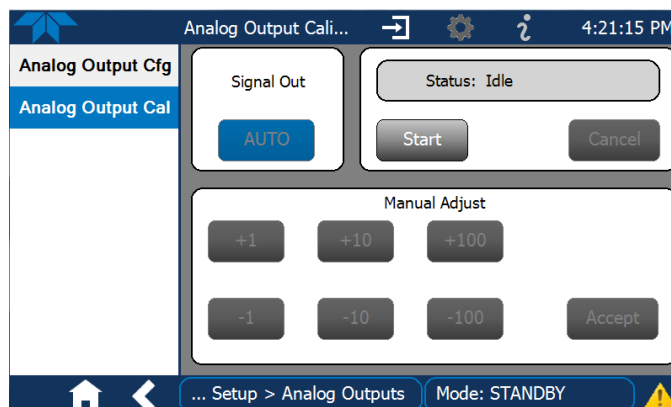

**Figure 3-27: Analog Output Auto Calibration Page**

**MANUAL**

For highest accuracy, the voltages of the analog outputs can be manually calibrated with a voltmeter connected across the output terminals (see Figure 3-28) and by changing the actual output signal level using the Manual Adjust buttons in 100, 10 or 1 count increments (Figure 3-29).

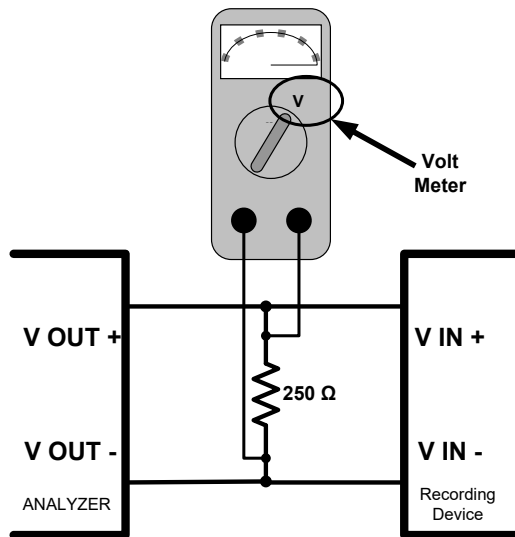

**Figure 3-28: Setup for Manually Calibrating the Analog Output**

**Table 3-4: Voltage Tolerances for the Analog Output Calibration**

| FULL SCALE | ZERO TOLERANCE | SPAN VOLTAGE | SPAN TOLERANCE | MINIMUM ADJUSTMENT (1 COUNT) |
|------------|----------------|--------------|----------------|------------------------------|
| 0.1 VDC    | ±0.0005V       | 90 mV        | ±0.001V        | 0.02 mV                      |
| 1 VDC      | ±0.001V        | 900 mV       | ±0.001V        | 0.24 mV                      |
| 5 VDC      | ±0.002V        | 4500 mV      | ±0.003V        | 1.22 mV                      |
| 10 VDC     | ±0.004V        | 4500 mV      | ±0.006V        | 2.44 mV                      |

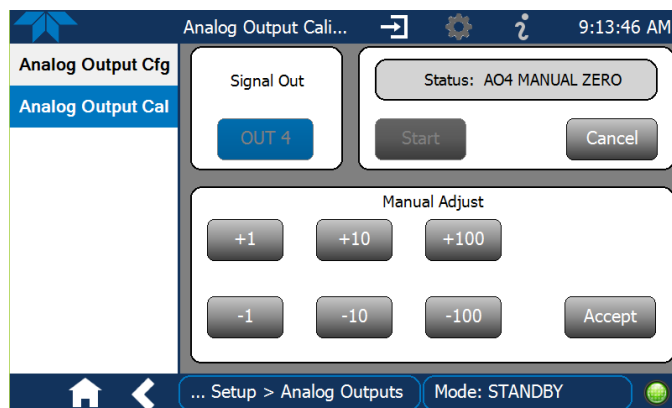

**Figure 3-29: Analog Output Manual Calibration Page**



### 3.3.10. SETUP>INSTRUMENT

The Instrument page shows product information and configurable instrument settings.

Model, Part, and Serial Numbers, Package and Driver Versions, and options information.

Platform, version, memory, etc.

Network settings, configurable in Setup>Comm menu.

Adjust date, hour, minutes, time zone (enable DST in Setup>Vars).

Configure Network Time Protocol settings for clock synchronization.

Select a language.

Get software/firmware updates when instrument is connected to an Internet-connected network.

**Figure 3-30: Setup>Instrument Menu**

### 3.3.10.1. Instrument Date/Time Adjustments

The Date/Time Settings menu allows changes to time zone, hour, minutes after the hour, and date, including auto-adjust for Daylight Savings Time.

If the Time Zone requires change, it must be set first, and the instrument must be restarted before making any other changes, including date or time, to ensure changes are not lost. Changes only to date and/or time do not require a reboot.

**Important**

#### IMPACT ON TIME ZONE

Allow adequate time for a Time Zone change to be accepted before restarting the instrument or the change will be lost. Verify the change by returning to Home page, then navigating back to the Date/Time Settings; if the selected Time Zone is highlighted, then the change is set for taking effect after the instrument is restarted.

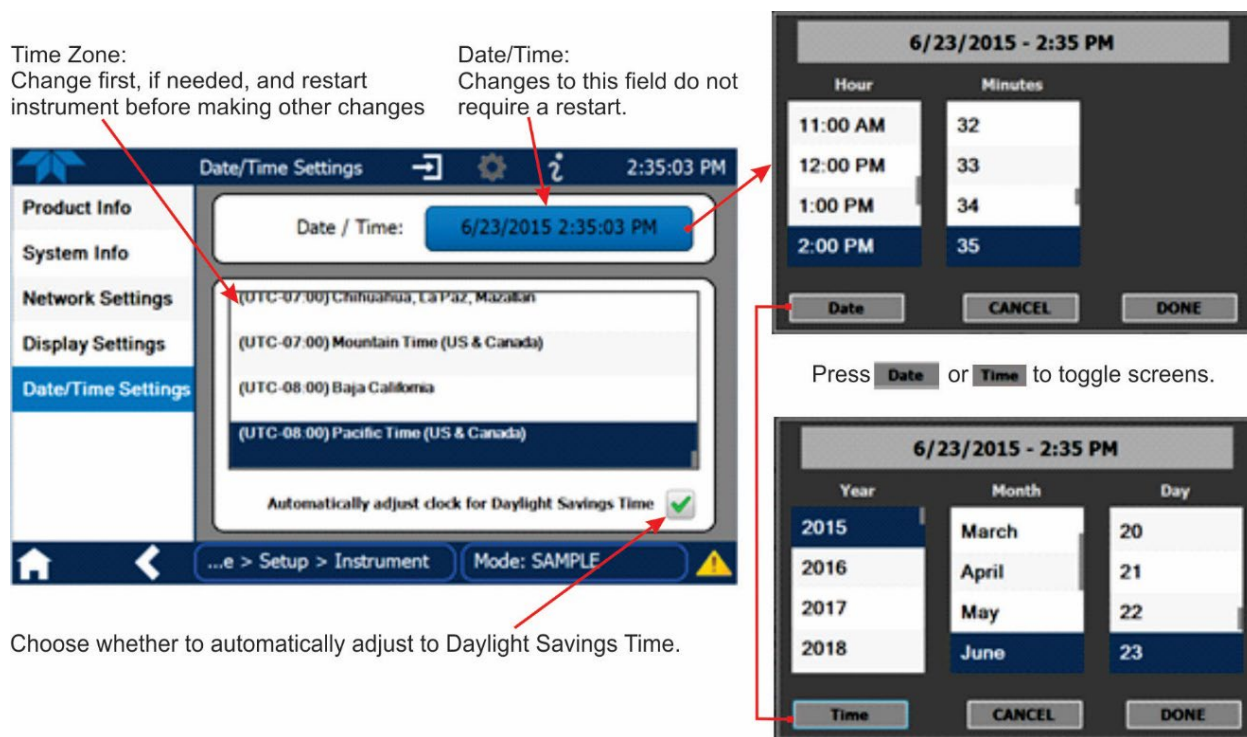

Figure 3-31: Date and Time Configuration Page

### 3.3.11. SETUP>COMM (COMMUNICATIONS)

The COMM page is for specifying the various communications configurations. (The last page on display prior to going to the Setup>COMM menu remains on display until one of the submenus is selected). See more on communication for remote operation and MODBUS protocol in Section 4.4.

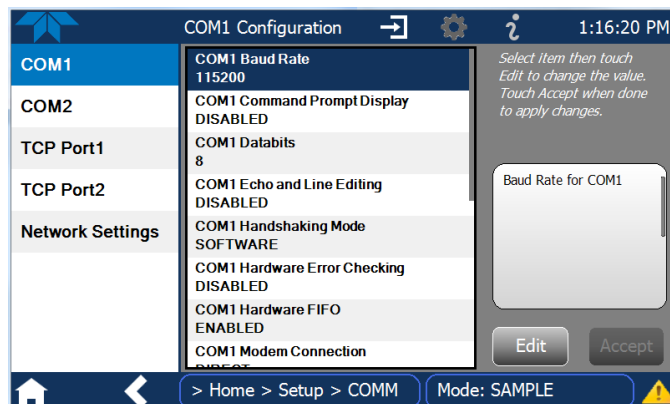

Figure 3-32: Communications Configuration Page

#### 3.3.11.1. COM1/COM2

Configure the instrument's COM1 or COM2 ports to operate in modes listed and described in Table 3-5.

Table 3-5: COM1/COM2 Configuration

| MODE                           | DESCRIPTION                                                                                                                                                                                                                                                                                                                                                                                    |
|--------------------------------|------------------------------------------------------------------------------------------------------------------------------------------------------------------------------------------------------------------------------------------------------------------------------------------------------------------------------------------------------------------------------------------------|
| <b>Baud Rate</b>               | Set the baud rate for the COM1 or COM2 port being configured. (If using a PC, both computer and instrument baud rates must match).                                                                                                                                                                                                                                                             |
| <b>Command Prompt Display</b>  | Enable/disable a command prompt to be displayed when in terminal mode.                                                                                                                                                                                                                                                                                                                         |
| <b>Data Bits</b>               | Set the data bits to 7 or 8 (typically set in conjunction with Parity and Stop bits).                                                                                                                                                                                                                                                                                                          |
| <b>Echo and Line Editing</b>   | Enable/disable character echoing and line editing.                                                                                                                                                                                                                                                                                                                                             |
| <b>Handshaking Mode</b>        | Choose SOFTWARE handshaking for data flow control (do NOT use SOFTWARE handshaking mode when using MODBUS RTU for Protocol mode; select only HARDWARE or OFF for MODBUS RTU), or HARDWARE for CTS/RTS style hardwired transmission handshaking. (This style of data transmission handshaking is commonly used with modems or terminal emulation protocols). Or choose to turn OFF handshaking. |
| <b>Hardware Error Checking</b> | Enable/disable hardware error checking.                                                                                                                                                                                                                                                                                                                                                        |
| <b>Hardware FIFO</b>           | Enable/disable the hardware First In – First Out (FIFO) for improving data transfer rate for that COM port.                                                                                                                                                                                                                                                                                    |
| <b>Modem Connection</b>        | Select either a modem connection or a direct cable connection.                                                                                                                                                                                                                                                                                                                                 |
| <b>Modem Init String</b>       | Input an initialization string to enable the modem to communicate.                                                                                                                                                                                                                                                                                                                             |
| <b>Multidrop</b>               | Enable/disable multidrop mode for multi-instrument configuration on a single communications channel. Multidrop requires a unique ID for each instrument in the chain (Setup>Vars>Instrument ID).                                                                                                                                                                                               |
| <b>Parity</b>                  | Select odd, or even, or no parity (typically set in conjunction with Data Bits and Stop Bits).                                                                                                                                                                                                                                                                                                 |

| MODE              | DESCRIPTION                                                                                                                                                                                                                                                                                                                                                  |
|-------------------|--------------------------------------------------------------------------------------------------------------------------------------------------------------------------------------------------------------------------------------------------------------------------------------------------------------------------------------------------------------|
| <b>Protocol</b>   | Select among the communications protocols: TAPI (serial communication), MODBUS RTU, or MODBUS ASCII. (See Section 5 for remote operation).                                                                                                                                                                                                                   |
| <b>Quiet Mode</b> | Enable/disable Quiet mode, which suppresses any feedback from the analyzer (such as warning messages) to the remote device and is typically used when the port is communicating with a computer program where such intermittent messages might cause communication problems. Such feedback is still available, but a command must be issued to receive them. |
| <b>RS-485</b>     | Enable/disable the rear panel <b>COM2</b> Port for RS-485 communication. RS-485 mode has precedence over Multidrop mode if both are enabled. Also, RS-485 configuration disables the rear panel USB port.                                                                                                                                                    |
| <b>Security</b>   | Enable/disable the requirement for a password for this serial port to respond. The only command that is active is the request-for-help command (? CR).                                                                                                                                                                                                       |
| <b>Stop bits</b>  | Select either 0 or 1 stop bit (typically set in conjunction with Parity and Data bits).                                                                                                                                                                                                                                                                      |

### 3.3.11.2. TCP Port1

TCP Port1 allows choosing whether or not to display the command prompt, and to edit the Port 1 number for defining the terminal control port by which terminal emulation software addresses the instrument; also allows or disabling security on this port.

### 3.3.11.3. TCP Port2

TCP Port2 is configured with the port number for MODBUS.

### 3.3.11.4. Network Settings

The Setup>Comm>Network Settings menu is for Ethernet configuration. The address settings default to automatic configuration by Dynamic Host Configuration Protocol (DHCP). Most users will want to configure the instrument with a static IP address: click the Static radio button to manually assign a static IP address (consult your network administrator, and see Table 3-6 for information).

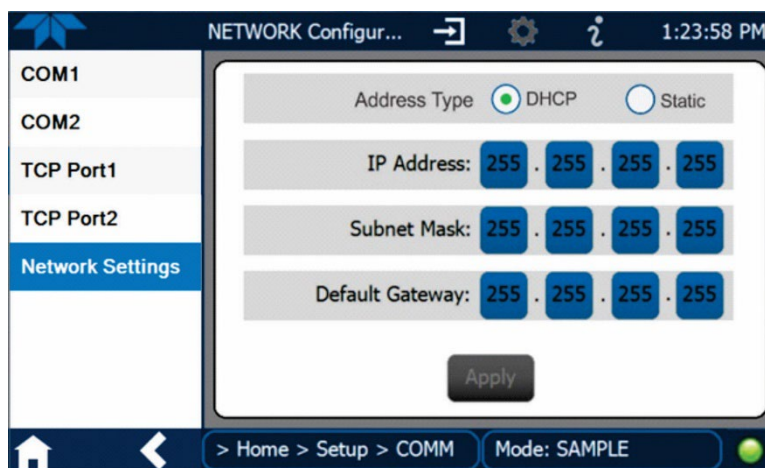

Figure 3-33: Network Configuration Page

**Table 3-6: LAN/Ethernet Configuration Properties**

| PROPERTY               | DESCRIPTION                                                                                                                                                                                                                                                                                                                                                                                                                                                                 |
|------------------------|-----------------------------------------------------------------------------------------------------------------------------------------------------------------------------------------------------------------------------------------------------------------------------------------------------------------------------------------------------------------------------------------------------------------------------------------------------------------------------|
| <b>IP address</b>      | A string of four packets of 1 to 3 numbers each (e.g. 192.168.76.55.) is the internet protocol address of the instrument itself.                                                                                                                                                                                                                                                                                                                                            |
| <b>Subnet Mask</b>     | A string of four packets of 1 to 3 numbers each (e.g. 255.255.252.0) number that masks an IP address, and divides the IP address into network address and host address and identifies the LAN to which the device is connected. All addressable devices and computers on a LAN must have the same subnet mask. Any transmissions sent to devices with different subnets are assumed to be outside of the LAN and are routed through the gateway computer onto the Internet. |
| <b>Default Gateway</b> | A string of numbers very similar to the Instrument IP address (e.g. 192.168.76.1.) that is the address of the computer used by your LAN and serves as a router to access the Internet or another network.                                                                                                                                                                                                                                                                   |

This page intentionally left blank.

## 4. OPERATION

The T753U Portable Calibrator can be in either **Generate** mode or **Standby** mode and can be used as an O<sub>3</sub> photometer (Section 4.3). When in basic Generate mode, the calibrator is constantly generating either Ozone at a concentration set by the user or Zero. The calibrator can also perform several functions in a series of steps called a Sequence (Section 4.1), first programmed through the Setup>Sequence menu (Section 3.3.7) or a Level if using Dasibi (Section 4.2), programmed through the Setup>Levels menu (Section 3.3.8).

To run the basic generation of Ozone or Zero Air (refer to Figure 4-1), in the Generate menu press the AUTO button, and in the next screen select O<sub>3</sub> or ZERO in the gas field. If needed, change the concentration and/or units, then press the Generate button and view the status in the Home page.

It is also possible to change the output flow, which has specific requirements and is described in Section 4.4

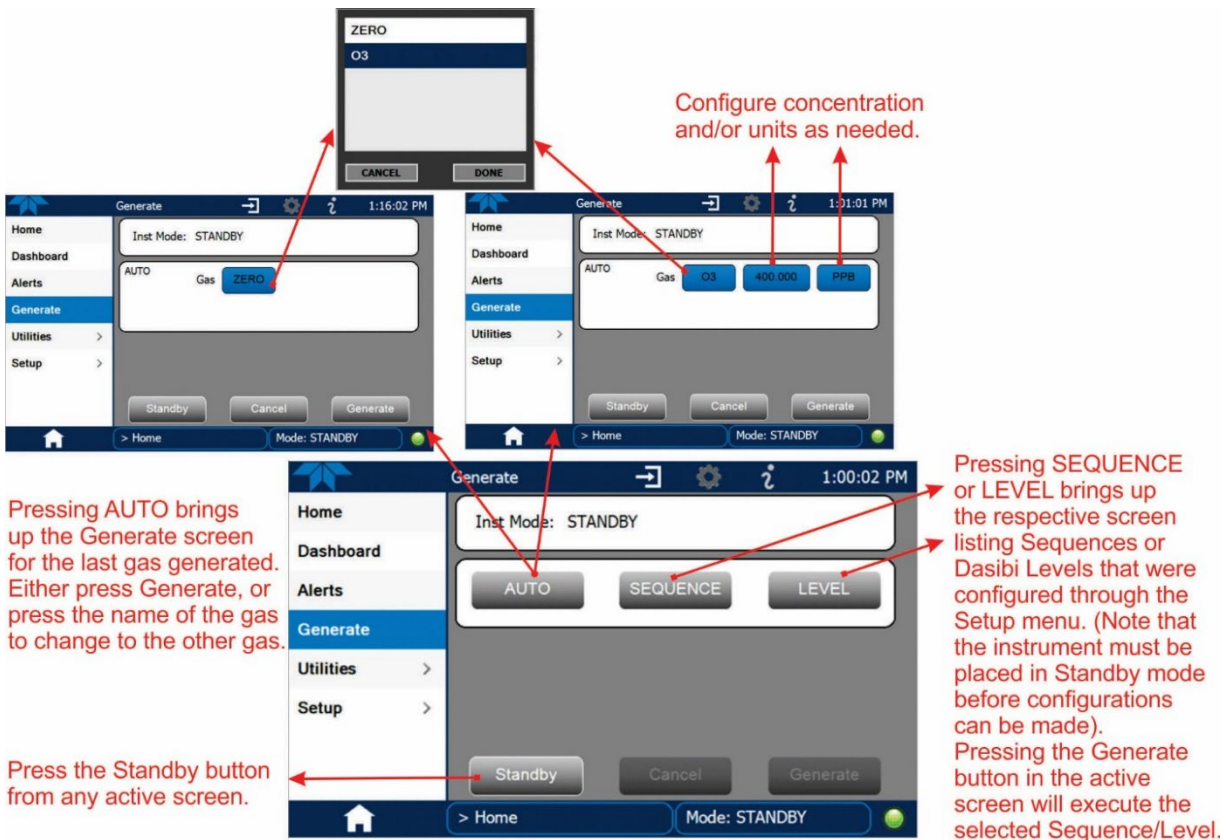

Figure 4-1: Activating the Generate Mode

The calibrator will now enter **GENERATE** mode.

### 4.1. AUTOMATIC OPERATION USING SEQUENCES

The T753U calibrator can be set up to perform automatic calibration sequences. Each sequence is a database of single or multiple steps where each single step is an instruction that causes the instrument to perform a calibration operation. These steps are grouped under a user-defined sequence name, and each sequence is configured in the Setup>Sequence menu (Section 3.3.7). These sequences can perform all of the calibration operations

available (see Table 3-2) for manual operation; they can be configured to be triggered by any of several methods:

- touchscreen
- internal timer: preprogrammed in the Sequence
- the external digital control inputs
- communications interface (such as RS-232 or Ethernet)
- sub-processes in another sequence

#### 4.1.1. ACTIVATING A SEQUENCE FROM THE TOUCHSCREEN

In the Generate menu, press the SEQUENCE button, and in the EXECSEQ field that appears, select the name of the sequence in the scrollable list and press the Generate button.

Suspend the Sequence by pressing the Standby button.

#### 4.1.2. ACTIVATING A SEQUENCE WITH THE INTERNAL TIMER

Typically a sequence will start automatically at the time that was input when first configured (Section 3.3.7) if the Timer was enabled. To enable the Timer or change the settings, navigate to the Setup>Sequences menu, select the sequence by name and in the Timer field check the Enable box. Press the Edit button to either view or change the Timer settings.

#### 4.1.3. ACTIVATING A SEQUENCE WITH THE EXTERNAL DIGITAL CONTROL INPUTS

This method triggers the sequence from an external control source that was electrically connected per the instructions in Section 2.3.1.4, so that the calibrator can operate in a slave mode. To enable the Input CC feature, navigate to the Setup>Sequences menu, select the sequence by name and in the Input CC field check the Enable box. Press the Edit button to either view or change the switch settings. (Refer to Section 3.3.7 and Table 3-2 for configuration information).

#### 4.1.4. ACTIVATING A SEQUENCE OR DEFAULTING TO CONTROL OTHER DEVICES

This method triggers the sequence to set or reset the calibrator's digital control outputs. It is very useful in situations where the control outputs are being used to trigger other devices that need to be turned off and on in synch with the operation of the calibrator as it progresses through the sequence. To enable this feature, navigate to the Setup>Sequences menu, select the sequence by name and in the Output CC field check the Enable box. Press the Edit button to either view or change the switch settings. (Refer to Section 3.3.7 and Table 3-2 for configuration information).

#### 4.1.5. ACTIVATING A SEQUENCE THROUGH A COMMUNICATIONS INTERFACE

This is a method that is carried out through remote communication control. See Section 4.4.



### 4.1.6. ACTIVATING A SEQUENCE AS A SUBPROCESS IN ANOTHER SEQUENCE

This method is a way of nesting other often-used operations (subprocesses) within a sequence. Subprocess are sequences that can be reused rather than be recreated for other new sequences. Create the subprocess as sequence through the Setup>Sequences menu; then insert it as a nested sequence while creating or editing the “overhead” sequence with the EXECSEQ step.

## 4.2. AUTOMATIC OPERATION USING LEADS LEVELS

The T753U calibrator can be equipped with a version of firmware that includes support for LEADS, a data collection and analysis system specifically designed for handling meteorological and environmental data, particularly when there is a need to integrate data and control instrumentation from several different manufacturers. When a T753U calibrator is equipped with the optional LEADS software used in conjunction with data loggers located in a central data analysis facility, it is possible to collect and buffer data between the various calibrators, analyzers and metrological equipment remotely located at an air monitoring station.

Because LEADS was originally developed for use with TNRCC using Dasibi 5008 calibrators, the LEADS version of the T753U includes support for Dasibi “Dot” serial data commands and operational “LEVELs”. (For more information on the LEADS system, please go to <http://www.meteostar.com/>).

The Dasibi “Dot” commands form a text-based (ASCII) data protocol that is transmitted between a control computer, such as a XENO data logger, and a calibrator or ambient gas analyzer over an RS-232 connection. The details of the protocol are beyond the scope of this document, but in its simplest form the protocol is based on a two or three digit integer preceded by a control-A and a period (.) and then followed by a “!” and a two digit checksum.

EXAMPLE:

**^A.xxx!nn**

A T753U equipped with LEADS software can be simultaneously operated over the same COM port using standard Teledyne API’s serial data commands.

### 4.2.1.1. Activating Levels

Levels are individually started and stopped either by an operator locally by using the touchscreen menu or remotely through a serial data operation over the RS-232 or Ethernet ports.

To activate an existing Level, from Home page navigate to the Generate menu, press the LEVEL button, then select the Level by its ID, and press the Generate button. To stop, press the Standby button.

### 4.3. OPERATING THE CALIBRATOR AS AN O<sub>3</sub> PHOTOMETER

The T753U can easily be configured to measure an external source of ozone.

#### 4.3.1. SET UP FOR OPERATION AS AN O<sub>3</sub> PHOTOMETER

To convert the T753U from an O<sub>3</sub> calibrator to an O<sub>3</sub> photometer:

1. Remove the two loop-back tubing assemblies on the communications and output panel connected to the 'PHOTO IN' and 'PHOTO ZERO IN' fittings.
2. Connect the ozone source to be measured to the 'PHOTO IN' fitting.
  - This gas must be supplied at atmospheric pressure.
3. Connect a reference gas (Zero Air) for the photometer to the 'PHOTO ZERO IN' fitting.
  - This gas must be supplied at atmospheric pressure. To avoid interference effects, the reference gas should be from the same source that is being used to feed the ozone generator that is being assayed.

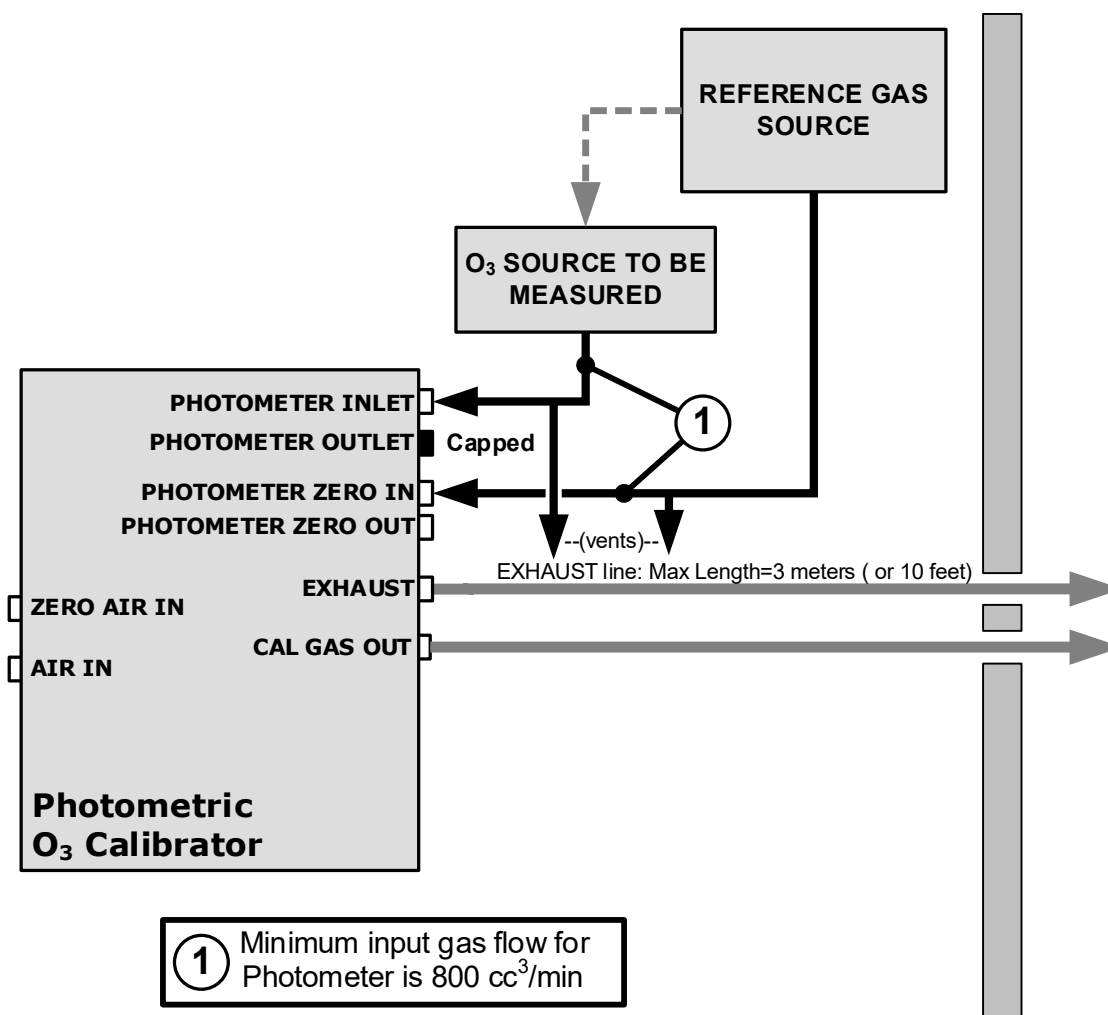
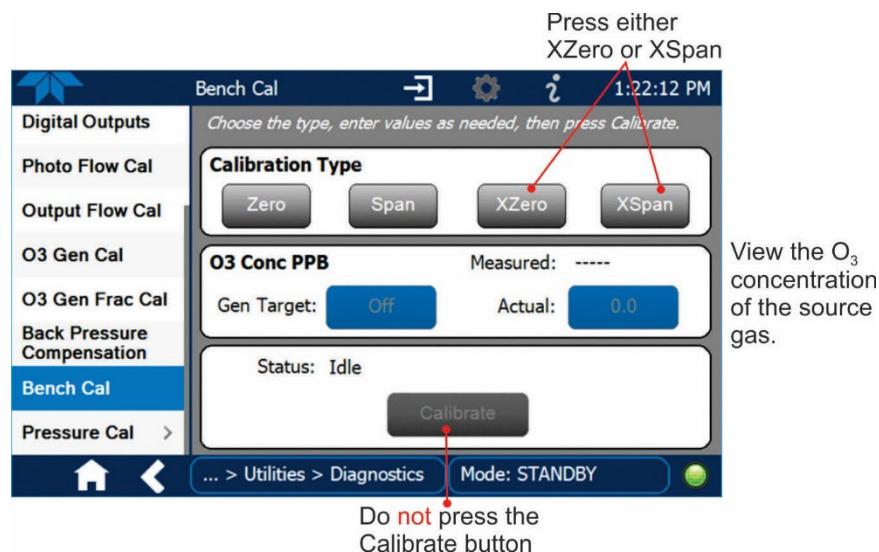

Figure 4-2: Set up to Measure an External O<sub>3</sub> Source

To use the T753U as a photometer:

1. Place the calibrator in Standby mode (Generate>Standby).
2. Ensure that the Setup>Vars menu shows:
  - O3 Gen Mode has BNCH selected
  - O3 Bench Only is set to ON
  - ZA Pump Enable is set to OFF
3. Navigate to Utilities>Diagnostics>Bench Cal and press either XZero or XSpan, as needed, and view the O<sub>3</sub> concentration of the source gas.



**Figure 4-3: Viewing Concentration from External Ozone Source**

Do NOT press the Calibrate button, which will cause the instrument to recalculate its internal Slope and Offset values. (See Section 6.1.3 for O<sub>3</sub> photometer calibration).

#### 4.4. RESETTING THE OUTPUT FLOW RATE

##### Important

##### IMPACT ON READINGS OR DATA

**Each time there is a change made to the output flow, two critical calibrations must be performed:**

**O3 Gen Cal and O3 Gen Frac Cal (Utilities>Diagnostics).**

**For optimal performance each time there is a change made to the Output Flow, it is recommended that ozone pressure, regulator pressure, and photometer pressure also be calibrated (Utilities>Diagnostics>Pressure Cal). See Section 6.3**

The output flow rate can be changed by adjusting the Regulator knob, which must be followed by recalibration of O3 Gen Cal and O3 Gen Frac Cal. It is recommended that ozone pressure, regulator pressure, and photometer pressure also be recalibrated for optimal performance. The procedures for changing the output flow rate and recalibrating are set forth in Section 4.4.2.

However, please note that for greatest efficiency, it is also important to consider both the total gas flow requirements of all analyzers connected to the output manifold and the minimum output flow of the O<sub>3</sub> generator before resetting the output flow rate. How to calculate the total output flow rate is presented first in Section 4.4.1.

#### 4.4.1. CALCULATING OUTPUT FLOW RATE

First, add the sum of the flow requirements of all of the instruments to which the T753U will be supplying calibration gas plus 1 LPM excess flow. For example, if the T753U is expected to supply calibration gas mixtures simultaneously to two analyzers, each requiring 0.8 LPM, the minimum Total Flow output would be:

$$(0.8 + 0.8) + 1.0 = 2.6 \text{ LPM}$$

Second, calculate the flow rate requirements of the O<sub>3</sub> generator output, which must remain above the minimum specification of 10 PPB\*LPM. Use the following equation to determine the minimum flow rate (F<sub>T</sub>) for the O<sub>3</sub> generator output:

$$F_T \geq \frac{10 \text{ ppb} \bullet \text{LPM}}{O \text{ Conc}}$$

Compare the values calculated from the above formulae; the greater of the two is the minimum Total Flow that must be set.

#### 4.4.2. OUTPUT FLOW RESET PROCEDURE

To reset the output flow:

1. Navigate to the Dashboard page to view the Output Flow value.
2. Open the Input and Control Panel of the calibrator by unscrewing the two screws at the top of the Input and Control Panel.
3. Pull the regulator knob (Figure 4-4) outward to unlock it, and turn the knob only slightly, allowing time for the Output Flow value to change and stabilize before continuing to adjust the regulator until the desired flow is achieved.

The calibrator's display shows the approximate output flow based on the measured regulator pressure, but this flow should be verified with an independent calibrated flow meter attached to the CAL GAS outlet on the back of the instrument

4. When complete, push the pressure regulator knob back in to lock.
5. Close the Input and Control Panel.
6. REQUIRED: run the O<sub>3</sub> Gen Cal and O<sub>3</sub> Gen Frac Cal calibrations in the Utilities>Diagnostics menu.
7. IMPORTANT: recalibrate the ozone, regulator, and photometer pressures via the Utilities>Diagnostics>Pressure Cal menu.

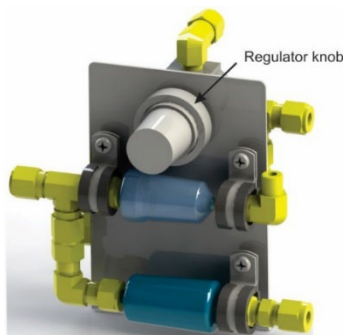

Figure 4-4: Output Pressure Regulator Assembly

## 5. COMMUNICATIONS FOR REMOTE OPERATION

### 5.1. USING THE COMMUNICATION PORTS

The communications ports were described in Section 2.3.1.6, along with their connection instructions, and their setup instructions were provided in Section 3.3.11. These ports allow the ability to communicate with, issue commands to, and receive data from the analyzer through an external computer system or terminal.

This section provides pertinent information regarding communication equipment, the communications ports, and communications protocol. Data acquisition is set up through the Datalogger (Section 3.3.1).

### 5.2. DATA TERMINAL / COMMUNICATION EQUIPMENT (DTE DCE)

RS-232 was developed for allowing communications between data terminal equipment (DTE) and data communication equipment (DCE). Basic terminals always fall into the DTE category whereas modems are always considered DCE devices. The difference between the two is the pin assignment of the Data Receive and Data Transmit functions.

- DTE devices receive data on pin 2 and transmit data on pin 3.
- DCE devices receive data on pin 3 and transmit data on pin 2.

To enable the analyzer to be used with terminals (DTE), modems (DCE) and computers (which can be either), a switch mounted on the electrical connections panel, labeled DCE DTE (Figure 2-3), allows the user to set the RS-232 configuration for one of these two data devices. This switch exchanges the Receive and Transmit lines on RS-232 emulating a cross-over or null-modem cable. The switch has no effect on COM2.

### 5.3. MODES, BAUD RATE AND SERIAL COMMUNICATION

Referring to Table 3-5, use the SETUP>COMM menu to configure COM1 (labeled RS232 on instrument rear panel) and/or COM2 (labeled COM2 on instrument rear panel) for communication modes, baud rate and serial communications. If using a USB option communication connection, setup requires that the instrument's baud rate and personal computer baud rate match.

#### 5.3.1. SERIAL COMMUNICATION: RS-232

The RS232 and COM2 communications ports operate on the RS-232 protocol (default configuration). Configurations possible for these two ports are:

- RS232 port can also be configured to operate in single or RS-232 Multidrop mode (Option 62).
- COM2 port can be left in its default configuration for standard RS-232 operation including multidrop, or it can be reconfigured for half-duplex RS-485 operation (please contact the factory for this configuration).

**Note**

**When COM2 port is in use, except for multidrop communication, the rear panel USB port cannot be used. (Alternatively, when the USB port is enabled, COM2 port cannot be used except for multidrop).**

A code-activated switch (CAS), can also be used on either port to connect typically between 2 and 16 send/receive instruments (host computer(s) printers, data loggers, analyzers, monitors, calibrators, etc.) into one communications hub. Contact Teledyne API Sales (front cover, this manual) for more information on CAS systems.

### 5.3.2. SERIAL COMMUNICATION: RS-485 (OPTION)

The COM2 port of the instrument's rear panel is set up for RS-232 communication but can be reconfigured for RS-485 communication. Contact Technical Support for reconfiguration unless this option was elected at the time of purchase, then the rear panel was preconfigured at the factory.

## 5.4. ETHERNET

When using the Ethernet interface, the analyzer can be connected to any standard 10BaseT or 100BaseT Ethernet network via low-cost network hubs, switches or routers. The interface operates as a standard TCP/IP device on port 3000. This allows a remote computer to connect through the network to the analyzer using NumaView™ Remote, terminal emulators or other programs.

The Ethernet connector has two LEDs that are on the connector itself, indicating its current operating status.

**Table 5-1: Ethernet Status Indicators**

| LED              | FUNCTION                                 |
|------------------|------------------------------------------|
| amber (link)     | On when connection to the LAN is valid.  |
| green (activity) | Flickers during any activity on the LAN. |

The analyzer is shipped with DHCP enabled by default. This allows the instrument to be connected to a network or router with a DHCP server; however, it should be configured with a Static IP address as soon as practical. See Section 3.3.11.4 for configuration details.

## 5.5. MODBUS PROTOCOL

The following set of instructions assumes that the user is familiar with MODBUS communications, and provides minimal information to get started. For additional instruction, please refer to the Teledyne API MODBUS manual, PN 06276. Also refer to [www.modbus.org](http://www.modbus.org) for MODBUS communication protocols.

### Minimum Requirements

- Instrument firmware with MODBUS capabilities installed
- MODBUS-compatible software (TAPI uses MODBUS Poll for testing; see [www.modbustools.com](http://www.modbustools.com))
- Personal computer
- Communications cable (Ethernet or USB or RS232)
- Possibly a null modem adapter or cable

### 5.5.1.1. MODBUS Com Port Configuration

MODBUS communications can be configured for transmission over Ethernet or serial COM port through the Setup>Comm menu. Make the appropriate cable connections (Ethernet or COM port) between the instrument and a PC.

Ethernet: MODBUS is available on TCP port 502. By default, port 502 is assigned to the instrument's TCP Port 2. In the Setup>Comm> TCP Port menu, check to see that it is set to "502" (Figure 5-1).

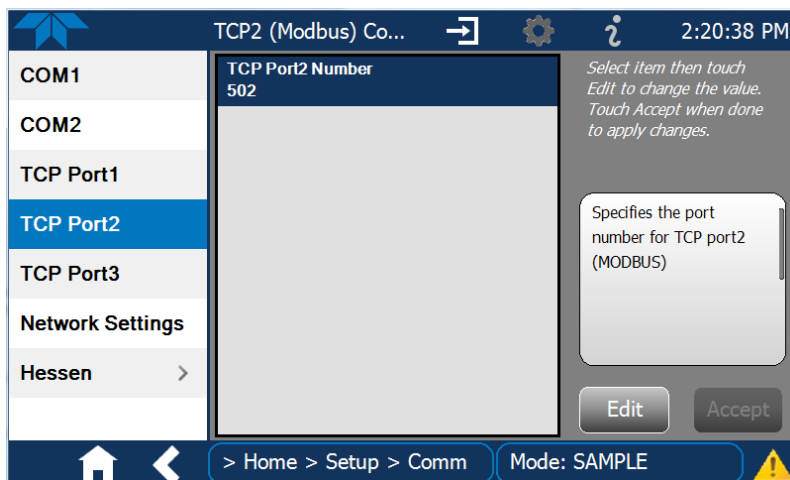

Figure 5-1: MODBUS via Ethernet

Serial COM: Both COM1 (labeled "RS232" on the instrument's rear panel) and COM2 are configurable for RS-232 or RS-485 communication with either MODBUS RTU or MODBUS ASCII transmission modes. In the Setup>Comm COM1[COM2] menu, edit the Protocol parameter to select a MODBUS transmission mode; edit Baud Rate, Parity, Data Bits, etc., if necessary (see descriptions in Table 3-5).

#### Important

**When using MODBUS RTU, ensure that the COM1[COM2] Handshaking Mode is set to either Hardware or OFF. Do NOT set it to Software.**

Press the Accept button to apply the settings. (Figure 5-2 shows an example for MODBUS RTU).

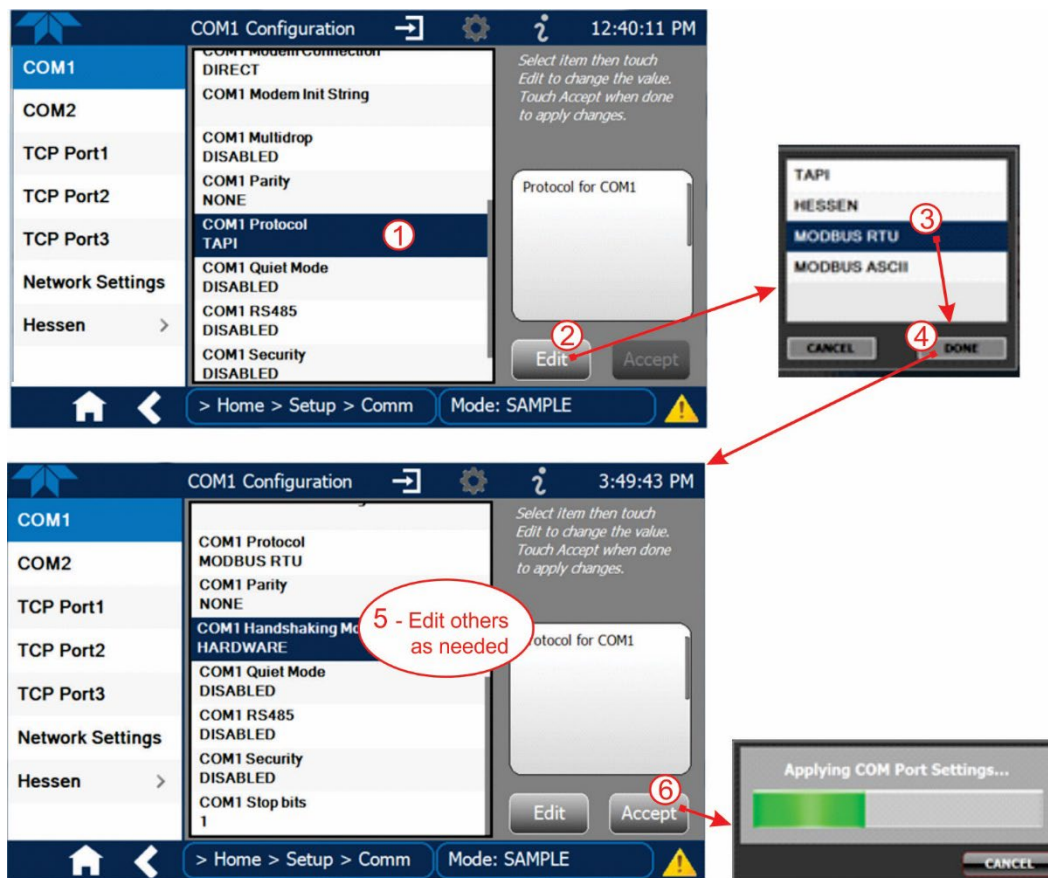

Figure 5-2: MODBUS via Serial Communication (example)

**Important**

When more than one analyzer is connected to the network, create a unique identification number for each in the Setup>Vars>Instrument ID menu.

Next, for the settings to take effect, power off the analyzer, wait 5 seconds, and power it on again.



## 6. CALIBRATION AND VERIFICATION

Basic electronic calibration of the Calibrator is performed at the factory. Normally there is no need to perform this factory calibration in the field however, the performance of several of the instrument's key subsystems should be verified periodically and if necessary adjusted. These subsystems are:

- O<sub>3</sub> Photometer: The O<sub>3</sub> photometer performance should be periodically verified against an external standard (see Section 6.1).
- O<sub>3</sub> Generator: The O<sub>3</sub> generator should be periodically calibrated (see Section 6.2).

### 6.1. VERIFYING/CALIBRATING THE O<sub>3</sub> PHOTOMETER

The accuracy of calibration gas produced by the T753U depends entirely on the accuracy of the photometer; therefore, it is very important that the photometer is operating properly and accurately.

The verification procedure can be performed using the instrument's internal O<sub>3</sub> generator (see Figure 6-1) or an external source of O<sub>3</sub> (see Figure 6-2). In either case, an external source of zero air (such as a Teledyne API's Model 701 Zero Air Generator) is required.

#### 6.1.1. SETUP FOR VERIFYING AND CALIBRATING THE O<sub>3</sub> PHOTOMETER

**Note**

This operation requires an external reference photometer.

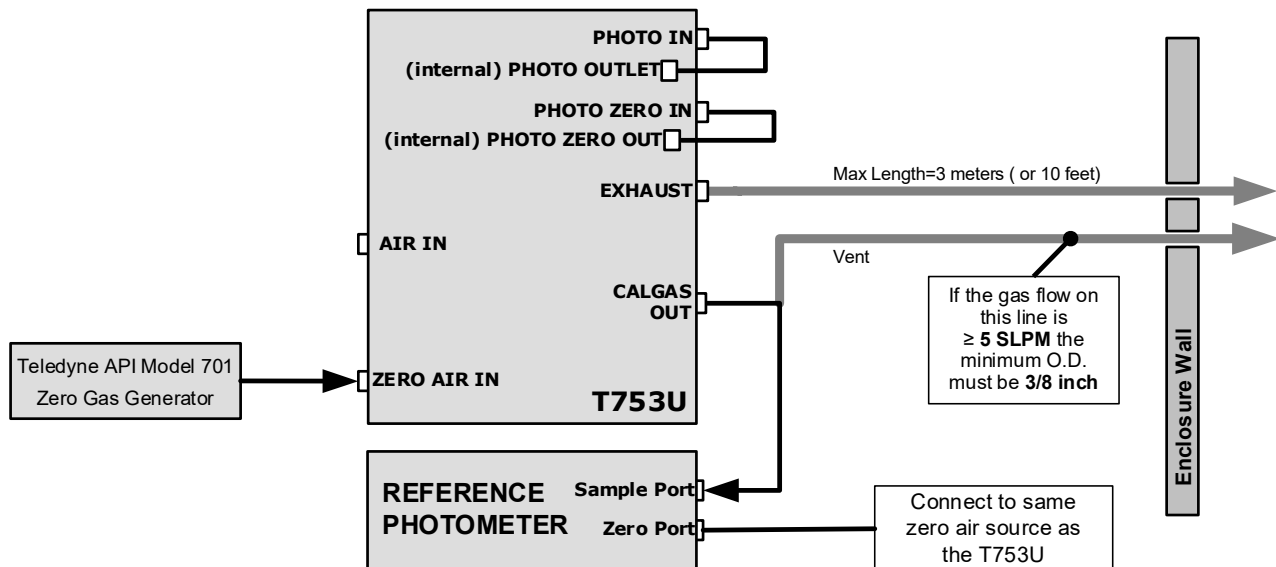

Figure 6-1: Set up for Verifying O<sub>3</sub> Photometer Using Internal O<sub>3</sub> Generator

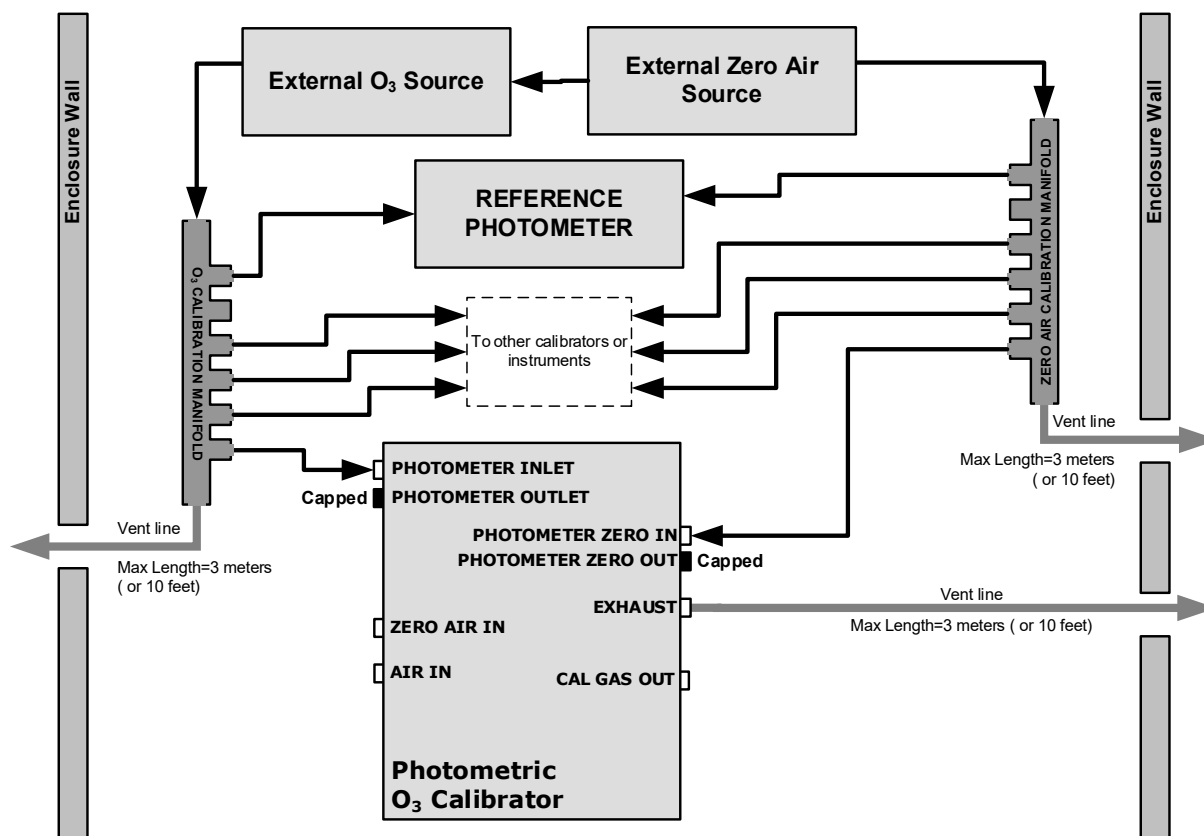

Figure 6-2: Set up for Verifying Optional O<sub>3</sub> Photometer Using an External O<sub>3</sub> Generator

**Note**

The manifolds as shown in the above drawing are oriented to simplify the drawing.

All unused ports should be capped.

A Minimum of 1.1 LPM is required for the external zero air source.

### 6.1.1.1. Calibration Manifold Exhaust/Vent Line

The manifold’s excess gas should be vented to a suitable vent outside of the room. This vent should be of large enough internal diameter to avoid any appreciable pressure drop, and it must be located sufficiently downstream of the output ports to assure that no ambient air enters the manifold due to eddy currents or back diffusion.

**Note**

It is recommended that the calibration manifold’s exhaust vent have a minimum internal diameter of 3/8 inch and a maximum length of 3 meters (or 10 feet).

### 6.1.2. VERIFYING O<sub>3</sub> PHOTOMETER PERFORMANCE

To verify the performance of the internal photometer, navigate to the Generate menu:

1. Ensure that the calibrator is in Standby mode.
2. Press the AUTO button.
3. In the next screen, set the gas to O<sub>3</sub>, and set the concentration and units, then press the Generate button.

4. Allow at least 10 minutes until the Actual reading stabilizes (view on Homescreen).
5. Record the reading for Actual and the reading for the external reference photometer.
6. Repeat this procedure for as many points along the performance range of the calibrator as required.

The readings recorded from the Actual field and the external reference photometer should be within 1% of each other.

### 6.1.3. CALIBRATING THE O<sub>3</sub> PHOTOMETER

The following procedure sets values held in the calibrator's memory for zero point **OFFSET** and **SLOPE**.

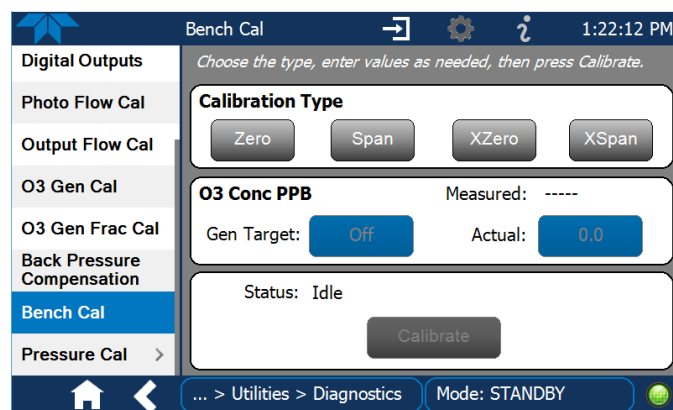

Figure 6-3: O<sub>3</sub> Photometer Bench Cal

#### 6.1.3.1. Photometer Zero Calibration

To set the zero point offset for the T753U Portable Calibrator's photometer:

1. Ensure that the calibrator is in Standby mode (Generate menu).
2. Go to the Utilities>Diagnostics>Bench Cal menu.
3. Press either the Zero button if using the internal O<sub>3</sub> generator or the XZero button if using an external O<sub>3</sub> generator.
4. Allow Zero air to flow into the PHOTO IN port for at least 10 minutes.
5. Press the Calibrate button in the Status field.
6. On the next screen, either confirm performing the Bench Calibration by pressing Yes, or leave photometer bench calibration values unchanged by pressing No, which will return the display to the Bench Cal page.

#### 6.1.3.2. Photometer Span Calibration

To set the response SLOPE for the T753U Portable Calibrator's photometer:

1. Ensure that the calibrator is in Standby mode (Generate menu).
2. Navigate to the Utilities>Diagnostics>Bench Cal menu.

3. Press either the Span button if using the internal O<sub>3</sub> generator or the XSpan button if using an external O<sub>3</sub> generator.
4. Allow calibration gas (a 400 ppb O<sub>3</sub> span concentration is recommended) to flow into the PHOTO IN port for at least 10 minutes.
5. In the O<sub>3</sub> Conc PPB field press the button for Actual and input the exact span cal value as measured by the reference photometer, then press Enter.
6. In the Status field, press the Calibrate button.
7. On the next screen, either confirm performing the Bench Calibration by pressing Yes, or leave photometer bench calibration values unchanged by pressing No, which will return the display to the Bench Cal page.

#### 6.1.4. O<sub>3</sub> PHOTOMETER BACKPRESSURE COMPENSATION CALIBRATION

Any time there is a pneumatic configuration change, there is risk of impacting the internal measure/reference pressure. To compensate for this, a backpressure compensation calibration is required after each change. In the Generate menu place the calibrator in Standby mode, then navigate to the Utilities>Diagnostics>Back Pressure Compensation menu (Figure 6-4) to run the calibration.

This operation will take a few minutes.

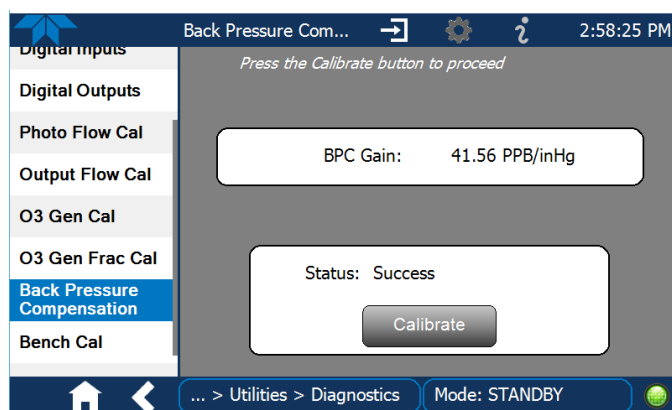

Figure 6-4: Back Pressure Compensation

## 6.2. CALIBRATING THE O<sub>3</sub> GENERATOR

The O<sub>3</sub> Generator is calibrated at the factory for 5 LPM instrument output flow. It should not need to be recalibrated except when there is reason to change the output flow rate (Section 4.4). The T753U calibrator's software includes a routine for automatically calibrating the O<sub>3</sub> generator, based on calibration tables of drive voltages stored in the calibrator's memory. These tables are used by the T753U to set initial O<sub>3</sub> generator drive settings according to the concentration that is requested. (One table is for concentrations above 50 ppb; the other is for low concentrations, which is used to get a discernable voltage for concentrations between 0-50 ppb).

When the T753U is operated in Bench (BNCH) mode (Setup>Vars>O<sub>3</sub> Gen Mode), the table is used for the starting voltage. After a short delay time (~2 minutes), the bench feedback control will take over and control the O<sub>3</sub> generator drive voltage to match the concentration requested.

When the T753U is operated in Constant (CNST) mode (Setup>Vars>O<sub>3</sub> Gen Mode), the initial O<sub>3</sub> generator drive setting will be set by the calibration table and does not change.

## 6.3. CALIBRATING GAS PRESSURE SENSORS

The T753U Calibrator has three pressure sensors: two that monitor gas flow pressure (Regulator pressure sensor and Photometer Sample Gas pressure sensor) and one that monitors ambient pressure (O<sub>3</sub> Generator Regulator pressure sensor). The data collected by these sensors are used to compensate the final concentration calculations for changes in atmospheric pressure and are stored in the CPU's memory as Dashboard functions:

**Table 6-1: T753U Pressure Sensors**

| SENSOR                                                          | DASHBOARD TAG             | UNITS          |
|-----------------------------------------------------------------|---------------------------|----------------|
| Regulator Pressure Sensor                                       | <b>Regulator Pressure</b> | <b>PSIG</b>    |
| Photometer Sample Gas Pressure Sensor                           | <b>Photo Pressure</b>     | <b>IN-HG-A</b> |
| (T753U only) O <sub>3</sub> Generator Regulator Pressure Sensor | <b>O3 Press</b>           | <b>PSIG</b>    |

### 6.3.1. GAS PRESSURE SENSOR CALIBRATION SET UP

The procedures described in this section require an independent, calibrated pressure meter/monitor to be attached at the locations shown in Figure 6-5. The pressure meter connections for the three pressure sensors are as follows:

- Regulator Pressure      Capped fitting on the output pressure regulator assembly (Figure 6-6)
- O<sub>3</sub> Pressure              Capped fitting on ozone generator housing (Figure 6-7)
- Photometer Pressure      Refer to barometric pressure station for ambient atmospheric pressure at the calibrator's location.

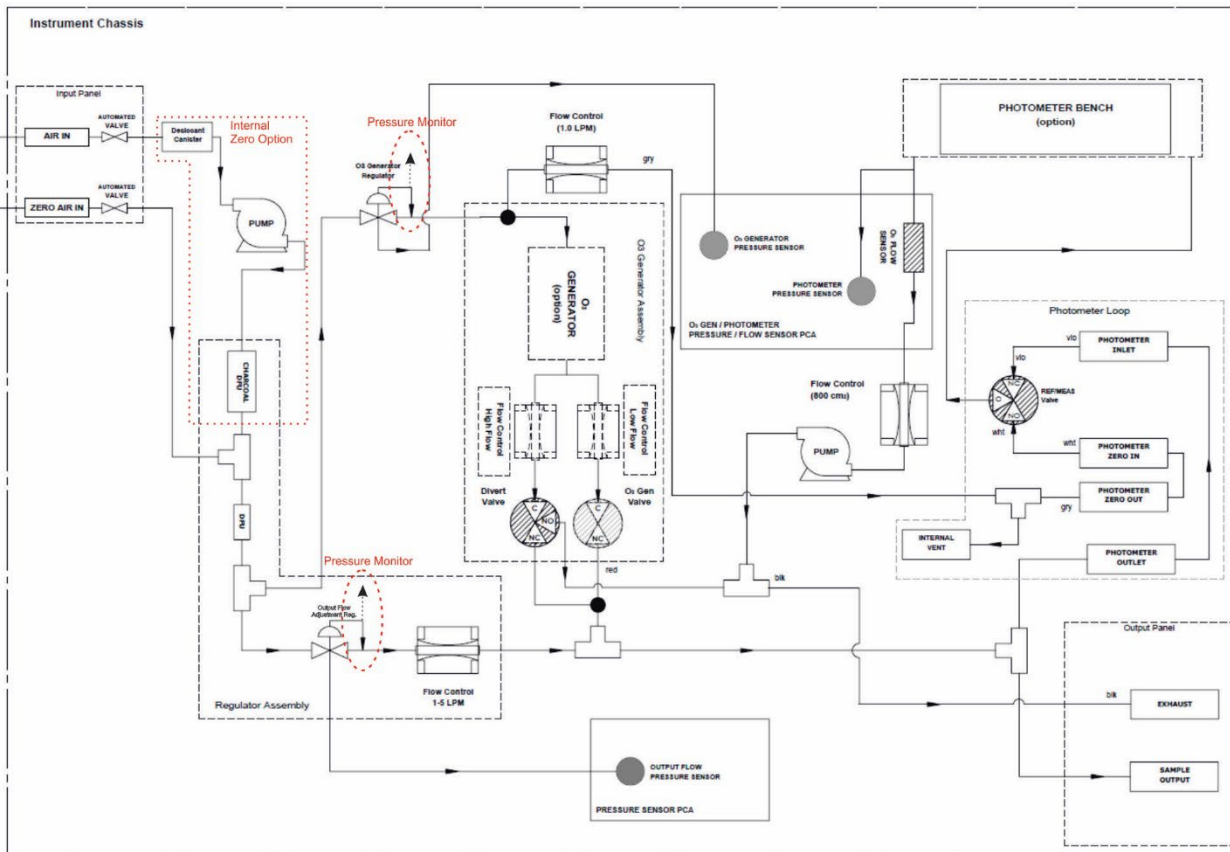

Figure 6-5: Pressure Calibration Monitor Points

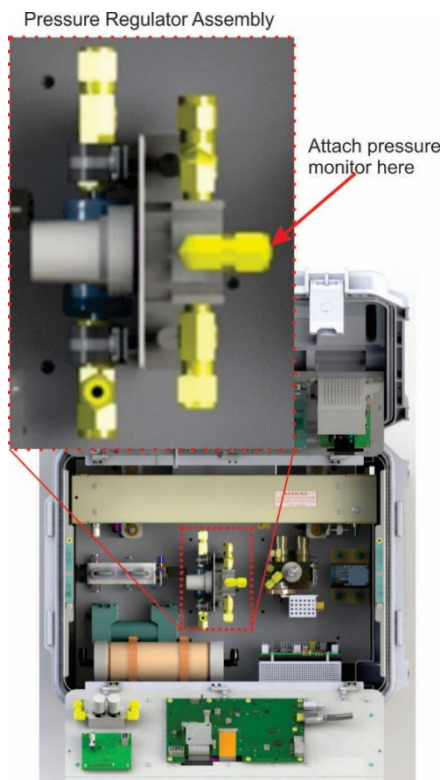
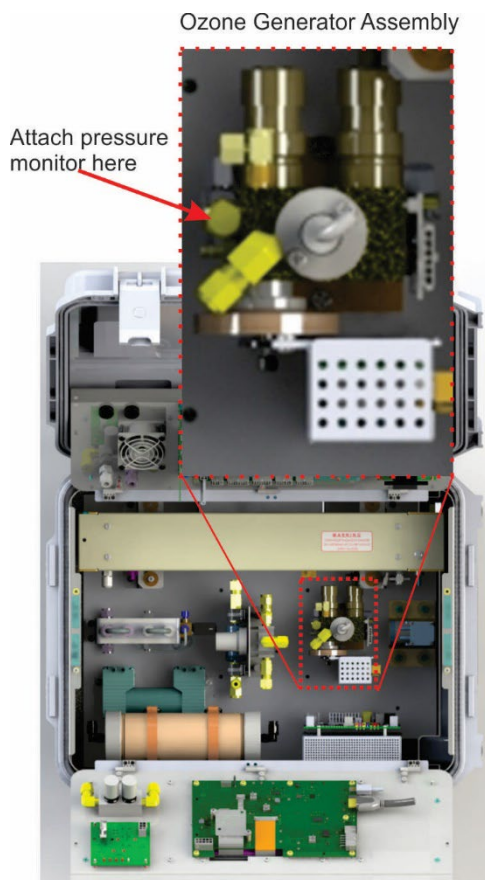

Figure 6-6: Pressure Regulator Monitor Connection Point



**Figure 6-7: O<sub>3</sub> Regulator Pressure Monitor Point**

### 6.3.2. CALIBRATING THE PRESSURE SENSORS

The following procedure requires a pump. If your unit does not have the internal pump option, temporarily connect an external pump.

1. Turn off the calibrator and open the top cover.
2. Connect a pressure meter to the Regulator Pressure measurement fitting (see Figure 6-6). This fitting is located on the backside of the regulator assembly.
3. Connect a pressure meter to the O<sub>3</sub> Regulator assembly (Figure 6-7).
4. Turn on the calibrator
5. Navigate to Utilities>Diagnostics>Pressure Cal menu.

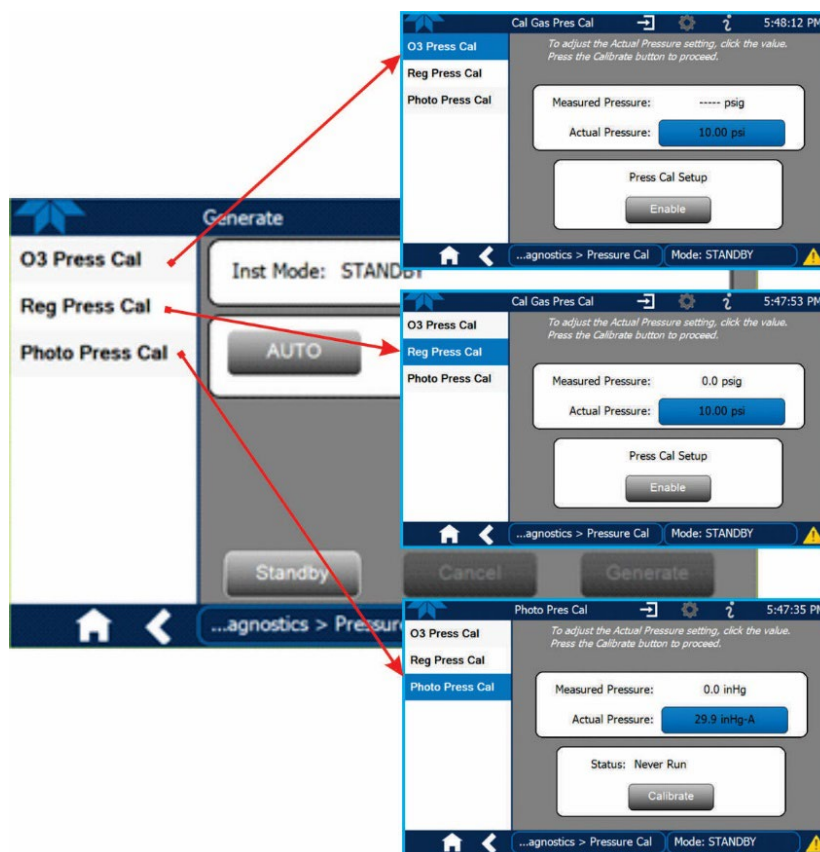

Figure 6-8: Pressure Ca

6. In each of the three pages, O3 Press Cal, Reg Press Cal, and Photo Press Cal, press the Actual Pressure button and input the value obtained from the corresponding pressure meter, and then press the Calibrate button.
7. Turn OFF the calibrator, remove the pressure monitor, and replace the cap on the pressure measurement fitting.

## 6.4. GAS FLOW CALIBRATION

The T753U has two gas flow characteristics that affect its performance: the flow of gas through the sample chamber of the instrument’s photometer and the total gas flow being output. While both are stored in the calibrator’s memory and used to compensate the final concentration calculations for changes in atmospheric pressure, they are calculated quite differently:

### CALCULATING THE PHOTOMETER SAMPLE GAS FLOW RATE

This flow rate is measured directly by a flow sensor located on the pressure / flow sensor PCA. A slope factor, stored in the calibrator’s memory the last time a **PHOTO FLOW** calibration operation (see Section 6.4.1) was performed, is applied to the reading from that sensor.

The measured photometer sample gas flow value is viewable in the Dashboard as **PHOTO FLOW** and can be output to the Data Logger (see Section 3.3.1 for configuration).



## CALCULATING THE OUTPUT GAS FLOW RATE

This flow rate is calculated by applying a separate slope factor, also stored in the calibrator's memory, to an interpolated value based on the following table of internal gas pressure as measured by the O<sub>3</sub> gas input pressure sensor. The output-flow slope value is determined by performing an **OUTPUT FLOW** calibration operation (see Section 6.4.2).

**Table 6-2: T753U Gas Pressure to Output Flow Conversions**

| REGULATOR PRESSURE TO OUTPUT FLOW |       |
|-----------------------------------|-------|
| PSIG                              | LPM   |
| 0.0                               | 0.000 |
| 1.0                               | 1.608 |
| 1.5                               | 2.139 |
| 2.0                               | 2.549 |
| 2.5                               | 3.033 |
| 3.0                               | 3.360 |
| 3.5                               | 3.712 |
| 4.0                               | 4.056 |
| 4.5                               | 4.392 |
| 5.0                               | 4.715 |
| 5.5                               | 5.051 |
| 6.0                               | 5.281 |
| 6.5                               | 5.609 |
| 7.0                               | 5.900 |
| 8.0                               | 6.467 |
| 9.0                               | 7.032 |
| 10.0                              | 7.558 |
| 11.0                              | 8.088 |
| 12.0                              | 8.626 |
| 13.0                              | 9.182 |
| 14.0                              | 9.715 |
| 15.0                              | 10.1  |
| 16.0                              | 10.6  |
| 17.0                              | 11.1  |
| 18.0                              | 11.7  |
| 19.0                              | 12.2  |
| 19.65                             | 12.4  |

The calculated **OUTPUT FLOW** value is viewable on the Dashboard page and can be output to the Data Logger (see Section 3.3.1 for configuration).

### 6.4.1. CALIBRATING THE PHOTOMETER'S SAMPLE GAS FLOW

**Note**

The procedure described in this section requires the output port of an external flow meter to be connected to the input of the photometer bench on the T753U.

During the **PHOTO FLOW** calibration, the T753U software automatically turns on the DC pump downstream from the photometer.

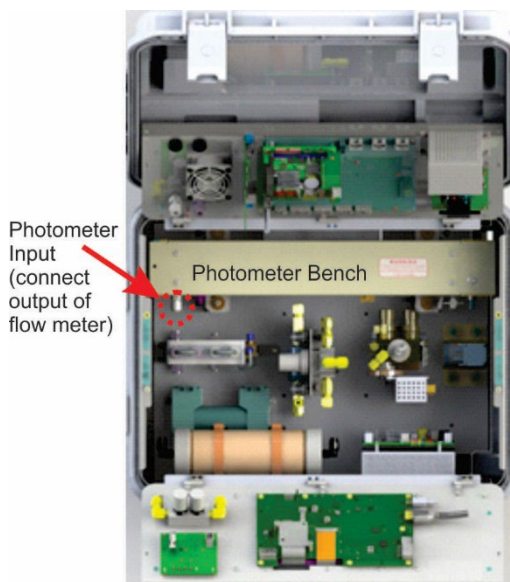

**Figure 6-9: Input Port of Photometer Bench**

To perform a **PHOTO FLOW** calibration:

1. Connect the external flow meter's **output** connection to the input of the photometer bench.
2. Navigate to the Utilities>Diagnostics>Photo Flow Cal page.

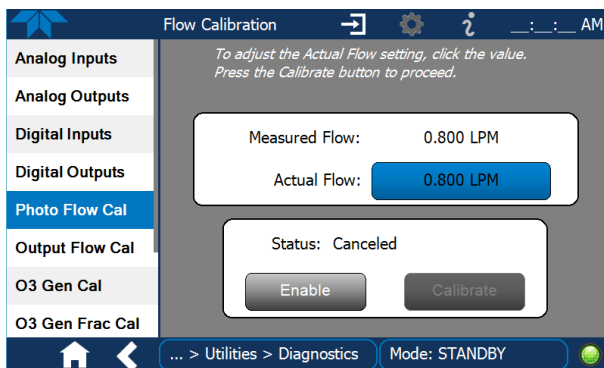

**Figure 6-10: Photometer Flow Calibration Page**

3. Press the Enable button and allow a few minutes for the external flow meter to stabilize.
4. Press the Actual Flow button and input the reading from the external flow meter.
5. Press the Calibrate button, which updates the measured flow within a few seconds.

## 6.4.2. CALIBRATING THE OUTPUT GAS FLOW

The procedure described in this section requires an independent, calibrated external flow meter.

To perform an Output Gas Flow:

1. Connect the external flow meter to the Cal Gas Out port.
2. Navigate to the Utilities>Diagnostics>Output Flow Cal page.

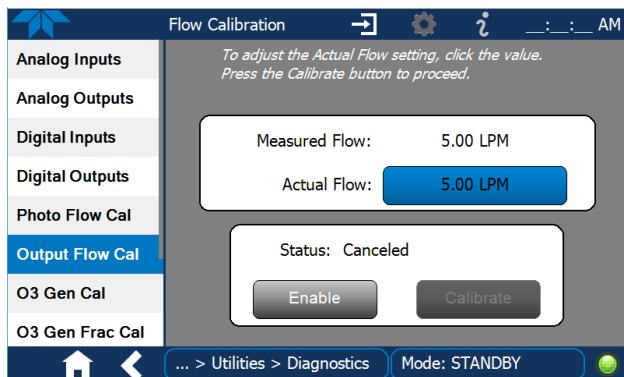

Figure 6-11: Output Gas Flow Calibration Page

3. Press the Enable button and allow a few minutes for flow on the external flow meter to stabilize.
4. Press the Actual Flow button and input the reading from the external flow meter.
5. Press the Calibrate button, which updates the measured flow within a few seconds.

## 6.5. ANALOG INPUT (AIN) CALIBRATION

The Utilities>Diagnostics>Analog Inputs menu is used to calibrate the instrument's A-to-D conversion circuitry. This calibration should only be necessary after a major repair such as replacement of CPU, motherboard or power supplies.

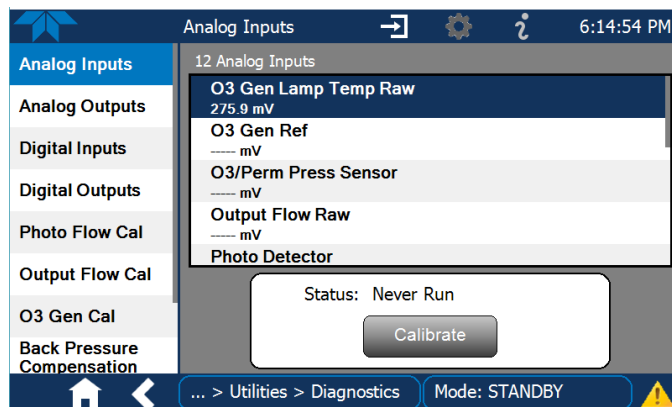

Figure 6-12: Analog Inputs Calibration Page

This page intentionally left blank.

....

## 7. MAINTENANCE AND SERVICE

Predictive diagnostic functions including failure warnings and alarms built into the calibrator's firmware allow the user to determine when repairs are necessary without performing painstaking preventative maintenance procedures.

For the most part, the T753U calibrator is maintenance free; there are, however, a minimal number of simple procedures that when performed regularly will ensure that the T753U photometer continues to operate accurately and reliably over its lifetime.

Troubleshooting and service are covered in Section 8 of this manual.

### 7.1. MAINTENANCE SCHEDULE

Table 7-1 below shows the recommended maintenance schedule for the T753U. Please note that in certain environments (i.e. dusty, very high ambient pollutant levels, temperatures, or humidity) some maintenance procedures may need to be performed more often than shown.

**Note**

**A Span and Zero Calibration Check must be performed following maintenance procedures specified (see CAL CHECK REQ'D Column of Table 8 1).**

**See Section 7.1 for instructions on performing a calibration check.**

#### WARNING – ELECTRICAL SHOCK HAZARD



**Disconnect power before performing any of the following operations that require entry into the interior of the Instrument.**



#### CAUTION – TECHNICIAN REQUIRED

**The operations outlined in this chapter are to be performed by qualified maintenance personnel only.**

This page intentionally left blank.

**Table 7-1: T753U Maintenance Schedule**

| ITEM                                       | ACTION                                                                                                         | FREQ                                        | CAL CHECK REQ'D.   | MANUAL SECTION | DATE PERFORMED                                                                                                                                                                             |  |  |  |  |  |  |  |  |  |
|--------------------------------------------|----------------------------------------------------------------------------------------------------------------|---------------------------------------------|--------------------|----------------|--------------------------------------------------------------------------------------------------------------------------------------------------------------------------------------------|--|--|--|--|--|--|--|--|--|
|                                            |                                                                                                                |                                             |                    |                |                                                                                                                                                                                            |  |  |  |  |  |  |  |  |  |
| Verify Test Functions                      | Record and analyze                                                                                             | Weekly or after any Maintenance or Repair   | No                 | 2.4.2          |                                                                                                                                                                                            |  |  |  |  |  |  |  |  |  |
| Photometer Pump Diaphragm                  | <b>No Replacement Required. Under Normal Circumstances the Pumps Will Last the Lifetime of the Instrument.</b> |                                             |                    |                |                                                                                                                                                                                            |  |  |  |  |  |  |  |  |  |
| Dry Air Pump Diaphragm                     | <b>No Replacement Required. Under Normal Circumstances the Pumps Will Last the Lifetime of the Instrument.</b> |                                             |                    |                |                                                                                                                                                                                            |  |  |  |  |  |  |  |  |  |
| Desiccant (dryer canister with silica gel) | Replace media                                                                                                  | As Needed                                   | No                 | 7.6            |                                                                                                                                                                                            |  |  |  |  |  |  |  |  |  |
| Absorption Tube                            | Inspect<br>---<br>Clean                                                                                        | As Needed                                   | Yes after cleaning | 7.5            | <b>Cleaning of the Photometer Absorption Tube Should Not Be Required as long as<br/>ONLY CLEAN, DRY, PARTICULATE FREE<br/>Zero Air (Diluent Gas)<br/>is used with the T753U Calibrator</b> |  |  |  |  |  |  |  |  |  |
| Perform Leak Check                         | Verify Leak Tight                                                                                              | Annually or after any Maintenance or Repair | No                 | 7.4            |                                                                                                                                                                                            |  |  |  |  |  |  |  |  |  |
| Pneumatic lines                            | Examine and clean                                                                                              | As needed                                   | Yes if cleaned     | ---            |                                                                                                                                                                                            |  |  |  |  |  |  |  |  |  |

This page intentionally left blank.



## 7.2. OPERATIONAL HEALTH CHECKS

Navigate to the **Utilities>USB Utilities>Report** menu (Figure 7-1) to download a report on the basic operations of the instrument. The report is generated every 24 hours to the Internet (the “cloud”) where it is available for viewing by Teledyne API technical support personnel. To download the report for your own viewing on a computer or to send to others, insert a flash drive into a front panel USB port and press the Download button, which is enabled when the instrument detects the flash drive.

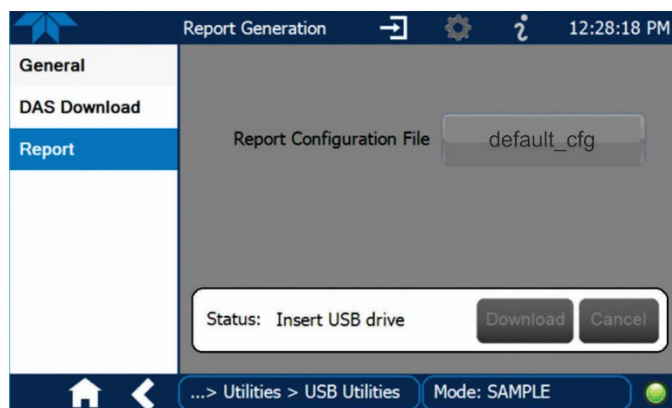

Figure 7-1: Report Generation Page

## 7.3. SOFTWARE/FIRMWARE UPDATES

There are two ways to check for and acquire updates: either remotely or manually.

### 7.3.1. REMOTE UPDATES

The instrument must be connected to a network that is connected to the Internet. In the Setup>Instrument menu>Remote Update menu press the Check for Updates button. If the Status field shows that an update is available, it can be downloaded through this page.

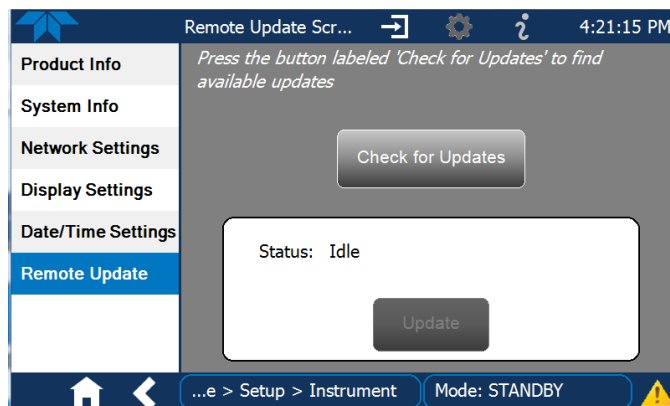
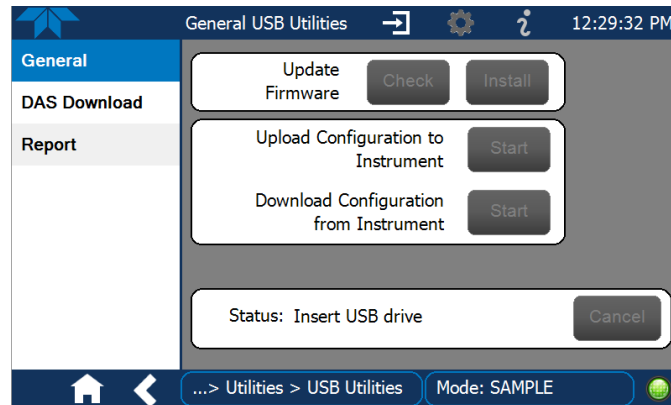

Figure 7-2: Remote Update Page

### 7.3.2. MANUAL RELOAD/UPDATE PROCEDURES

To reload or update firmware, first contact Technical Support to obtain the applicable file(s): [sda\\_techsupport@teledyne.com](mailto:sda_techsupport@teledyne.com) / 800-324-5190.

1. Follow Technical Support's instructions for copying the firmware files to a flash drive.
2. Navigate to the Utilities>USB Utilities>General menu.



**Figure 7-3: Manual Update Page (and other utilities)**

3. Insert a flash drive into a front panel USB port and wait for the Status field to indicate that the drive has been detected.
4. In the Update Firmware field, press the Check button for the instrument to determine whether the firmware on the flash drive is more recent than what is currently installed. Once it's been determined that the firmware is new, the Install button will be enabled; if the firmware version on the flash drive is the same as or older than the current firmware of the instrument, the Install button will not be enabled.
5. Press the Install button, and note the messages in the Status field at the bottom of the page. Use the Cancel button if necessary.
6. When complete, as indicated in the Status field, press the Done button, which replaces the Cancel button, and remove the flash drive.
7. Power off and restart the instrument to complete the new firmware installation.

## 7.4. PERFORMING LEAK CHECKS

Leaks are the most common cause of instrument malfunction. The leak-down rate should not exceed 1 in-Hg (0.4 PSI) in 5 minutes after the pressure is shut off. If leakage rate exceeds this, then perform the leak check procedure.

The following pressure leak check procedure can be used with either a leak checker, which contains a small pump, shut-off valve and pressure gauge (similar to the TAPI PN 01960) or a tank of pressurized gas, with the two-stage regulator adjusted to  $\leq 15$  psi, a shutoff valve and pressure gauge may be used.



### CAUTION – AVOID DAMAGE TO THE INSTRUMENT

**Once the fittings have been wetted with soap solution, do not apply a vacuum as this will cause soap solution to be drawn into the instrument, contaminating it.**

**Do not exceed 15 psi pressure.**

1. Place the calibrator in Standby mode and refer to Figure 7-4 and Figure 7-5 for pneumatic diagrams showing locations referenced herein.
2. Install a leak checker or tank of gas as described above on the front panel “ZERO AIR IN” port.
3. On the output panel install caps on the EXHAUST and CAL GAS OUT ports.

Due to normal internal leakage that occurs with pumps, they will need to be bypassed for the leak check:

4. Internally, install a cap on the internal vent that is located on the photometer loop assembly.
5. For instruments with the Zero Air Option, locate and isolate the internal zero air pump (if no Zero Air option, skip to Step 8).
  - a. Using 1/4” tubing with one end having a 1/4” Tube female fitting, bypass the internal zero air pump by connecting the output of the desiccant canister to the inlet of the charcoal filter that is located on the regulator assembly.
6. Gather two small clamps and locate and isolate the photometer pump:
  - a. Use one clamp to clamp upstream of the flowmeter sensor on the Pressure/Flow PCA located above the photometer.
  - b. Use the other to clamp downstream of the photometer pump.
7. Activate the Zero Air Shutoff Valve (in the Utilities>Diagnostics>Digital Outputs menu, scroll to Zero Air Shutoff Valve and select the OFF button, which changes to ON state).
8. WITHOUT exceeding 15 PSIG, pressurize the calibrator using either the leak checker or the tank – *without exceeding 15 psi pressure*, allowing enough time to pressurize the instrument fully.

9. After about 3 minutes to allow for the instrument to completely pressurize, Check each fitting with soap bubble solution, and look for expanding bubbles, which indicates a leak. (*Do not reapply vacuum as doing so will draw soap solution into the instrument and contaminate it*).
10. Once the leak has been located and repaired, use a clean, absorbent cloth to *thoroughly* remove any residual soap solution from the instrument interior *before* turning on the instrument.

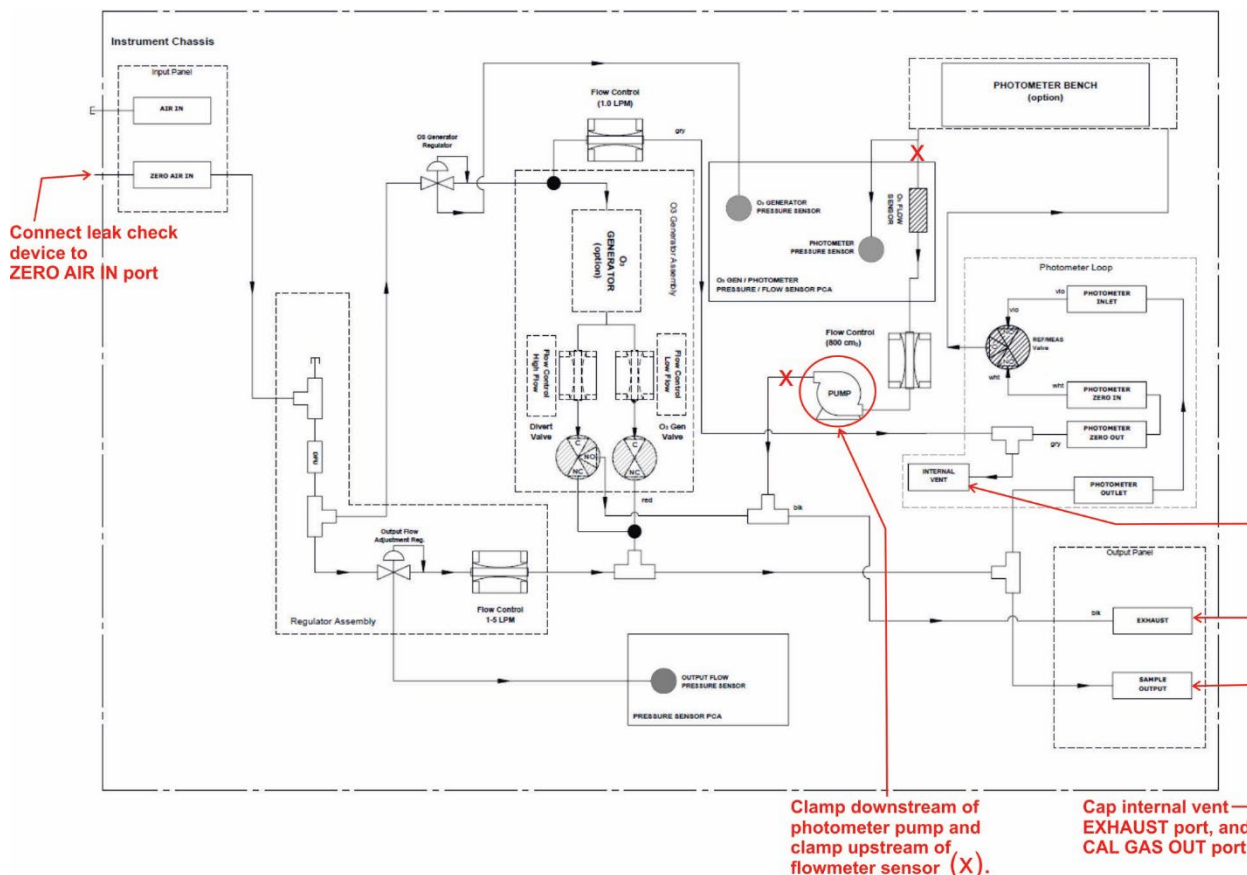

Figure 7-4: Leak Check Setup, Basic Pneumatics

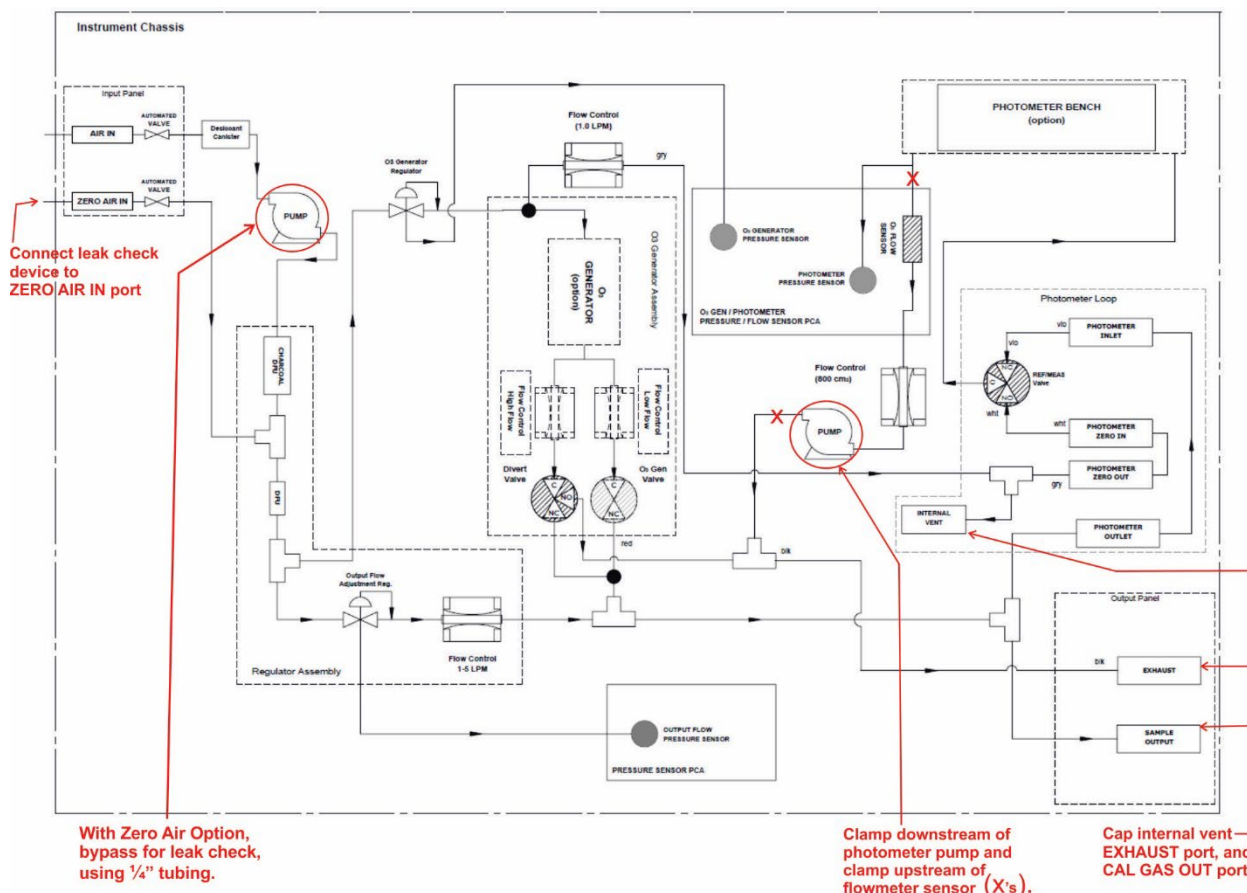

Figure 7-5: Leak Check Setup, with Internal Zero Air Option

## 7.5. CLEANING OR REPLACING THE ABSORPTION TUBE

**Note**

Although this procedure should never be needed as long as the user is careful only to supply the photometer with clean, dry and particulate free zero air, it is included here for those rare occasions when cleaning or replacing the absorption tube may be required.

1. Remove the center cover from the optical bench.  
 Unclip the sample thermistor from the tube.  
 Loosen the two screws on the round tube retainers at either end of the tube.  
 Using both hands, carefully rotate the tube to free it.  
 Slide the tube towards the lamp housing.
  - The front of the tube can now be slid past the detector block and out of the instrument.

**CAUTION – Avoid Damage to the Instrument**



**Do not cause or allow the tube to bind against the metal housings. The tube may break and cause serious injury.**

2. Clean the tube with Distilled or de-ionized water by running a swab from end-to-end.
3. Air-dry the tube.
4. Check the cleaning job by looking down the bore of the tube.
  - It should be free from dirt and lint.
5. Inspect the o-rings that seal the ends of the optical tube (these o-rings may stay seated in the manifolds when the tube is removed.)
  - If there is any noticeable damage to these o-rings, they should be replaced.
6. Re-assemble the tube into the lamp housing and perform a leak check (Section 7.4) on the instrument.

**Note**

**For correct alignment, ensure that the tube is pushed all the way to the front of the optical bench when it is re-assembled, so that the tube is snug against the stop inside the detector manifold**

## 7.6. ASSESSING USAGE OF AND REPLACING DESICCANT (SILICA GEL)

A freshly charged T753U dryer canister can output dry air with dew point  $-20\text{ }^{\circ}\text{C}$  or lower. The frequency of replacing the desiccant in the dryer canister is dependent on time, flow rate, and level of environmental humidity. Due to the variability of humidity, there is no accurate way to know precisely when to replace the desiccant other than the empirical signs of color change from a rich golden color to pale; however, it is possible to configure the desiccant setting to an artificial volume that's based on the relative humidity in which the calibrator is operating, such that the software calculates a virtually realistic usage rate and provides an Alert when it is time to replace the desiccant.

Navigate to the Setup>Vars menu and set the Desiccant Max value according to Table 7-2 using the relative humidity (RH%) corresponding to that of the environment in which the calibrator is operating. (This table also provides an estimated number of hours that the desiccant may last, which was reached while testing in an environment of  $22\text{ }^{\circ}\text{C}$  ambient temperature at an average flow rate of 5 LPM). The software uses this artificial value along with time and flow rate to calculate the usage (see Desiccant Used parameter in the Dashboard), and to trigger an Alert when the Desiccant Max value is reached.

Periodically checking the actual color of the desiccant against the Desiccant Used in the Dashboard will help to determine whether to adjust the Desiccant Max Var at the next change of desiccant.

**Table 7-2. Desiccant Usage Estimates at 5 LPM Flow**

| RH% | VALUE TO INPUT FOR DESICCANT MAX VAR (LITERS) | PROJECTED USAGE TIME (HRS) |
|-----|-----------------------------------------------|----------------------------|
| 30  | 3600                                          | 12                         |
| 40  | 3000                                          | 10                         |
| 50  | 2400                                          | 8                          |
| 60  | 1800                                          | 6                          |
| 70  | 1200                                          | 4                          |
| 80  | 600                                           | 2                          |
| 90  | 300                                           | <1                         |

When changing the desiccant, a mask is recommended to avoid inhaling any fine dust; the procedure is as follows:

1. Turn off the power and wait for the pressure to go to zero.
2. On both ends of the canister, compress the plastic ring of the quick release fittings to unlatch and remove the inlet/outlet tubes.
3. Remove canister from the two fastening straps.
4. On spring end of canister, carefully unscrew lid with control to prevent sudden release of spring.
5. Remove the spring, noting how it fits the metal grate, then remove the metal grate, and the filter from the canister.
6. Dispose of the used silica gel in accordance with local regulation. (It is also possible to recharge the silica gel; please contact Technical Support for information).
7. Refill the canister with a new batch of silica gel.
8. Return the filter first, then the metal grate, ensuring the same orientation as previously noted, and the spring to the canister in same order.
9. Screw lid back onto the canister.
10. Set the canister back in place and secure with fastening straps.
11. Reattach the tubes, seating them in the fittings such that they click into place.
12. Power on the instrument.
13. Navigate to the Setup>Vars menu and either edit the Max Desiccant value or leave as is if the Desiccant Used appeared to be correct.
14. Also in the Setup>Vars menu, select Desiccant Replace Trigger, press the Edit button, select RESET and press the Done button. (This resets the Desiccant Used parameter back to 0.00 Liters).

## 7.7. ADJUSTING THE PHOTOMETER UV SOURCE LAMP

This procedure details the steps for adjustment of the UV source lamp in the optical bench assembly. This procedure should be done whenever the **O3 REF** value drops below 3000 mV.

1. Make sure the instrument is warmed-up and has been running in Standby mode for at least 15 minutes before proceeding.
2. Open the instrument panels.
3. Locate the Photometer.
4. Locate the UV DETECTOR GAIN ADJUST POT on the photometer assembly (see Figure 7-6).
5. Navigate to the Utilities>Diagnostics>Analog Inputs menu and select Photo Detector.
6. Using an insulated pot adjustment tool, Turn the UV DETECTOR GAIN ADJUSTMENT POT until the value of Photo Detector is as close as possible to 4600.0 MV.
  - Additional adjustment can be made by physically rotating the lamp in its housing. To do this, slightly loosen the UV lamp setscrew and slowly rotate the lamp up to ¼ turn in either direction while watching the **Photo Detector** signal.
  - Once the optimum lamp position is determined, re-tighten the lamp setscrew.

If a minimum reading of 3500.0 mV cannot be reached, the lamp must be replaced.

Replace the cover on the instrument.

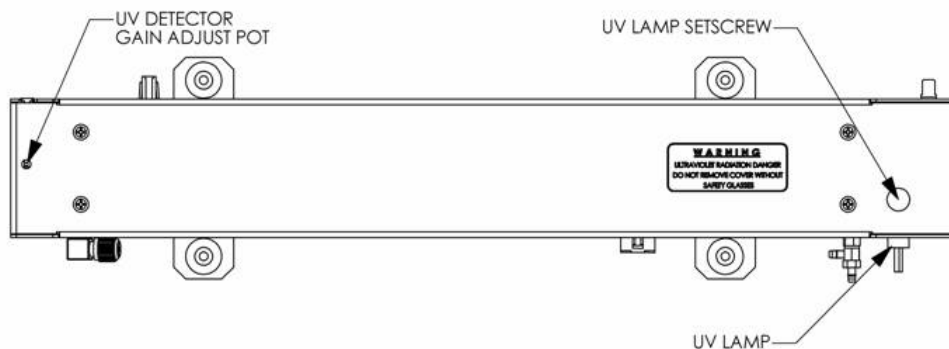

Figure 7-6: Photometer – Location of UV Detector Gain Adjustment & UV Lamp Set Screw



## 7.8. REPLACING THE PHOTOMETER UV SOURCE LAMP

This procedure details the steps for replacement of the UV source lamp in the optical bench assembly. This procedure should be done whenever the lamp can no longer be adjusted as described in Section 7.7.

1. Turn the instrument off.
2. Remove the cover from the instrument.
3. Locate the Optical Bench Assembly.
4. Locate the UV lamp at the rear of the optical bench assembly (see Figure 7-6)
5. Unplug the lamp cable from the power supply connector on the side of the optical bench.
6. Slightly loosen (do not remove) the UV lamp setscrew and pull the lamp from its housing.

**Note**

**The UV lamp contains mercury (Hg), which is considered hazardous waste. The lamp should be disposed of in accordance with local regulations regarding waste containing mercury.**

7. Install the new lamp in the housing, pushing it all the way in. Leave the UV lamp setscrew loose for now.
8. Turn the instrument back on and allow it to warm up for at least 15 minutes.
9. Turn the UV detector gain adjustment pot (see Figure 7-6) clockwise to its minimum value. The pot should click softly when the limit is reached.
10. Perform the UV Lamp Adjustment procedure described in Section 7.7, with the following exceptions:
11. Slowly rotate the lamp in its housing (up to  $\frac{1}{4}$  turn in either direction) until a **maximum** value (or 4600 mVDC) is observed.
  - Make sure the lamp is pushed all the way into the housing while performing this rotation.
  - If the Photo Detector will not drop below 5000 mV while performing this rotation, contact TAPI Technical Support for assistance.
12. Once a lamp position is found that corresponds to a maximum observed value for Photo Detector, tighten the lamp setscrew at the approximate maximum value observed.
  - If the value of Photo Detector is not within the range of 4400 – 4600 mV, adjust it accordingly.
13. Close the instrument panels.

## 7.9. ADJUSTING OR REPLACING THE OZONE GENERATOR UV LAMP

This procedure details the steps for replacement and initial adjustment of the ozone generator lamp. If you are adjusting an existing lamp, skip to Step 8.

1. Turn off the instrument.
2. Open the instrument panels.
3. Locate the O<sub>3</sub> generator.

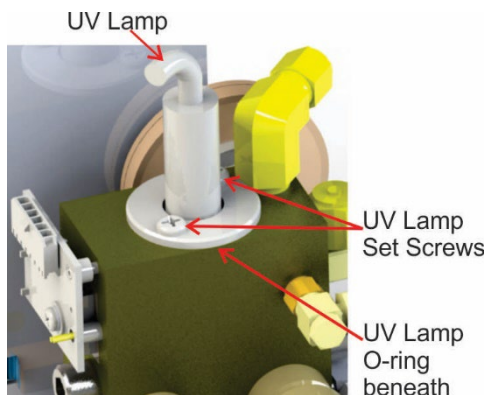

**Figure 7-7: O<sub>3</sub> Generator UV Lamp Location**

4. Remove the two setscrews on the top of the O<sub>3</sub> generator and gently pull out the old lamp.
5. Inspect the o-ring beneath the UV lamp retaining ring and replace if damaged.
6. Install the new lamp in O<sub>3</sub> generator housing, ensuring that it is fully seated.
7. Tighten the two set screws.
8. Turn on instrument and allow it to stabilize for at least 30 minutes.
9. Replace the calibrator's cover
10. Perform a leak check (Section 7.4).
11. Calibrate the Ozone Generator (see Section 6.2).

## 8. GENERAL TROUBLESHOOTING & SERVICE

This section contains a variety of methods for identifying and solving performance problems with the calibrator.



### CAUTION – TECHNICIAN REQUIRED

The operations outlined in this chapter are to be performed by qualified maintenance personnel only.



### WARNING – ELECTRICAL SHOCK HAZARD

- Risk of electrical shock. Some operations need to be carried out with the instrument open and running.
- Exercise caution to avoid electrical shocks and electrostatic or mechanical damage to the calibrator.
- Do not drop tools into the calibrator or leave those after your procedures.
- Do not shorten or touch electric connections with metallic tools while operating inside the calibrator.
- Use common sense when operating inside a running calibrator.

### 8.1. GENERAL TROUBLESHOOTING

The T753U Portable Calibrator has been designed so that problems can be rapidly detected, evaluated and repaired. During operation, it continuously performs diagnostic tests and provides the ability to evaluate its key operating parameters without disturbing monitoring operations.

A systematic approach to troubleshooting will generally consist of the following five steps:

1. Note any warning messages in the Alerts page and take corrective action as necessary.
2. Examine the values of functions and compare them to factory values. Note any major deviations from the factory values and take corrective action.
3. Use the internal electronic status LEDs to determine whether the electronic communication channels are operating properly.
  - Verify that the DC power supplies are operating properly by checking the voltage test points on the power distribution board. (The calibrator's DC power wiring is color-coded and these colors match the color of the corresponding test points on the power distribution board).
4. Suspect a leak first!
  - Technical Support data indicate that the majority of all problems are eventually traced to leaks in the internal pneumatics of the calibrator or the diluent gas and source gases delivery systems.
  - Check for gas flow problems such as clogged or blocked internal/external gas lines, damaged seals, punctured gas lines, a damaged / malfunctioning pumps, etc.
5. Refer to the Dashboard to confirm that the calibrator's vital functions are working properly.

### 8.1.1. FAULT DIAGNOSIS WITH MESSAGES IN THE ALERTS PAGE

The most common and/or serious instrument failures will result in a warning message being displayed in the Alerts page. Table 8-1 lists possible Alerts, along with their meaning and recommended corrective action.

It should be noted that more than two or three warning messages occurring at the same time is often an indication that some fundamental sub-system (power supply, power distribution board, motherboard) has failed rather than an indication of the specific failures referenced by the warnings. In this case, it is recommended that proper operation of power supplies (see Section 8.4.3), the power distribution board (see Section 9.2.3), and the motherboard (see Section 8.4.8) be confirmed before addressing the specific warning messages.

**Table 8-1: Possible Alerts**

| MESSAGE                             | FAULT CONDITION                                                                                                            | POSSIBLE CAUSES                                                                                                                                                                                                                                                                                                                                        |
|-------------------------------------|----------------------------------------------------------------------------------------------------------------------------|--------------------------------------------------------------------------------------------------------------------------------------------------------------------------------------------------------------------------------------------------------------------------------------------------------------------------------------------------------|
| <b>CONFIG INITIALIZED</b>           | Configuration and Calibration data reset to original Factory state.                                                        | <ul style="list-style-type: none"> <li>- Failed Disk on Chip</li> <li>- User has erased configuration data</li> </ul>                                                                                                                                                                                                                                  |
| <b>DATA INITIALIZED</b>             | Data Storage in DAS was erased.                                                                                            | <ul style="list-style-type: none"> <li>- Failed Disk-on-Module.</li> <li>- User cleared data.</li> </ul>                                                                                                                                                                                                                                               |
| <b>LAMP DRIVER WARN</b>             | The CPU is unable to communicate with either the O <sub>3</sub> generator or photometer lamp I <sup>2</sup> C driver chip. | <ul style="list-style-type: none"> <li>- I<sup>2</sup>C has failed</li> </ul>                                                                                                                                                                                                                                                                          |
| <b>O3 GEN LAMP TEMP WARNING</b>     | IZS Ozone Generator Temp is outside of control range of 48°C ± 3°C.                                                        | <ul style="list-style-type: none"> <li>- No IZS option installed, instrument improperly configured</li> <li>- O<sub>3</sub> generator heater</li> <li>- O<sub>3</sub> generator temperature sensor</li> <li>- Relay controlling the O<sub>3</sub> generator heater</li> <li>- Entire Power distribution board</li> <li>- I<sup>2</sup>C Bus</li> </ul> |
| <b>O3 PUMP WARNING<sup>1</sup></b>  | The photometer pump failed to turn on within the specified timeout period (default = 30 sec.).                             | <ul style="list-style-type: none"> <li>- Failed Pump</li> <li>- Problem with Power distribution board</li> <li>- 12 VDC power supply problem</li> </ul>                                                                                                                                                                                                |
| <b>PHOTO LAMP TEMP WARNING</b>      | The photometer lamp temp is outside range limits.                                                                          | Possible failure of: <ul style="list-style-type: none"> <li>- Bench lamp heater</li> <li>- Bench lamp temperature sensor</li> <li>- Relay controlling the bench heater</li> <li>- Entire Power distribution board</li> <li>- I<sup>2</sup>C Bus</li> <li>- Hot Lamp</li> </ul>                                                                         |
| <b>PHOTO LAMP STABILITY WARNING</b> | Value output during the Photometer's reference cycle changes from measurement to measurement more than 25% of the time.    | <ul style="list-style-type: none"> <li>- Faulty UV source lamp</li> <li>- Noisy UV detector</li> <li>- Faulty UV lamp power supply</li> <li>- Faulty ± 15 VDC power supply</li> </ul>                                                                                                                                                                  |
| <b>PHOTO REFERENCE WARNING</b>      | Occurs when Ref is <2500 mVDC or >4950 mVDC.                                                                               | Possible failure of: <ul style="list-style-type: none"> <li>- UV Lamp</li> <li>- UV Photo-Detector Preamp</li> </ul>                                                                                                                                                                                                                                   |
| <b>REAR BOARD NOT DET</b>           | Motherboard not detected on power up.                                                                                      | <ul style="list-style-type: none"> <li>- THIS WARNING only appears on Serial I/O COM Port(s) Input and Control Panel Display will be frozen, blank or will not respond.</li> <li>- Failure of Motherboard</li> </ul>                                                                                                                                   |

| MESSAGE                              | FAULT CONDITION                                               | POSSIBLE CAUSES                                                                                                                                                                                                                                                            |
|--------------------------------------|---------------------------------------------------------------|----------------------------------------------------------------------------------------------------------------------------------------------------------------------------------------------------------------------------------------------------------------------------|
| <b>POWER DISTRIBUTION BOARD WARN</b> | The CPU cannot communicate with the Power distribution board. | <ul style="list-style-type: none"> <li>- I<sup>2</sup>C Bus failure</li> <li>- Failed power distribution board</li> <li>- Loose connectors/wiring</li> </ul>                                                                                                               |
| <b>SYSTEM RESET</b>                  | The computer has rebooted.                                    | <ul style="list-style-type: none"> <li>- This message occurs at power on.</li> <li>- If it is confirmed that power has not been interrupted:</li> <li>- Failed +5 VDC power</li> <li>- Fatal error caused software to restart</li> <li>- Loose connector/wiring</li> </ul> |

### 8.1.2. FAULT DIAGNOSIS WITH DASHBOARD FUNCTIONS

In addition to being useful predictive diagnostic tools, the functions viewable from the Dashboard menu can be used to isolate and identify many operational problems when combined with a thorough understanding of the calibrator's Theory of Operation (see Section 9).

The acceptable ranges for these functions are listed in the "Nominal Range" column of the calibrator Final Test and Validation Data Sheet shipped with the instrument. Values outside these acceptable ranges indicate a failure of one or more of the calibrator's subsystems. Functions whose values are still within the acceptable range but have significantly changed from the measurement recorded on the factory data sheet may also indicate a failure.

Table 8-2 contains some of the more common causes for these values to be out of range.

**Table 8-2: Dashboard Functions (Tags) - Indicated Failures**

| FUNCTION                           | DIAGNOSTIC RELEVANCE AND CAUSES OF FAULT CONDITIONS.                                                                                                                                                                                                                                                                             |
|------------------------------------|----------------------------------------------------------------------------------------------------------------------------------------------------------------------------------------------------------------------------------------------------------------------------------------------------------------------------------|
| <b>Output Flow</b>                 | <p>Gas flow problems directly affect the concentration accuracy of the O<sub>3</sub> calibration gases. This number is computed using data from the calibrator's</p> <ul style="list-style-type: none"> <li>- Check for Gas Flow problems.</li> <li>- Check the pressure regulator</li> </ul>                                    |
| <b>O<sub>3</sub> Gen Drive</b>     | <p>Check the O<sub>3</sub> generator heater and temperature sensors<br/>Possible causes of faults are the same as <b>O<sub>3</sub> GEN LAMP TEMP WARNING</b> from Table 8-1</p>                                                                                                                                                  |
| <b>O<sub>3</sub> Gen Lamp Temp</b> | <p>Incorrect Lamp temperature can affect the efficiency and durability of the O<sub>3</sub> generators UV lamp.<br/>Possible causes of faults are the same as <b>O<sub>3</sub> GEN LAMP TEMP WARNING</b> from Table 8-1</p>                                                                                                      |
| <b>Regulator Pressure</b>          | Same as <b>REGULATOR PRESSURE WARNING</b> from Table 8-1                                                                                                                                                                                                                                                                         |
| <b>Box Temp</b>                    | <p>If the Box Temperature is out of range (Box Temperature typically runs ~7°C warmer than ambient temperature), make sure that:</p> <ul style="list-style-type: none"> <li>- The Exhaust-Fan is running.</li> <li>- There is sufficient open space to the side and rear of instrument to allow adequate ventilation.</li> </ul> |

| FUNCTION                           | DIAGNOSTIC RELEVANCE AND CAUSES OF FAULT CONDITIONS.                                                                                                                                                                                                                                                                                                                                                                                                                                                                                                                                                                                                                                                                                                                                      |
|------------------------------------|-------------------------------------------------------------------------------------------------------------------------------------------------------------------------------------------------------------------------------------------------------------------------------------------------------------------------------------------------------------------------------------------------------------------------------------------------------------------------------------------------------------------------------------------------------------------------------------------------------------------------------------------------------------------------------------------------------------------------------------------------------------------------------------------|
| <p><b>O3 Meas &amp; O3 Ref</b></p> | <p>If the value displayed is too high the UV Source has become brighter. Adjust the variable gain potentiometer on the UV Preamp Board in the optical bench.</p> <p>If the value displayed is too low:</p> <ul style="list-style-type: none"> <li>- &lt; 100mV – Bad UV lamp or UV lamp power supply.</li> <li>- &lt; 2000mV – Lamp output has dropped, adjust UV Preamp Board or replace lamp.</li> </ul> <p>If the value displayed is constantly changing:</p> <ul style="list-style-type: none"> <li>- Bad UV lamp.</li> <li>- Defective UV lamp power supply.</li> <li>- Failed I<sup>2</sup>C Bus.</li> </ul> <p>If the O3 Ref value changes by more than 10mV between zero and span gas:</p> <ul style="list-style-type: none"> <li>- Defective/leaking switching valve.</li> </ul> |
| <p><b>Photo Flow</b></p>           | <p>Gas flow problems directly affect the accuracy of the photometer measurements and therefore the concentration accuracy of cal gas mixtures.</p> <ul style="list-style-type: none"> <li>- Check for Gas Flow problems.</li> </ul>                                                                                                                                                                                                                                                                                                                                                                                                                                                                                                                                                       |
| <p><b>Photo Lamp Temp</b></p>      | <p>Poor photometer temp control can cause instrument noise, instability and drift. Temperatures outside of the specified range or oscillating temperatures are cause for concern. Possible causes of faults are the same as <b>PHOTO LAMP TEMP WARNING</b> from Table 8-1</p>                                                                                                                                                                                                                                                                                                                                                                                                                                                                                                             |
| <p><b>O3 Press</b></p>             | <p>The pressure of the gas in the photometer's sample chamber is used to calculate the concentration of O<sub>3</sub> in the gas stream. Incorrect sample pressure can cause inaccurate readings.</p> <ul style="list-style-type: none"> <li>- Check for Gas Flow problems. See Section Table 8-1.</li> </ul>                                                                                                                                                                                                                                                                                                                                                                                                                                                                             |
| <p><b>Sample Temp</b></p>          | <p>The temperature of the gas in the photometer's sample chamber is used to calculate the concentration of O<sub>3</sub> in the gas stream. Incorrect sample temperature can cause inaccurate readings.</p> <p>Possible causes of faults are:</p> <ul style="list-style-type: none"> <li>- Bad bench lamp heater</li> <li>- Failed sample temperature sensor</li> <li>- Failed relay controlling the bench heater</li> <li>- Failed Power distribution board</li> <li>- I<sup>2</sup>C Bus malfunction</li> <li>- Hot Lamp</li> </ul>                                                                                                                                                                                                                                                     |
| <p><b>O3 Slope</b></p>             | <p>Values outside range indicate:</p> <p>Contamination of the Zero Air or Span Gas supply.</p> <p>Instrument is miss-calibrated.</p> <p>Blocked Gas Flow.</p> <p>Faulty Sample Pressure Sensor or circuitry.</p> <p>Bad/incorrect Span Gas concentration.</p>                                                                                                                                                                                                                                                                                                                                                                                                                                                                                                                             |
| <p><b>O3 Offset</b></p>            | <p>Values outside range indicate:</p> <p>Contamination of the Zero Air supply.</p>                                                                                                                                                                                                                                                                                                                                                                                                                                                                                                                                                                                                                                                                                                        |

### 8.1.3. USING THE DIAGNOSTIC ANALOG INPUTS FUNCTION

The Analog Inputs found under the Utilities>Diagnostics menu combined with a thorough understanding of the instrument's Theory of Operation (Section 9) are useful for troubleshooting in that the technician can view the raw, unprocessed signal level of the calibrator's critical inputs and outputs. Ensure that the instrument is in Standby mode (under Home>Generate).

## 8.2. USING THE SIGNAL OUTPUTS FOR DIAGNOSTICS

The signals available for output over the Analog Output channel can also be used as diagnostic tools. See Section 3.3.9 for instruction on activating the analog output and selecting a function.

**Table 8-3: Signal Outputs as Diagnostic Tools**

| FUNCTION                | DESCRIPTION                                                 | ZERO                   | FULL SCALE                         | CAUSES OF EXTREMELY HIGH / LOW READINGS                                                                                                                                                                                                                                                                                                                                                                                                                                                                                                         |
|-------------------------|-------------------------------------------------------------|------------------------|------------------------------------|-------------------------------------------------------------------------------------------------------------------------------------------------------------------------------------------------------------------------------------------------------------------------------------------------------------------------------------------------------------------------------------------------------------------------------------------------------------------------------------------------------------------------------------------------|
| <b>O3 Meas</b>          | The raw output of the photometer during its measure cycle   | 0 mV                   | 5000 mV                            | <p>If the value displayed is:</p> <ul style="list-style-type: none"> <li>- &gt;5000 mV: The UV source has become brighter. Adjust the UV Detector Gain potentiometer.</li> <li>- &lt; 100mV – Bad UV lamp or UV lamp power supply.</li> <li>- &lt; 2000mV – Lamp output has dropped, adjust UV Preamp Board or replace lamp.</li> </ul> <p>If the value displayed is constantly changing:</p> <ul style="list-style-type: none"> <li>- Bad UV lamp.</li> <li>- Defective UV lamp power supply.</li> <li>- Failed I<sup>2</sup>C Bus.</li> </ul> |
| <b>O3 Ref</b>           | The raw output of the photometer during its reference cycle | 0 mV                   | 5000 mV                            | <p>If the O3 Ref value changes by more than 10mV between zero and span gas:</p> <ul style="list-style-type: none"> <li>- Defective/leaking M/R switching valve.</li> </ul>                                                                                                                                                                                                                                                                                                                                                                      |
| <b>Output Flow</b>      | Output flow rate (computed from regulator pressure).        | 0 LPM                  | 5 LPM (w/IZS)<br>15 LPM (w/ext.ZS) | <p>Gas flow problems directly affect the concentration accuracy of the O<sub>3</sub> calibration gases. This number is computed using data from the calibrator's</p> <ul style="list-style-type: none"> <li>- Check for Gas Flow problems.</li> <li>- Check the pressure regulator</li> </ul>                                                                                                                                                                                                                                                   |
| <b>Photo Pressure</b>   | The pressure of gas in the photometer absorption tube       | 0 In-Hg-A              | 40 In-Hg-A                         | Check for Gas Flow problems.                                                                                                                                                                                                                                                                                                                                                                                                                                                                                                                    |
| <b>Photo Flow</b>       | The gas flow rate through the photometer                    | 0 cm <sup>3</sup> /min | 1000 cc/m                          | Check for Gas Flow problems.                                                                                                                                                                                                                                                                                                                                                                                                                                                                                                                    |
| <b>Sample Temp</b>      | The temperature of gas in the photometer absorption tube    | 0 °C                   | 70 °C                              | Possible causes of faults are the same as <b>PHOTO STEMP</b> from Table 8-2                                                                                                                                                                                                                                                                                                                                                                                                                                                                     |
| <b>Photo Lamp Temp</b>  | The temperature of the photometer UV lamp                   | 0 °C                   | 70 °C                              | <p>Possible failure of:</p> <ul style="list-style-type: none"> <li>- Bench lamp heater</li> <li>- Bench lamp temperature sensor</li> <li>- Relay controlling the bench heater</li> <li>- Entire Power distribution board</li> <li>- I<sup>2</sup>C Bus</li> <li>- Hot" Lamp</li> </ul>                                                                                                                                                                                                                                                          |
| <b>O3 Gen Lamp Temp</b> | The temperature of the O <sub>3</sub> generator's UV lamp   | 0 mV                   | 5000 mV                            | Same as <b>PHOTO LAMP TEMP WARNING</b> from Table 8-1                                                                                                                                                                                                                                                                                                                                                                                                                                                                                           |
| <b>Box Temp</b>         | The temperature inside the chassis                          | 0 °C                   | 70 °C                              | <p>If the Box Temperature is out of range (Box Temperature typically runs ~7°C warmer than ambient temperature), make sure that:</p> <ul style="list-style-type: none"> <li>- the Exhaust-Fan is running.</li> <li>- there is sufficient open space to the side and rear of instrument to allow adequate ventilation.</li> </ul>                                                                                                                                                                                                                |

| FUNCTION  | DESCRIPTION                                                                   | ZERO | FULL SCALE | CAUSES OF EXTREMELY HIGH / LOW READINGS                                                                                                                                                                                                                                                                                                                                                                                                                                                 |
|-----------|-------------------------------------------------------------------------------|------|------------|-----------------------------------------------------------------------------------------------------------------------------------------------------------------------------------------------------------------------------------------------------------------------------------------------------------------------------------------------------------------------------------------------------------------------------------------------------------------------------------------|
| O3 Actual | The current concentration of O <sub>3</sub> being measured by the photometer. |      | ---        | <ul style="list-style-type: none"> <li>- I<sup>2</sup>C Bus malfunction</li> <li>- Gas flow problem through the photometer.</li> <li>- Electronic failure of the photometer subsystems</li> <li>- Failure or pressure / temperature sensors associated with the photometer</li> <li>- Bad/incorrect Span Gas concentration</li> <li>- Contamination of the Zero Air supply.</li> <li>- Malfunction of the O<sub>3</sub> generator.</li> <li>- Internal A/D converter problem</li> </ul> |

### 8.3. USING THE INTERNAL ELECTRONIC STATUS LEDs

Several LEDs are located inside the instrument to assist in determining if the calibrators CPU, I<sup>2</sup>C bus and Power distribution board are functioning properly.

#### 8.3.1. CPU STATUS INDICATOR

DS5, a red LED, that is located on upper portion of the motherboard, just to the right of the CPU board, flashes when the CPU is running the main program loop. After power-up, approximately 30 – 60 seconds, DS5 should flash on and off. If characters are written to the Input and Control Panel display but DS5 does not flash then the program files have become corrupted, contact Technical Support because it may be possible to recover operation of the calibrator. If after 30 – 60 seconds neither DS5 is flashing and no characters have been written to the Input and Control Panel display then the CPU is bad and must be replaced.

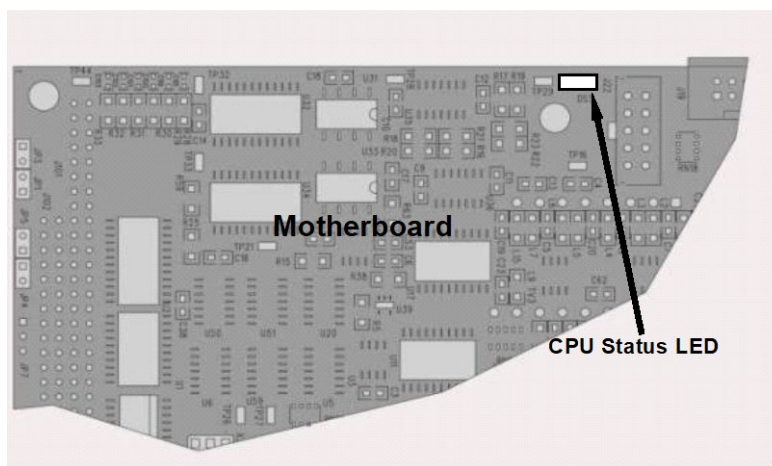

Figure 8-1: CPU Status Indicator

#### 8.3.2. POWER DISTRIBUTION BOARD STATUS LEDs

There are sixteen status LEDs on the Power distribution board. Not all are used on this model.



### 8.3.2.1. I<sup>2</sup>C Bus Watchdog Status LEDs

The most important is D1 (see Figure 8-2), which indicates the health of the I<sup>2</sup>C bus.

**Table 8-4: Power Distribution Board Watchdog LED Failure Indications**

| LED         | Function                                          | Fault Status                              | Indicated Failure(s)                                                                                                                                                                          |
|-------------|---------------------------------------------------|-------------------------------------------|-----------------------------------------------------------------------------------------------------------------------------------------------------------------------------------------------|
| D1<br>(Red) | I <sup>2</sup> C bus Health<br>(Watchdog Circuit) | Continuously ON<br>or<br>Continuously OFF | Failed/Halted CPU<br>Faulty Motherboard or Power distribution board<br>Faulty Connectors/Wiring between Motherboard or<br>Power distribution board<br>Failed/Faulty +5 VDC Power Supply (PS1) |

If D1 is blinking, then the other LEDs can be used in conjunction with the Utilities>Diagnostics>Analog Inputs menu to identify hardware failures of the relays and switches on the Relay.

### 8.3.2.2. Troubleshooting with Power Distribution Board Status LEDs

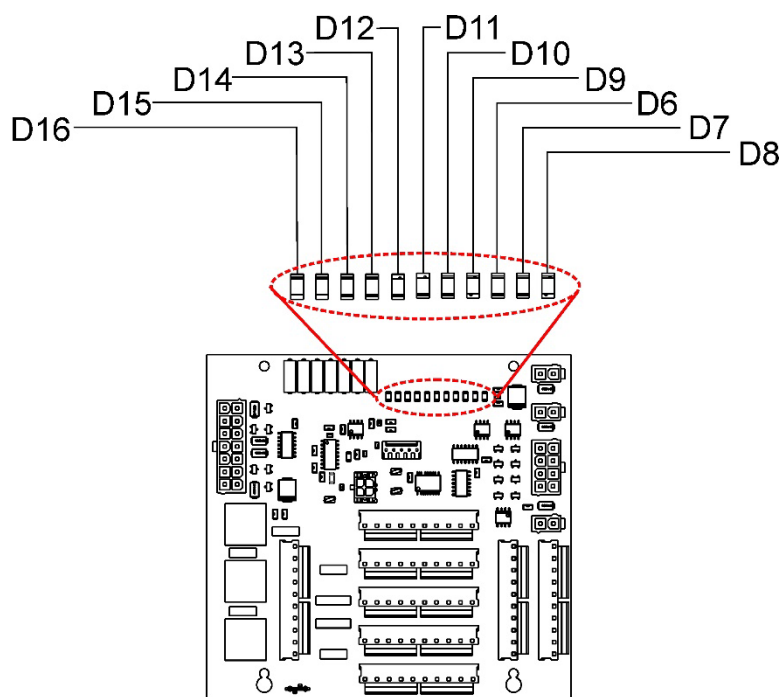

**Figure 8-2: Power Distribution Board Status LEDs Used for Troubleshooting**

**Table 8-5: Power Distribution Board Status LED Failure Indications**

| <b>LED</b>   | <b>INDICATES</b>                         | <b>ACTIVATED BY DIGITAL OUTPUT</b> | <b>DIAGNOSTIC TECHNIQUE</b>                                                                                                                                                                                                                                                     |
|--------------|------------------------------------------|------------------------------------|---------------------------------------------------------------------------------------------------------------------------------------------------------------------------------------------------------------------------------------------------------------------------------|
| D7<br>Green  | Photometer Meas/Ref Valve                | <b>Photo Ref Valve</b>             | Valve should audibly change states. If not: <ul style="list-style-type: none"> <li>Failed Valve</li> <li>Failed Relay Drive IC on Power distribution board</li> </ul>                                                                                                           |
| D8<br>Green  | External Zero Air Shutoff Valve (option) | <b>Zero Air Shutoff Valve</b>      | <ul style="list-style-type: none"> <li>Failed Power distribution board</li> <li>Faulty +12 VDC Supply</li> <li>Faulty Connectors/Wiring</li> </ul>                                                                                                                              |
| D9<br>Green  | O <sub>3</sub> Photometer Pump           | <b>O3_PUMP_ON</b>                  | Pump should start /stop. If not: <ul style="list-style-type: none"> <li>Failed pump</li> <li>Failed Drive IC on Power distribution board</li> <li>Failed Power distribution board</li> <li>Faulty +12 VDC Supply</li> <li>Faulty Connectors/Wiring</li> </ul>                   |
| D10<br>Green | O <sub>3</sub> Divert Valve              | <b>O3_DIVERT_VALVE</b>             | Valve should audibly change states. If not: <ul style="list-style-type: none"> <li>Failed Valve</li> <li>Failed Relay Drive IC on Power distribution board</li> </ul>                                                                                                           |
| D11<br>Green | O <sub>3</sub> Generator Valve           | <b>O3_GEN_VALVE</b>                | <ul style="list-style-type: none"> <li>Failed Power distribution board</li> <li>Faulty +12 VDC Supply</li> <li>Faulty Connectors/Wiring</li> </ul>                                                                                                                              |
| D12<br>Green | Internal Zero Air Pump (option)          | <b>Zero Air Pump</b>               | Pump should start /stop. If not: <ul style="list-style-type: none"> <li>Failed pump</li> <li>Failed Power distribution board</li> <li>Faulty DC Power Supply</li> <li>Faulty Connectors/Wiring</li> </ul>                                                                       |
| D13<br>Green | Internal Zero Air Pump Valve             | <b>Zero Air Pump Valve</b>         | Valve should audibly change states. If not: <ul style="list-style-type: none"> <li>Failed Valve</li> <li>Failed Relay Drive IC on Power distribution board</li> <li>Failed Power distribution board</li> <li>Faulty +12 VDC Supply</li> <li>Faulty Connectors/Wiring</li> </ul> |
| D15<br>Green | Photometer Heater                        | <b>Photo Lamp Heater</b>           | Voltage displayed should change. If not: <ul style="list-style-type: none"> <li>Failed Heater</li> </ul>                                                                                                                                                                        |
| D16<br>Green | O <sub>3</sub> Generator Heater          | <b>O3 Gen Lamp Heater</b>          | <ul style="list-style-type: none"> <li>Faulty Temperature Sensor</li> <li>Faulty Connectors/Wiring</li> </ul>                                                                                                                                                                   |

D1 = Watchdog; D2 thru D6, D14 = Spares

## 8.4. SUBSYSTEM CHECKOUT

The preceding sections of this manual discussed a variety of methods for identifying possible sources of failures or performance problems within the T753U calibrator. In most cases, this includes a list of possible components or subsystems that might be the source of the problem. This section describes how to check individual components or subsystems to determine if which is actually the cause of the problem being investigated.

### 8.4.1. VERIFY SUBSYSTEM CALIBRATION

A good first step when troubleshooting the operation of the T753U calibrator is to verify that its major subsystems are properly calibrated. These are:

- Test Channel Digital to Analog conversion (see Section 8.4.8.1).
- Gas pressure calibration (see Section 6.3).
- Photometer calibration (see Section 6.1).
- O<sub>3</sub> generator calibration (see Section 6.2).

### 8.4.2. AC MAIN POWER

The T753U calibrator's electronic systems will operate with any of the specified power regimes. As long as system is connected to 100-120 VAC or 220-240 VAC at either 50 or 60 Hz it will turn on and after about 30 seconds show a Input and Control Panel display.

- Internally, the status LEDs located on the Power distribution board, motherboard and CPU should turn on as soon as the power is supplied.
- If they do not, check the circuit breaker built into the ON/OFF switch on the instruments Input and Control Panel

#### WARNING – Electrical Shock Hazard



**Should the AC power circuit breaker trip, investigate and correct the condition causing this situation before powering on the calibrator again.**

### 8.4.3. DC POWER SUPPLY

If you have determined that the calibrator's AC main power is working, but the unit is still not operating properly, there may be a problem with one of the instrument's switching power supplies. The supplies can have two faults, namely no DC output, and noisy output.

To assist tracing DC Power Supply problems, the wiring used to connect the various printed circuit assemblies and DC Powered components and the associated test points on the power distribution board follow a standard color-coding scheme as defined in the following table.

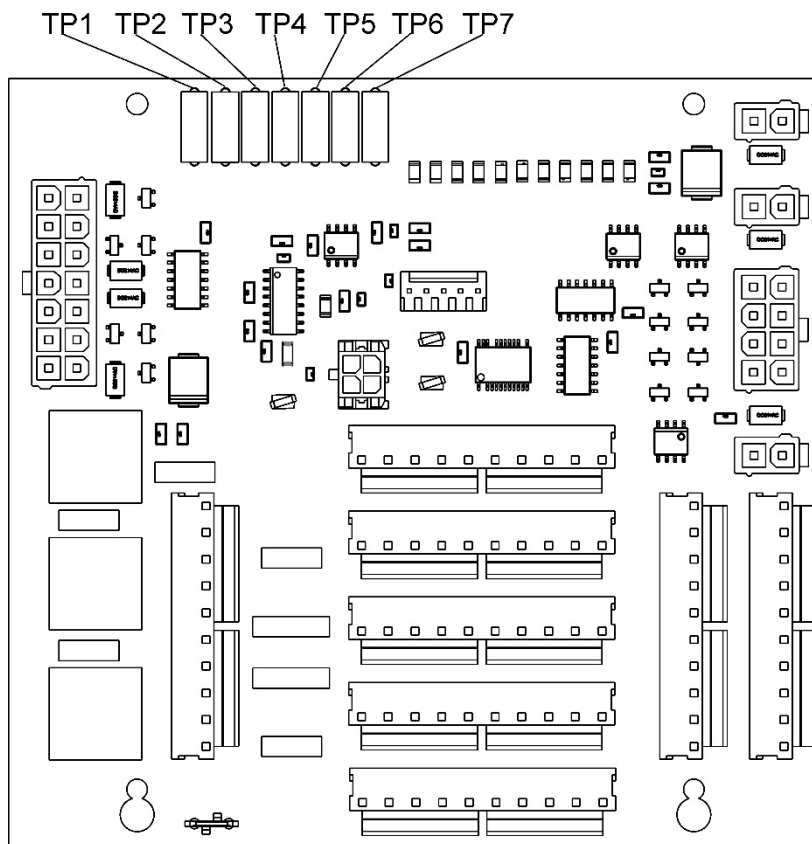

Figure 8-3: Location of DC Power Test Points on Power distribution board

Table 8-6: DC Power Test Point and Wiring Color Codes

| NAME | TEST POINT# | TP AND WIRE COLOR |
|------|-------------|-------------------|
| Dgnd | 1           | Black             |
| +5V  | 2           | Red               |
| Agnd | 3           | Green             |
| +15V | 4           | Blue              |
| -15V | 5           | Yellow            |
| +12R | 6           | Purple            |
| +12V | 7           | Orange            |

A voltmeter should be used to verify that the DC voltages are correct per the values in the table below, and an oscilloscope, in AC mode, with band limiting turned on, can be used to evaluate if the supplies are producing excessive noise (> 100 mV p-p).

**Table 8-7: DC Power Supply Acceptable Levels**

| POWER SUPPLY ASSY | VOLTAGE | CHECK POWER DISTRIBUTION BOARD TEST POINTS |   |               |     | MIN V | MAX V |
|-------------------|---------|--------------------------------------------|---|---------------|-----|-------|-------|
|                   |         | FROM TEST POINT                            |   | TO TEST POINT |     |       |       |
|                   |         | NAME                                       | # | NAME          | #   |       |       |
| PS1               | +5      | Dgnd                                       | 1 | +5            | 2   | 4.8   | 5.25  |
| PS1               | +15     | Agnd                                       | 3 | +15           | 4   | 13.5  | 16V   |
| PS1               | -15     | Agnd                                       | 3 | -15V          | 5   | -14V  | -16V  |
| PS1               | Agnd    | Agnd                                       | 3 | Dgnd          | 1   | -0.05 | 0.05  |
| PS1               | Chassis | Dgnd                                       | 1 | Chassis       | N/A | -0.05 | 0.05  |
| PS2               | +12     | +12V Ret                                   | 6 | +12V          | 7   | 11.75 | 12.5  |
| PS2               | Dgnd    | +12V Ret                                   | 6 | Dgnd          | 1   | -0.05 | 0.05  |

#### 8.4.4. I<sup>2</sup>C Bus

Operation of the I<sup>2</sup>C bus can be verified by observing the behavior of D1 on the power distribution board & D2 on the Valve Driver PCA. Assuming that the DC power supplies are operating properly, the I<sup>2</sup>C bus is operating properly if D1 on the power distribution board and D2 of the Valve Driver PCA are flashing

There is a problem with the I<sup>2</sup>C bus if both D1 on the power distribution board and D2 of the Valve Driver PCA are ON/OFF constantly.

#### 8.4.5. TOUCHSCREEN INTERFACE

Verify the functioning of the touch screen by observing the display when pressing a touch-screen control button. Assuming that there are no wiring problems and that the DC power supplies are operating properly, but pressing a control button on the touch screen does not change the display, any of the following may be the problem:

- The touch-screen controller may be malfunctioning.
- The internal USB bus may be malfunctioning.

You can verify this failure by logging on to the instrument using NumaView™ Remote software or a terminal program. If the instrument responds to remote commands and the display changes accordingly, the touch-screen interface may be faulty.

### 8.4.6. POWER DISTRIBUTION BOARD

The Power distribution board can be most easily checked by observing the condition of the status LEDs located along its upper edge (see Section 8.3.2 and Figure 8-2), and observing the Utilities>Diagnostics>Analog Inputs menu (see Section 8.1.3) while toggling each LED **ON** or **OFF**.

If D1 on the Power distribution board is flashing and the status indicator for the output in question (Pump power, Heater power, Valve Drive, etc.) toggles properly using the Analog Inputs function, then the associated control device on the Power distribution board is bad. Several of the control devices are in sockets and can be easily replaced. The table below lists the control device associated with a particular function.

**Table 8-8: Power Distribution Board Control Devices**

| FUNCTION                  | CONTROL DEVICE | IN SOCKET |
|---------------------------|----------------|-----------|
| UV Lamp Heater            | Q2             | No        |
| O <sub>3</sub> Gen Heater | Q3             | No        |
| All Valves                | U5             | Yes       |
| DC Photometer Pump        | U1             | No        |

### 8.4.7. PHOTOMETER O<sub>3</sub> GENERATOR PRESSURE /FLOW SENSOR ASSEMBLY

The pressure/flow sensor PCA, located on the inside rear panel, can be checked with a Voltmeter. The following procedure assumes that the wiring is intact and that the motherboard as well as the power supplies are operating properly:

#### BASIC PCA OPERATION:

- Measure the voltage across C1; it should be 10 VDC  $\pm$  0.25 VDC. If not then the board is bad.
- Measure the voltage between TP2 and TP1 C1; it should be 10 VDC  $\pm$  0.25 VDC. If not then the board is bad.
- Measure the voltage across C2; it should be 5 VDC  $\pm$  0.25 VDC. If not then the board is bad.

**PHOTOMETER PRESSURE SENSOR (ABSOLUTE PRESSURE):**

- Measure the pressure on the inlet side of S1 with an external pressure meter.
- Measure the voltage across TP4 and TP1.
  - The expected value for this signal should be:

$$\text{Expected mVDC} = \left( \frac{\text{Pressure}}{30.0_{\text{Hg-in-A}}} \times 4660_{\text{mVDC}} \right) + 250_{\text{mVDC}} \quad \pm 10\%_{\text{rdg}}$$

EXAMPLE: If the measured pressure is 20 Hg-in-A, the expected voltage level between TP4 and TP1 would be between 2870 mVDC and 3510 mVDC.

EXAMPLE: If the measured pressure is 25 Hg-in-A, the expected voltage level between TP4 and TP1 would be between 3533 mVDC and 4318 mVDC.

- If this voltage is out of range, then either pressure transducer S1 is bad, the board is bad or there is a pneumatic failure preventing the pressure transducer from sensing the absorption cell pressure properly.

**O<sub>3</sub> GENERATOR PRESSURE SENSOR (GAUGE PRESSURE):**

- Measure the pressure on the inlet side of S2 with an external pressure meter.
- Measure the voltage across TP5 and TP1.
  - The expected value for this signal should be:

$$\text{Expected mVDC} = \left( \frac{\text{Pressure}}{100_{\text{psig}}} \times 4250_{\text{mVDC}} \right) + 250_{\text{mVDC}} \quad \pm 10\%_{\text{rdg}}$$

EXAMPLE: If the measured pressure is 25 psig, the expected voltage level between TP4 and TP1 would be between 1182 mVDC and 1444 mVDC.

EXAMPLE: If the measured pressure is 30 psig, the expected voltage level between TP4 and TP1 would be between 1373 mVDC and 1677 mVDC.

- If this voltage is out of range, then either pressure transducer S1 is bad, the board is bad or there is a pneumatic failure preventing the pressure transducer from sensing the absorption cell pressure properly.

**PHOTOMETER FLOW SENSOR:**

- Measure the voltage across TP3 and TP1.
  - With proper flow (800 cc<sup>3</sup>/min through the photometer), this should be approximately 4.5V (this voltage will vary with altitude).
  - With flow stopped (photometer inlet disconnected or pump turned OFF) the voltage should be approximately 1V.
  - If the voltage is incorrect, the flow sensor S3 is bad, the board is bad or there is a leak upstream of the sensor.

## 8.4.8. MOTHERBOARD

### 8.4.8.1. A/D Functions

The simplest method to check the operation of the A-to-D converter on the motherboard is to use the Analog Inputs page in the Utilities>Diagnostics menu to check the two A/D reference voltages and input signals that can be easily measured with a voltmeter.

- Use the Analog Inputs function to view the value of **Ref 4096mV** and **Ref Ground**. If both are within 3 mV of nominal (4096 and 0), and are stable,  $\pm 0.5$  mV then the basic A/D is functioning properly. If not then the motherboard is bad.
- Choose an Analog Inputs function such as **O3 Gen Drive** or **O3 Gen Lamp Temp**.
- **Compare** these voltages at their origin (see the interconnect drawing in Appendix D) with the voltage displayed through the Utilities>Diagnostics>Analog Inputs menu.
- **If** the wiring is intact but there is a large difference between the measured and displayed voltage ( $\pm 10$  mV) then the motherboard is bad.

### 8.4.8.2. Test Channel / Analog Outputs Voltage

To verify that the analog output is working properly, connect a voltmeter to the analog output perform an analog output step test as follows:

1. Navigate to the Utilities>Diagnostics>Analog Outputs page

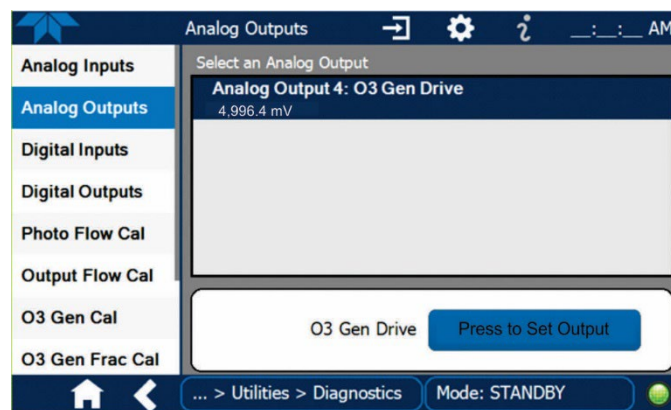

Figure 8-4: Analog Outputs Page

2. Press the Press to Set Output button to set the desired percent of the signal output in the numeric keypad that pops up, and press Enter.
3. Compare the value displayed in the Analog Output field to the voltmeter.

For each percentage set, the output should be within 1% of the nominal value. Use the table below as an example. Ensure to take into account any offset that may have been programmed into the analog output channel.



**Table 8-9: Analog Output Test Function - Nominal Values Voltage Outputs**

| SIGNAL<br>% | FULL SCALE OUTPUT OF VOLTAGE RANGE |     |    |     |
|-------------|------------------------------------|-----|----|-----|
|             | 100MV                              | 1V  | 5V | 10V |
|             | NOMINAL OUTPUT VOLTAGE             |     |    |     |
| 0           | 0                                  | 0   | 0  | 0   |
| 20          | 20 mV                              | 0.2 | 1  | 2   |
| 40          | 40 mV                              | 0.4 | 2  | 4   |
| 60          | 60 mV                              | 0.6 | 3  | 6   |
| 80          | 80 mV                              | 0.8 | 4  | 8   |
| 100         | 100 mV                             | 1.0 | 5  | 10  |

If one or more of the readings fails to be within range, it is likely that there has been a failure of the either or both of the DACs and their associated circuitry on the motherboard.

### 8.4.8.3. Status Outputs (Digital Output Pins 1 – 8)

To test the status output electronics:

1. Connect a jumper between the “D” pin and the “▽” pin on the status output connector.
2. Connect a 1000 ohm resistor between the “+” pin and the pin for the status output that is being tested.
3. Connect a voltmeter between the “▽” pin and the pin of the output being tested (see table below).
4. Under the Utilities>Diagnostics menu scroll to the output in question.
5. Alternately turn on and off the output noting the voltage on the voltmeter.
  - It should vary between 0 volts for ON and 5 volts for OFF.

### 8.4.8.4. Digital Control Inputs

**Table 8-10: T753U Digital Control Input Pin Assignments and Corresponding Functions**

| INPUT | CORRESPONDING I/O SIGNAL |
|-------|--------------------------|
| 1     | CONTROL_IN_1             |
| 2     | CONTROL_IN_2             |
| 3     | CONTROL_IN_3             |
| 4     | CONTROL_IN_4             |
| 5     | CONTROL_IN_5             |
| 6     | CONTROL_IN_6             |
| 7     | CONTROL_IN_7             |
| 8     | CONTROL_IN_8             |
| 9     | CONTROL_IN_9             |
| 10    | CONTROL_IN_10            |
| 11    | CONTROL_IN_11            |
| 12    | CONTROL_IN_12            |

The control input bits can be tested by applying a trigger voltage to an input and watching changes in the status of the associated function under the Utilities>Diagnostics menu:

EXAMPLE: to test the “A” control input:

1. Under the Utilities>Diagnostics menu scroll to the input for **CONTROL\_IN\_1**.
2. Connect a jumper from the “+” pin on the appropriate connector to the “U” on the same connector.
3. Connect a second jumper from the “▽” pin on the connector to the “A” pin.

The status of **CONTROL\_IN\_1** should change to read “ON”.

#### 8.4.8.5. Control Outputs (Digital Output Pins 1 – 12)

Table 8-11: Control Outputs Pin Assignments and Corresponding Functions Check

| PIN (RIGHT TO LEFT) | STATUS         |
|---------------------|----------------|
| 1                   | CONTROL_OUT_1  |
| 2                   | CONTROL_OUT_2  |
| 3                   | CONTROL_OUT_3  |
| 4                   | CONTROL_OUT_4  |
| 5                   | CONTROL_OUT_5  |
| 6                   | CONTROL_OUT_6  |
| 7                   | CONTROL_OUT_7  |
| 8                   | CONTROL_OUT_8  |
| 9                   | CONTROL_OUT_9  |
| 10                  | CONTROL_OUT_10 |
| 11                  | CONTROL_OUT_11 |
| 12                  | CONTROL_OUT_12 |

To test the Control Output electronics:

1. Connect a jumper between the “E” pin and the “▽” pin on the status output connector.
2. Connect a 1000 ohm resistor between the “+” pin and the pin for the status output that is being tested.
3. Connect a voltmeter between the “▽” pin and the pin of the output being tested (see Table 8-11).
4. Under the Utilities>Diagnostics>Digital Outputs, scroll to the output in question.
5. Alternately turn on and off the output noting the voltage on the voltmeter.
  - It should vary between 0 volts for ON and 5 volts for OFF.

### 8.4.9. CPU

There are two major types of CPU board failures, a complete failure and a failure associated with the Disk On Module (DOM). If either of these failures occurs, contact the factory.

For complete failures, assuming that the power supplies are operating properly and the wiring is intact, the CPU is faulty if on power-on, the watchdog LED on the motherboard is not flashing.

In some rare circumstances, this failure may be caused by a bad IC on the motherboard, specifically U57, the large, 44 pin device on the lower right hand side of the board. If this is true, removing U57 from its socket will allow the instrument to start up but the measurements will be invalid.

If the instrument stops during initialization (triggering an Alert), it is likely that the DOM, the firmware or the configuration and data files have been corrupted.

### 8.4.10. RS-232 COMMUNICATIONS

#### 8.4.10.1. General RS-232 Troubleshooting

Teledyne API calibrators use the RS-232 communications protocol to allow the instrument to be connected to a variety of computer-based equipment. RS-232 has been used for many years and as equipment has become more advanced, connections between various types of hardware have become increasingly difficult. Generally, every manufacturer observes the signal and timing requirements of the protocol very carefully.

Problems with RS-232 connections usually center around four general areas:

- Incorrect cabling and connectors.
- The BAUD rate and protocol are incorrectly configured.
- Incorrect setting of the DTE – DCE Switch.
- Verify that cable (03596) that connects the serial COM ports of the CPU to J12 of the motherboard is properly seated

### 8.4.11. TEMPERATURE PROBLEMS

Individual control loops are used to maintain the set point of the UV lamp and ozone generator. If any of these temperatures are out of range or are poorly controlled, the T753U will perform poorly.

#### 8.4.11.1. Box / Chassis Temperature

The box temperature sensor is mounted to the motherboard and cannot be disconnected to check its resistance. Rather check the **BOX TEMP** signal in the Dashboard. This parameter will vary with ambient temperature, but at ~30°C (6-7° above room temperature) the signal should be ~1450 mV.

#### 8.4.11.2. Photometer Sample Chamber Temperature

The temperature of the gas in the photometer sample chamber should read approximately 5.0°C higher than the box temperature.

### 8.4.11.3. UV Lamp Temperature

There are three possible causes for the UV Lamp temperature to have failed.

- The UV Lamp heater has failed. Check the resistance between pins 5 and 6 on the six-pin connector adjacent to the UV Lamp on the Optical Bench.
  - It should be approximately 30 Ohms.
- Assuming that the I<sup>2</sup>C bus is working and that there is no other failure with the Power distribution board, the FET Driver on the Power distribution board may have failed.
  - Using the **PHOTO\_LAMP\_HEATER** parameter in the Utilities>Diagnostics menu, as described above, turn on and off the UV Lamp Heater (D15 on the power distribution board should illuminate as the heater is turned on).
  - Check the DC voltage present between pin 1 and 2 on J13 of the Power distribution board.
  - If the FET Driver has failed, there will be no change in the voltage across pins 1 and 2.
- If the FET Driver Q2 checks out OK, the thermistor temperature sensor in the lamp assembly may have failed.
  - Unplug the connector to the UV Lamp Heater/Thermistor PCB, and measure the resistance of the thermistor between pins 5 and 6 of the 6-pin connector.
  - The resistance near the 58°C set point is ~8.1k ohms.

### 8.4.11.4. Ozone Generator Temperature

There are three possible causes for the Ozone Generator temperature to have failed.

- The O<sub>3</sub> generator heater has failed. Check the resistance between pins 5 and 6 on the 6-pin connector adjacent to the UV Lamp on the O<sub>3</sub> Generator. It should be approximately 5 Ohms.
- Assuming that the I<sup>2</sup>C bus is working and that there is no other failure with the Power distribution board, the FET Driver on the Power distribution board may have failed. Using the **O3\_GEN\_HEATER** parameter in the Utilities>Diagnostics menu, as described above, turn on and off the UV Lamp Heater. Check the DC voltage present between pin 1 and 2 on J14 of the Power distribution board.

If the FET Driver has failed, there should be no change in the voltage across pins 1 and 2.

- If the FET Driver checks out OK, the thermistor temperature sensor in the lamp assembly may have failed. Unplug the connector to the Ozone Generator Heater/Thermistor PCB, and measure the resistance of the thermistor between pins 5 and 6 of the 6-pin connector.

## 8.5. TROUBLESHOOTING THE O<sub>3</sub> PHOTOMETER

### 8.5.1. DYNAMIC PROBLEMS WITH THE O<sub>3</sub> PHOTOMETER

Dynamic problems only manifest when the photometer is measuring O<sub>3</sub> concentration gas mixtures. These can be the most difficult and time-consuming to isolate and resolve.

Since many photometer behaviors that appear to be a dynamic in nature are often a symptom of a seemingly unrelated static problems, it is recommended that dynamic problems not be addressed until all static problems, warning conditions and subsystems have been checked and any problems found are resolved.

Once this has been accomplished, the following most common dynamic problems should be checked.

#### 8.5.1.1. Noisy or Unstable O<sub>3</sub> Readings at Zero

- Check for leaks in the pneumatic system as described in Section 7.2
- Confirm that the Zero gas is free of Ozone.
- Confirm that the Source Lamp is fully inserted and that the lamp hold-down thumb- screw is tight.
- Check for a dirty Absorption Cell and/or pneumatic lines. Clean as necessary as described in Section 7.2
- Disconnect the exhaust line from the optical bench (the pneumatic line at the lamp end of the bench) and plug the port in the bench. If readings remain noisy, the problem is in one of the electronic sections of the instrument. If readings become quiet, the problem is in the instrument's pneumatics.

#### 8.5.1.2. Noisy, Unstable, or Non-Linear Span O<sub>3</sub> Readings

- Check for leaks in the pneumatic systems as described in Section 7.2.
- Check for proper operation of the meas/ref switching valve as described in Section 8.5.2.
- Check for dirty absorption cell and clean or replace as necessary as described in Section 7.2
- Check for operation of the A/D circuitry on the motherboard. See Section 8.4.8.1.
- Confirm the Sample Temperature, Sample Pressure and Sample Flow readings are correct. Check and adjust as required.

#### 8.5.1.3. Slow Response to Changes in Concentration

- Check for dirty absorption cell and clean or replace as necessary as described in Section 7.2
- Check for pneumatic leaks as described in Section 7.2
- Check for improper materials (debris, contaminants) in the inlet manifold.
- The photometer needs 800 cc<sup>3</sup>/min of gas flow. Make sure that this is accounted for when calculating total required output flow for the calibrator (see Section 4.4).

#### 8.5.1.4. The Analog Output Signal Level Does Not Agree With Input / Control Panel Readings

- Confirm that the recorder offset (see Section 3.3.9.2) is set to zero.
- Perform an Analog Output calibration (see Section 3.3.9.3).

#### 8.5.1.5. Cannot Zero

- Check for leaks in the pneumatic system as described in Section 7.2.
- Confirm that the Zero gas is free of Ozone.
- The photometer needs 800 cc<sup>3</sup>/min of gas flow. Make sure that this is accounted for when calculating total required output flow for the calibrator (see Section 4.4).

#### 8.5.1.6. Cannot Span

- Check for leaks in the pneumatic systems as described in Section 7.2.
- Check for proper operation of the meas/ref switching valve as described in Section 8.5.2.
- Check for dirty absorption cell and clean or replace as necessary as described in Section 7.2
- Check for operation of the A/D circuitry on the motherboard. See Section 8.4.8.1.
- Confirm the Sample Temperature, Sample Pressure and Sample Flow readings are correct. Check and adjust as required.
- The photometer needs 800 cc<sup>3</sup>/min of gas flow. Make sure that this is accounted for when calculating total required output flow for the calibrator (see Section 4.4).

### 8.5.2. CHECKING MEASURE / REFERENCE VALVE

To check the function of the photometer's measure / reference valve:

1. Set the Dashboard display to show the photometer reference parameter, O3 Ref.
2. Ensure the calibrator is set up as required to produce ozone.
3. In the Generate menu press AUTO and set the gas to O3 and the concentration to 0.0.
4. Press the Generate button.
5. While generating, navigate to the Dashboard and record the O3 Ref value.
6. Return to the Generate menu, press the Standby button and change the concentration to 400 PPB.
7. Press the Generate button.
8. Return to the Dashboard, allow time to stabilize, and observe the O3 Ref value.

If the O3 Ref value has decreased by more than 2.0 mV from the value noted in Step 5 above, then there is a cross-port leak in the measure/reference valve, and it needs to be replaced.

## 8.6. TROUBLESHOOTING THE O<sub>3</sub> GENERATOR



### WARNING – ELECTRICAL SHOCK HAZARD

Hazardous voltage present - use caution.

1. Make sure the calibrator is idling in **STANDBY** mode.
2. Unplug the cable connector at P1 on the Lamp Power Supply and confirm that +15VDC is present between Pins 1 and 2 on the cable connector.
  - If this voltage is incorrect, check the DC test points on the power distribution board as described in Section 8.4.3.
3. Remove the cover of the photometer and check for the presence of the following voltages on the UV lamp power supply PCA:
  - +800 mVDC  $\pm$  10 mVDC between TP1 and TP4 (grnd)
    - If this voltage is incorrect, either the UV lamp power supply PCA is faulty or the I<sup>2</sup>C bus is not communicating with the UV lamp power supply PCA.
  - +5VDC between TP3 and TP4 (grnd)
    - If this voltages is less than 4.8 or greater than 5.25, either the 5 VDC power supply or the UV lamp power supply PCA are faulty.

If the above voltages check out, it is more likely that a problem is due to the UV Lamp than due to the Lamp Power Supply. Replace the UV Lamp and if the problem persists, replace the Lamp Power Supply.

## 8.7. REPAIR PROCEDURES

### 8.7.1. REPAIRING SAMPLE FLOW CONTROL ASSEMBLY

The critical flow orifice is housed in the flow control assembly (Teledyne API part number: 001760400) located on the top of the optical bench. A sintered filter protects the jewel orifice so it is unusual for the orifice to need replacing, but if it does, or the filter needs replacement please use the following procedure (see the Spare Parts list in Appendix B for part numbers and kits):

1. Turn off power to the calibrator.
2. Locate the assembly to be repaired, see Figure 9-1 (T753U).
3. Disconnect the pneumatic connection from the flow assembly.
4. Remove the fitting and the components as shown in the exploded view in Figure 8-5.
5. Replace the o-rings (p/n OR000001) and the sintered filter (p/n FL000001).
6. If replacing the critical flow orifice itself (P/N 000941000), make sure that the side with the colored window (usually red) is facing downstream to the gas flow.
7. Apply new Teflon<sup>®</sup> tape to the male connector threads.
8. Reassemble in reverse order.

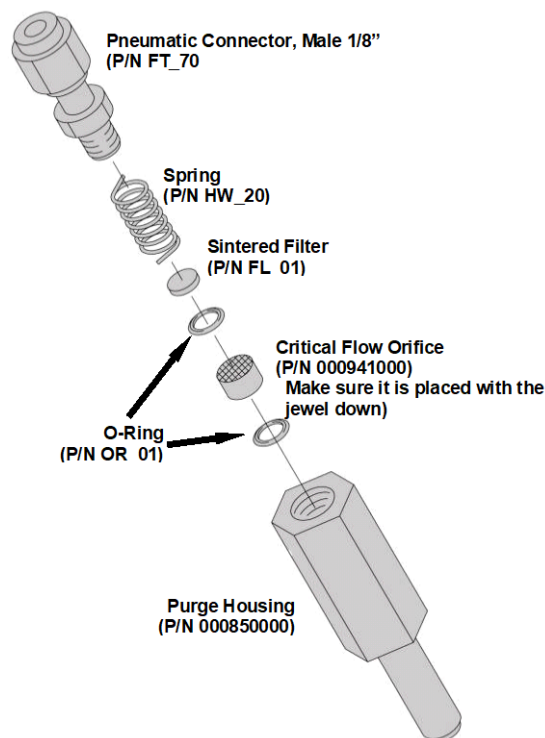

Figure 8-5: Critical Flow Restrictor Assembly Disassembly

### 8.7.2. DISK-ON-MODULE REPLACEMENT PROCEDURE

Replacing the Disk-on-Module (DOM) will cause loss of all DAS data; it also may cause loss of some instrument configuration parameters unless the replacement DOM carries the exact same firmware version. Whenever changing the version of installed software, the memory must be reset. Failure to ensure that memory is reset can cause the instrument to malfunction, and invalidate measurements.

After the memory is reset, the A/D converter must be re-calibrated, and all information collected in Step 1 below must be re-entered before the instrument will function correctly. Also, zero and span calibration should be performed.

1. Document all instrument parameters that may have been changed, such as range, auto-cal, analog output, serial port and other settings before replacing the DOM. (You will need this information to re-enter at the end of this procedure).
2. Turn off power to the instrument, fold down the communications and output panel by loosening the mounting screws.
3. When looking at the electronic circuits from the back of the instrument, locate the Disk-on-Module in the right most socket of the CPU board.  
The DOM should carry a label with firmware revision, date and initials of the programmer.
4. Remove the nylon fastener that mounts the DOM over the CPU board, and lift the DOM off the CPU. Do not bend the connector pins.



5. Install the new Disk-on-Module, making sure the notch at the end of the chip matches the notch in the socket.

It may be necessary to straighten the pins somewhat to fit them into the socket. Press the DOM all the way in and reinsert the offset clip.

6. Close the communications and output panel and turn on power to the machine.
7. If the replacement DOM carries a firmware revision, re-enter all of the setup information.
8. Recalibrate A/D converter, and conduct a Zero and Span calibration as well.

## 8.8. TECHNICAL ASSISTANCE

If this manual and its trouble-shooting / service sections do not solve your problems, technical assistance may be obtained from

**TELEDYNE-API, TECHNICAL SUPPORT**  
**9970 CARROLL CANYON ROAD**  
**SAN DIEGO, CALIFORNIA 92131-1106**  
**USA**

**Toll-free Phone: 800-324-5190**  
**Phone: +1 858-657-9800**  
**Fax: +1 858-657-9816**  
**Email: [sda\\_techsupport@teledyne.com](mailto:sda_techsupport@teledyne.com)**  
**Website: <http://www.teledyne-api.com/>**

Before you contact Technical Support, fill out the problem report available online for electronic submission at <http://www.teledyne-api.com/forms/>.

This page intentionally left blank.

## 9. PRINCIPLES OF OPERATION

This section provides information about the scientific principles based on which this instrument operates.

### 9.1. PNEUMATIC OPERATION

The T753U calibrator's pneumatic system is comprised of an internal ozone photometer with a closed loop feedback system to control the ozone concentration.

#### 9.1.1. GAS FLOW CONTROL

Gas flow rates are set by various flow control assemblies in the gas stream(s), locations indicated in Figure 9-1.

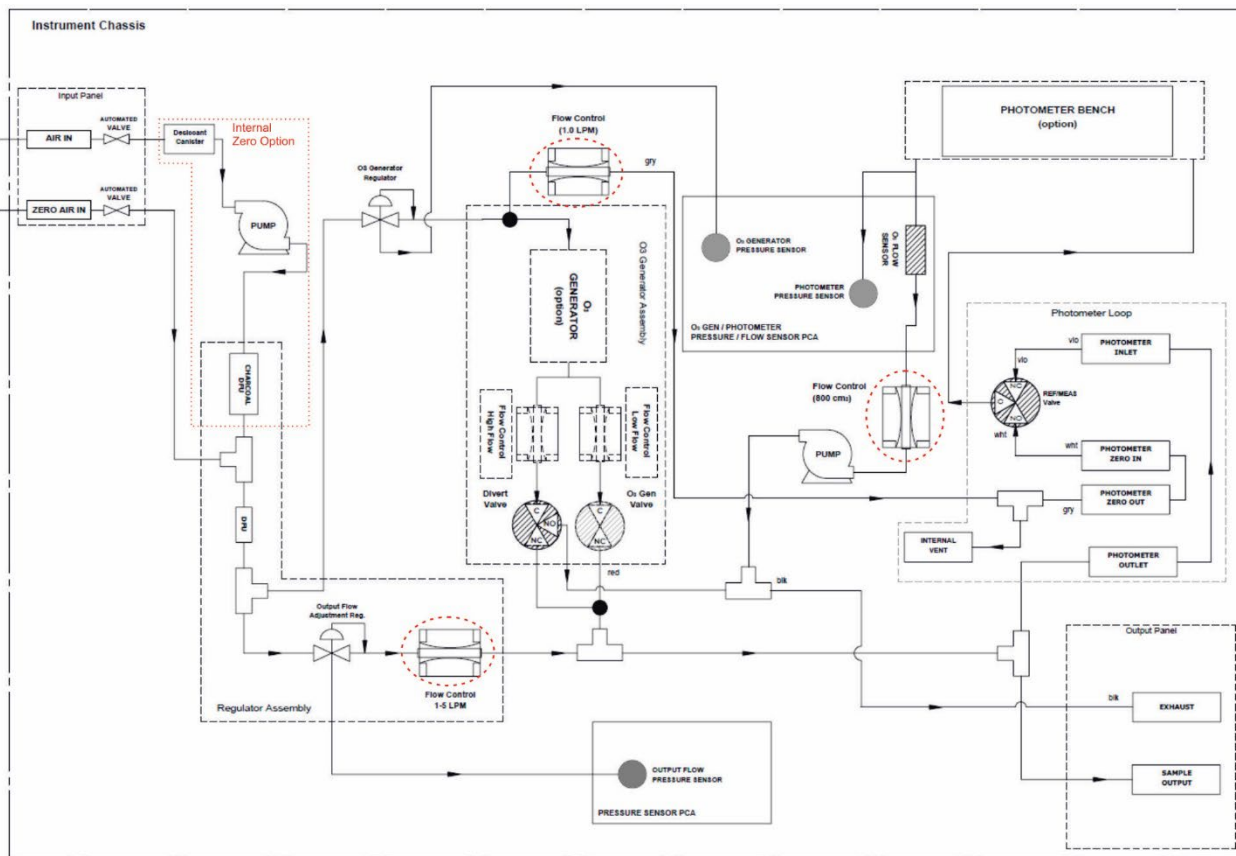

Figure 9-1: Location of Gas Flow Control Assemblies

#### 9.1.1.1. Photometer Critical Flow Orifice

Critical flow orifices regulate stable gas flow rates. They operate without moving parts by taking advantage of the laws of fluid dynamics: restrict the flow of gas through the orifice to create a pressure differential. This pressure differential combined with the action of the calibrator's pump draws the gas through the orifice.

As the pressure on the downstream side of the orifice (the pump side) continues to drop, the speed that the gas flows through the orifice continues to rise. Once the ratio of upstream pressure to downstream pressure is greater than 2:1, the velocity of the gas through the

orifice reaches the speed of sound. As long as that ratio stays at least 2:1 the gas flow rate is unaffected by any fluctuations, surges, or changes in downstream pressure because such variations only travel at the speed of sound themselves and are therefore cancelled out by the sonic shockwave at the downstream exit of the critical flow orifice.

The actual flow rate of gas through the orifice (volume of gas per unit of time), depends on the size and shape of the aperture in the orifice. The larger the hole, the more gas molecules, moving at the speed of sound, pass through the orifice.

### 9.1.2. INTERNAL GAS PRESSURE SENSORS

There are three pressure sensors in the T753U.

**Table 9-1: Pressure Sensors and their Descriptions**

| SENSOR                   | FUNCTION                                                             | DASHBOARD TAG      |
|--------------------------|----------------------------------------------------------------------|--------------------|
| Ozone Generator Pressure | measures the gas pressure of the zero air flowing into the generator | O3 Press           |
| Photometer Pressure      | measures the pressure of gas in the photometer's absorption tube     | Photo Pressure     |
| Output Flow Pressure     | monitors the downstream regulator pressure                           | Regulator Pressure |

If the sensors detect a pressure outside the allowable range, an Alarm is triggered.

## 9.2. ELECTRONIC OPERATION

### 9.2.1. OVERVIEW

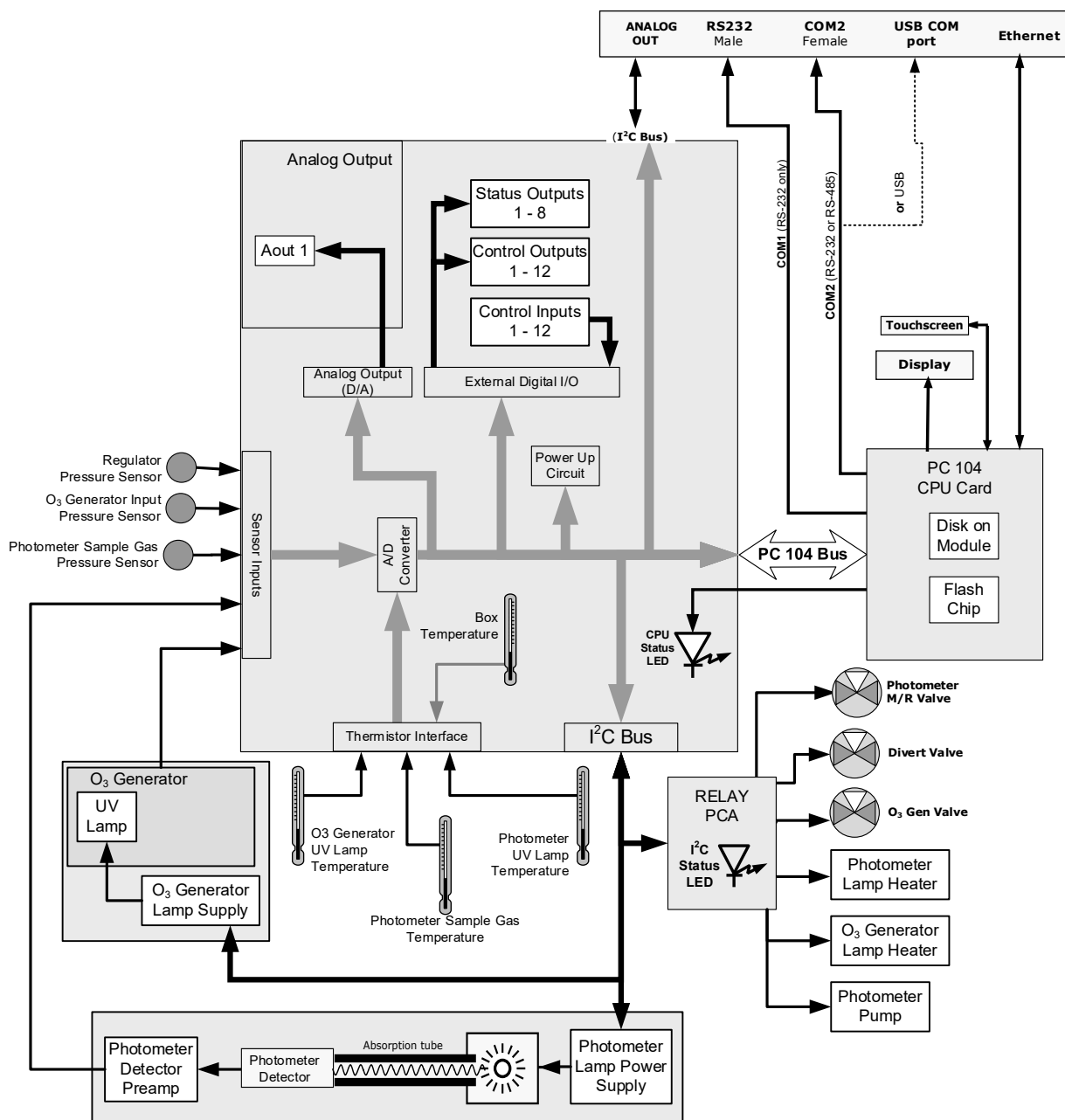

**Figure 9-2: Electronic Block Diagram**

The core of the calibrator is a microcomputer (referred to as the CPU) that controls various internal processes, interprets data, makes calculations, and reports results using specialized firmware developed by Teledyne API. It communicates with the user as well as receives data from and issues commands to a variety of peripheral devices via a separate printed circuit assembly called the motherboard.

The motherboard is directly mounted to the inside communications and output panel and collects data, performs signal conditioning duties and routes incoming and outgoing signals between the CPU and the calibrator's other major components.

Data are generated by the various sub components of the T753U (e.g. O<sub>3</sub> concentration from the photometer). Analog signals are converted into digital data by a unipolar, analog-to-digital converter, located on the motherboard.

A variety of sensors report the physical and operational status of the calibrator's major components, again through the signal processing capabilities of the motherboard. These status reports are used as data for the concentration calculations and as trigger events for certain control commands issued by the CPU. They are stored in memory by the CPU and in most cases can be viewed by the user via the Input and Control Panel display.

### 9.2.2. CENTRAL PROCESSING UNIT (CPU)

The unit's CPU card (Figure 9-3) is installed on the motherboard located inside the communications and output panel. It is a low power (5 VDC, 720mA max), high performance, Vortex 86SX-based microcomputer running Windows CE. Its operation and assembly conform to the PC-104 specification.

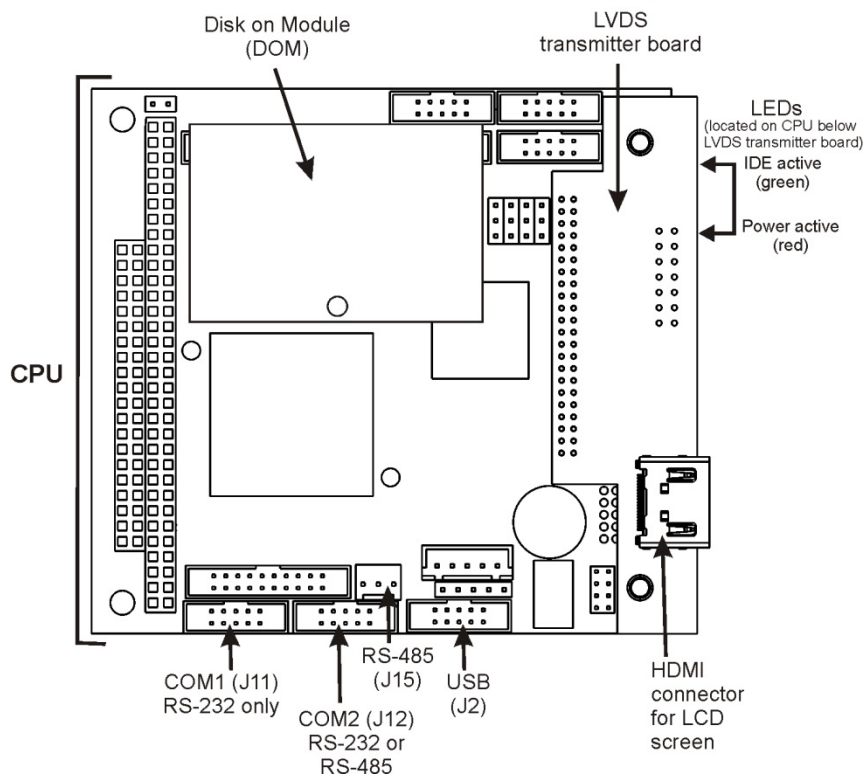

**Figure 9-3: CPU Board Annotated**

The CPU includes two types of non-volatile data storage: a Disk on Module (DOM) and an embedded flash chip.

### 9.2.2.1. Disk On Module (DOM)

The DOM is a 44-pin IDE flash chip with a storage capacity up to 256 MB. It is used to store the computer's operating system, the Teledyne API firmware, and most of the operational data.

### 9.2.2.2. Flash Chip

This non-volatile, embedded flash chip includes 2MB of storage for calibration data as well as a backup of the calibrator's configuration. Storing these key data onto a less frequently accessed chip significantly decreases the chance of data corruption.

In the unlikely event that the flash chip should fail, the calibrator will continue to operate with just the DOM. However, all configuration information will be lost, requiring the unit to be recalibrated.

### 9.2.3. POWER DISTRIBUTION BOARD

The power distribution board is one of the central switching and power distribution units of the calibrator. It contains power relays, valve drivers and status LEDs for all heated zones and valves, as well as thermocouple amplifiers, power distribution connectors and the two switching power supplies of the calibrator. The power distribution board communicates with the motherboard over the I<sup>2</sup>C bus. Its status indicators and components can be used for troubleshooting power problems and valve or heater functionality.

Generally, the power distribution board is mounted vertically on the backside of the same bracket as the instrument's DC power supplies.

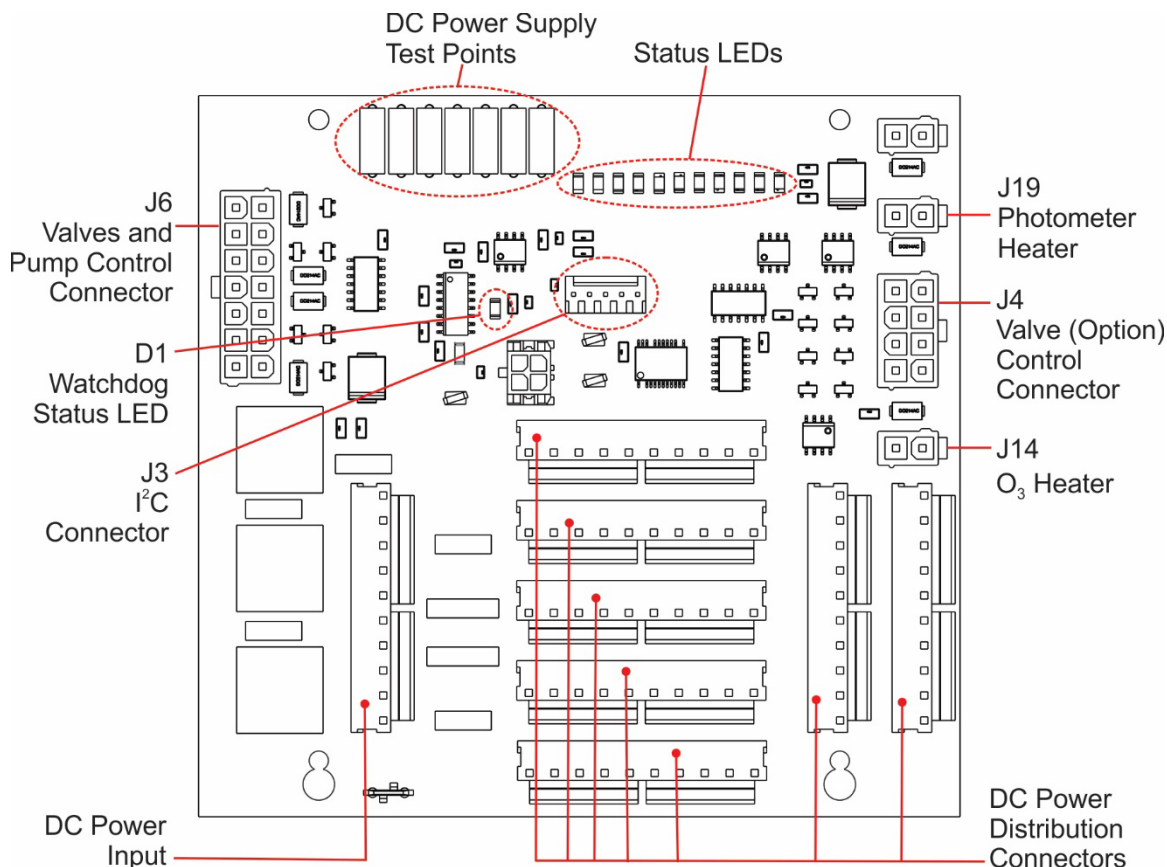

**Figure 9-4: Power Distribution Board**

**WARNING – ELECTRICAL SHOCK HAZARD**

Never remove this safety shield while the instrument is plugged in and turned on. The contacts of the AC relay sockets beneath the shield carry high AC voltages even when no relays are present.

**9.2.3.1. Valve Control**

The power distribution board also hosts two valve driver IC's, each of which can drive up four valves. In the T753U, the power distribution board controls only those valves associated with the O<sub>3</sub> generator and photometer.

In the T753U, the power distribution board controls two additional valves: the Divert valve and the O<sub>3</sub> Gen valve.

**9.2.3.2. Heater Control**

The power distribution board controls the DC heaters for the O<sub>3</sub> generator and photometer lamp housing.

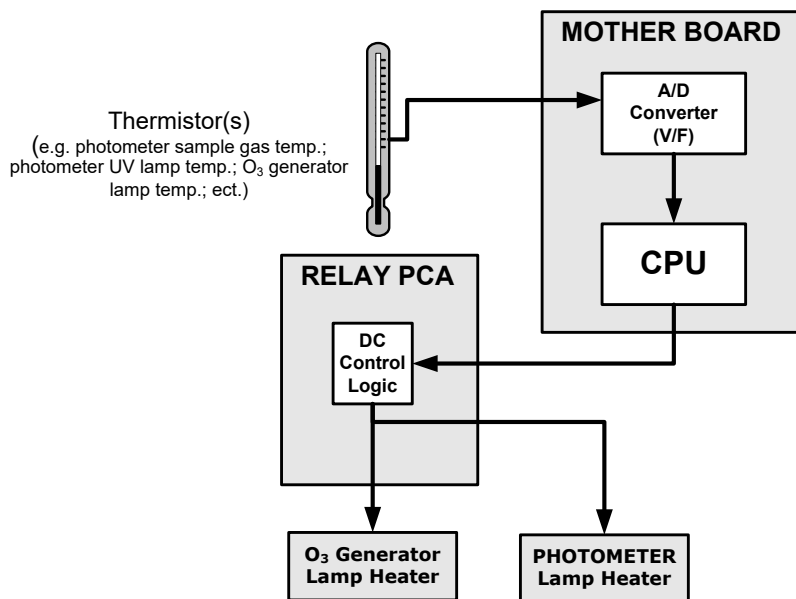
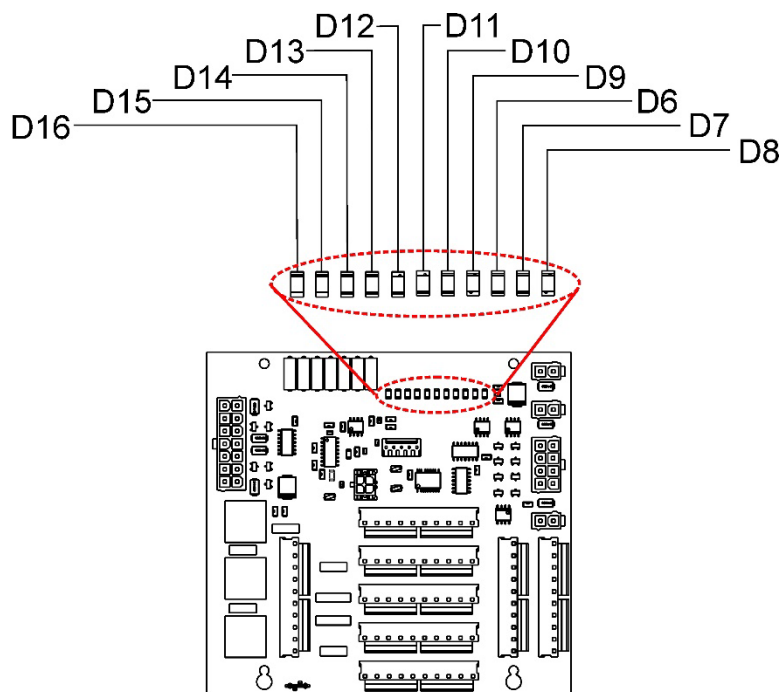

**Figure 9-5: Heater Control Loop Block Diagram.**

**9.2.3.3. Power Distribution Board Status LEDs and Watch Dog Circuitry**

Sixteen LEDs are located on the calibrator's power distribution board (Figure 9-6) to indicate the status of the calibrator's heating zones and some of its valves; included is a general operating watchdog indicator. Table 9-2 shows the states of these LEDs and their respective functionality. Not all LEDs are used.





**Figure 9-6: Status LED Locations – Power Distribution Board**

**Table 9-2: Power Distribution Board Status LEDs**

| LED  | DESCRIPTION                                       | FUNCTION                                                      |
|------|---------------------------------------------------|---------------------------------------------------------------|
| D1   | Watchdog Circuit; I <sup>2</sup> C bus operation. | Blinks when I <sup>2</sup> C bus is operating properly        |
| D2-6 | SPARE                                             |                                                               |
| D7   | Photometer Meas/Ref Valve                         | When lit, the valve opens the REFERENCE gas path              |
| D8   | External Zero Air Shutoff Valve                   | When lit, the valve open to O <sub>3</sub> generator gas path |
| D9   | O <sub>3</sub> Photometer Pump                    | When lit, the pump is turned on.                              |
| D10  | O <sub>3</sub> Divert Valve                       | When lit, the divert valve is open                            |
| D11  | O <sub>3</sub> Gen Valve                          | When lit, the valve is open.                                  |
| D12  | Internal Zero Air Pump                            | When lit, the pump is on.                                     |
| D13  | Internal Zero Air Pump Valve                      | When lit, the valve is open.                                  |
| D14  | SPARE                                             |                                                               |
| D15  | Photometer Heater                                 | When lit, the photometer UV lamp heater is on.                |
| D16  | O <sub>3</sub> Generator Heater                   | When lit, the O <sub>3</sub> generator UV lamp heater is on.  |

#### 9.2.3.4. Power Distribution Board Watchdog Indicator (D1)

The most important of the status LEDs on the power distribution board is the red I<sup>2</sup>C Bus watchdog LED. It is controlled directly by the calibrator's CPU over the I<sup>2</sup>C bus. Special circuitry on the power distribution board watches the status of D1. Should this LED ever

stay ON or OFF for 30 seconds (indicating that the CPU or I<sup>2</sup>C bus has stopped functioning) this Watchdog Circuit automatically shuts all valves and turns off all heaters and lamps.

#### 9.2.4. MOTHERBOARD

This is the largest electronic assembly in the calibrator and is mounted to the communications and output panel as the base for the CPU board and all I/O connectors. This printed circuit assembly provides a multitude of functions including A/D conversion, digital input/output, PC-104 to I<sup>2</sup>C translation, temperature sensor signal processing and is a pass through for the RS-232 and RS-485 signals.

#### 9.2.5. POWER SUPPLY AND CIRCUIT BREAKER

The calibrator operates in two main AC power ranges as presented in the specifications table. A 5-ampere circuit breaker is built into the ON/OFF switch. In case of a wiring fault or incorrect supply power, the circuit breaker will automatically turn off the calibrator.

**Note**

**The calibrator is equipped with a universal power supply that allows it to accept any AC power configuration, within the limits listed in the specifications table.**

**WARNING – Electrical Shock Hazard**

**Should the AC power circuit breaker trip, investigate and correct the condition causing this situation before powering on the calibrator again.**

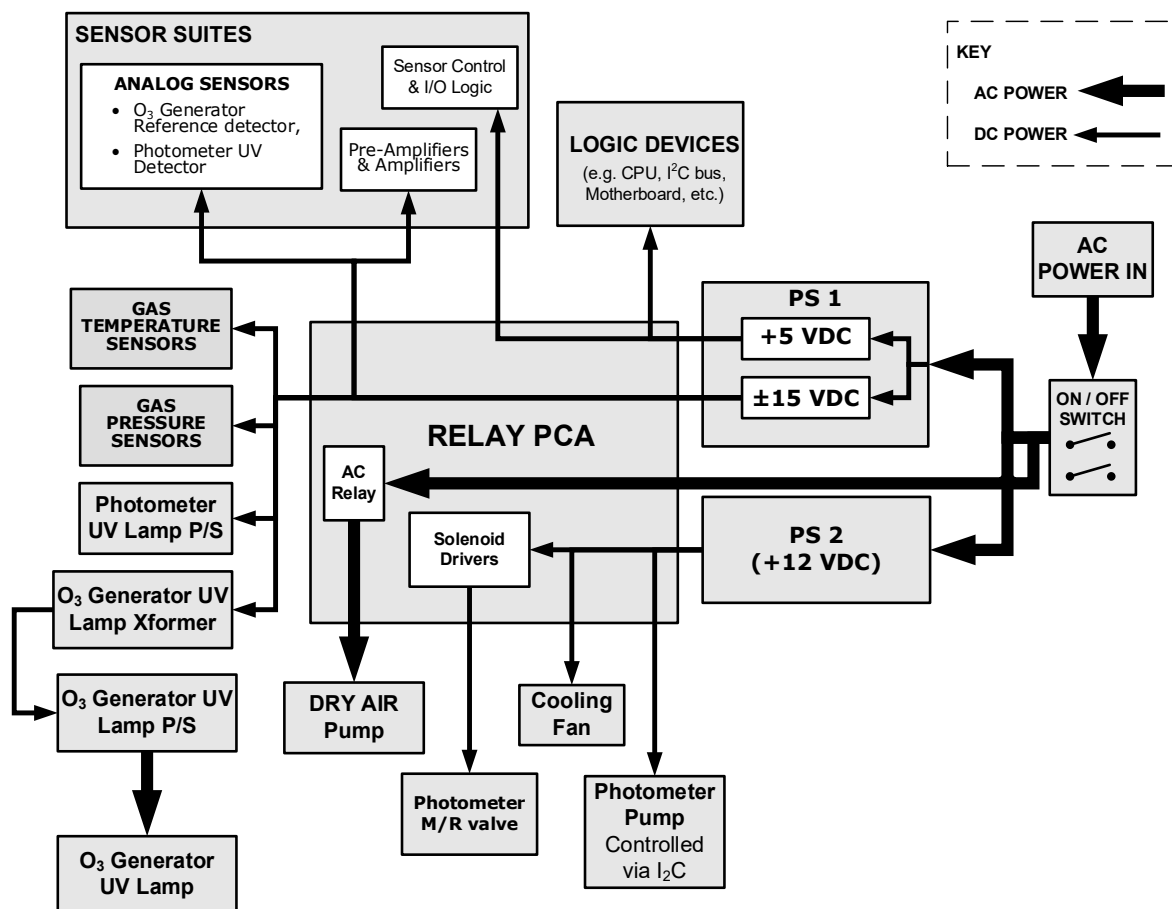

Figure 9-7: Power Distribution Block diagram

### 9.2.6. INTERNAL ZERO AIR PUMP DC CONNECTIONS

The internal zero air pump is a dual head 12 VDC pump. Figure 9-8 shows the location of the internal zero air pump’s DC connection. Terminal J6 pins 3 and 4 provide the signal to activate/deactivate the 12 VDC internal zero air pump.

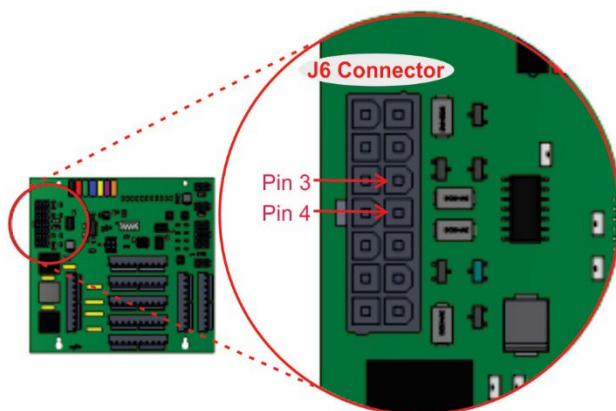
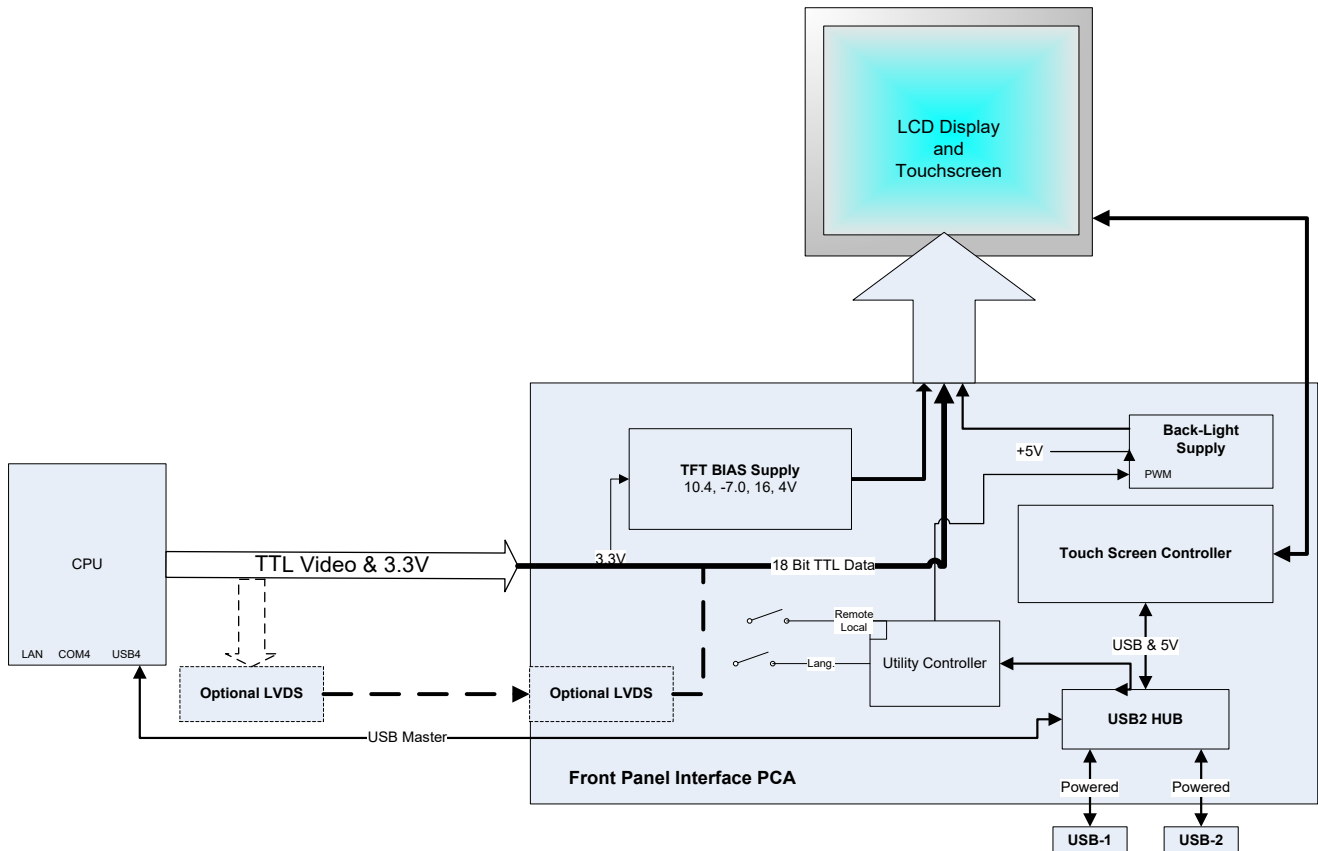

Figure 9-8: Internal Z/A Pump DC Connection

### 9.3. INPUT AND CONTROL PANEL TOUCHSCREEN/DISPLAY INTERFACE

The most commonly used method for communicating with the T753U Portable Calibrator is via the instrument's Input and Control Panel LCD touchscreen display. The LCD display is controlled directly by the CPU board. The touchscreen is interfaced to the CPU by means of a touchscreen controller that connects to the CPU via the internal USB bus and emulates a computer mouse.



**Figure 9-9: Input and Control Panel Layout**

The LCD display is controlled directly by the CPU board. The touchscreen is interfaced to the CPU by means of a touchscreen controller that connects to the CPU via the internal USB bus and emulates a computer mouse.

#### 9.3.1.1. Input and Control Panel Interface PCA

The Input and Control Panel interface PCA controls the various functions of the display and touchscreen. For driving the display it provides connection between the CPU video controller and the LCD display module. This PCA also contains:

- power supply circuitry for the LCD display module
- USB hub that is used for communications with the touchscreen controller and the two Input and Control Panel USB device ports
- circuitry for powering the display backlight

## 9.4. SOFTWARE OPERATION

The calibrator's core module is a high performance, Vortex 86SX-based microcomputer running Windows CE. Inside Windows CE, special software developed by Teledyne API interprets user commands from the various interfaces, performs procedures and tasks, stores data in the CPU's various memory devices, and calculates the concentration of the gas being sampled.

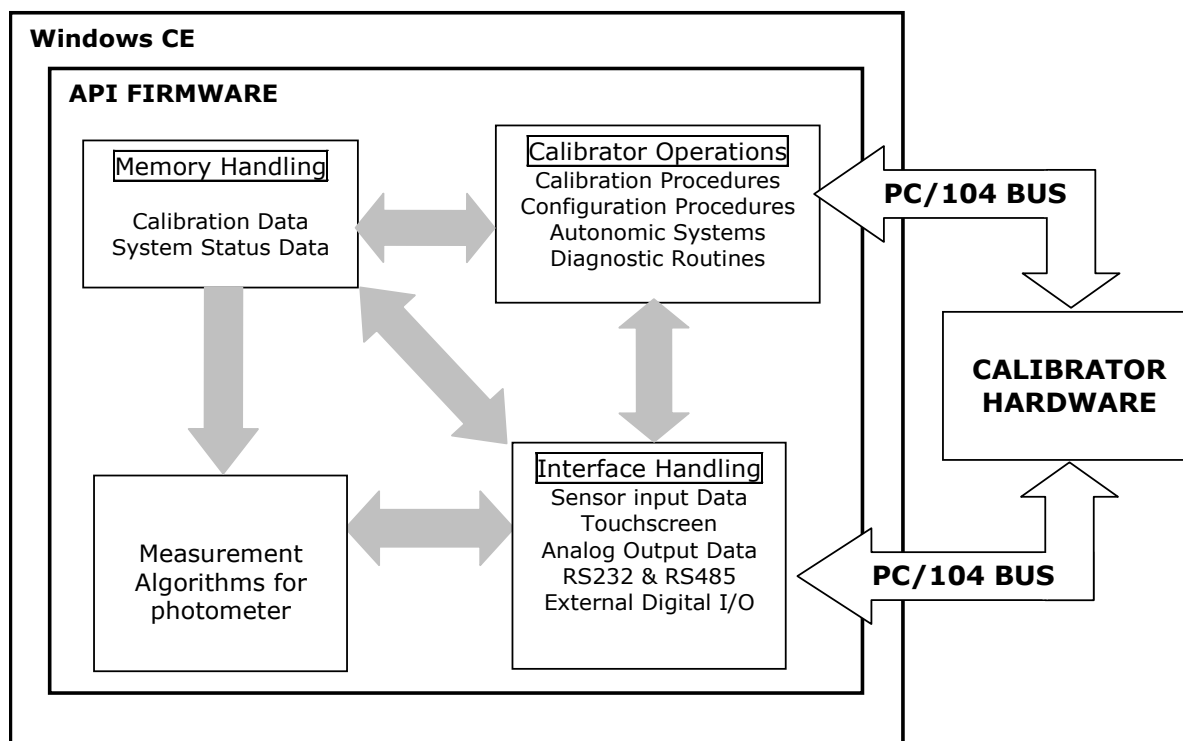

Figure 9-10: Schematic of Basic Software Operation

## 9.5. O<sub>3</sub> GENERATOR OPERATION

### 9.5.1. PRINCIPLE OF PHOTOLYTIC O<sub>3</sub> GENERATION

Ozone is a naturally occurring substance made up of three atoms of oxygen (O<sub>3</sub>). Because of its relatively short half-life, ozone cannot be bottled and stored for later use and therefore must always be generated on-site by an ozone generator. The two main principles of ozone generation are UV-light and corona discharge. While the corona-discharge method is most common because of its ability to generate very high concentrations (up to 50%), the UV-light method is most feasible in calibration applications where low, accurate concentrations of ozone are desired. This method mimics the radiation method that occurs naturally from the sun in the upper atmosphere producing the ozone layer. An ultra-violet lamp inside the generator emits a precise wavelength of UV Light (185 nm). Ambient air is passed over an ultraviolet lamp, which splits some of the molecular oxygen (O<sub>2</sub>) in the gas into individual oxygen atoms which attach to other existing oxygen molecules (O<sub>2</sub>), forming ozone (O<sub>3</sub>).

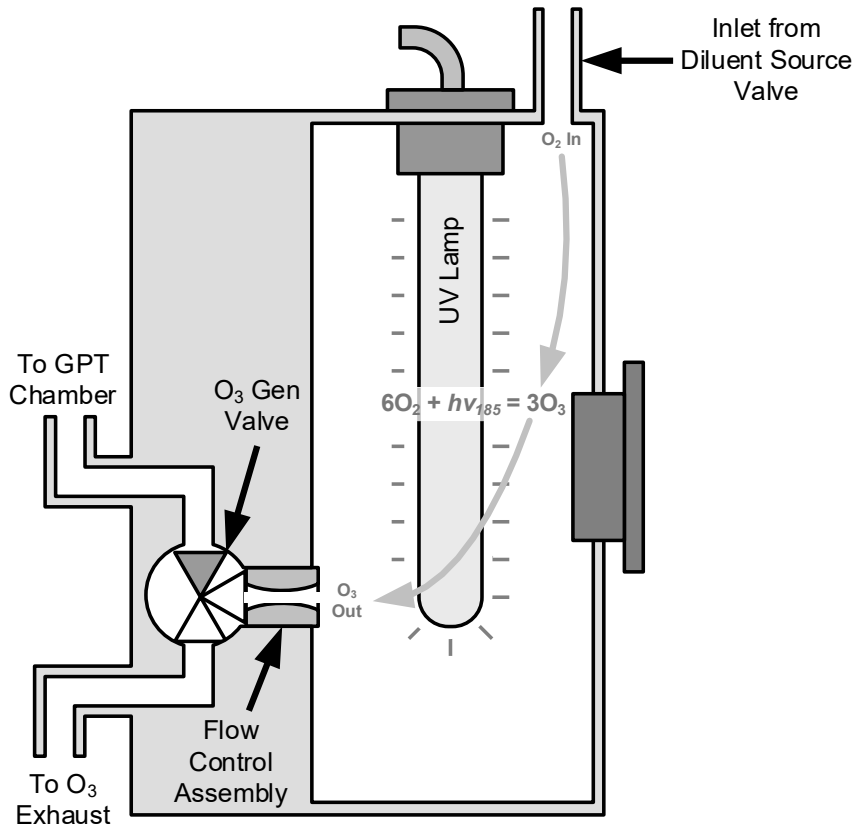

Figure 9-11: O<sub>3</sub> Generator Internal Pneumatics

### 9.5.2. GENERATOR PNEUMATIC OPERATION

The rate of flow through the O<sub>3</sub> generator is controlled by a flow control assembly located on the Regulator Sub-Assembly in the front of the calibrator.

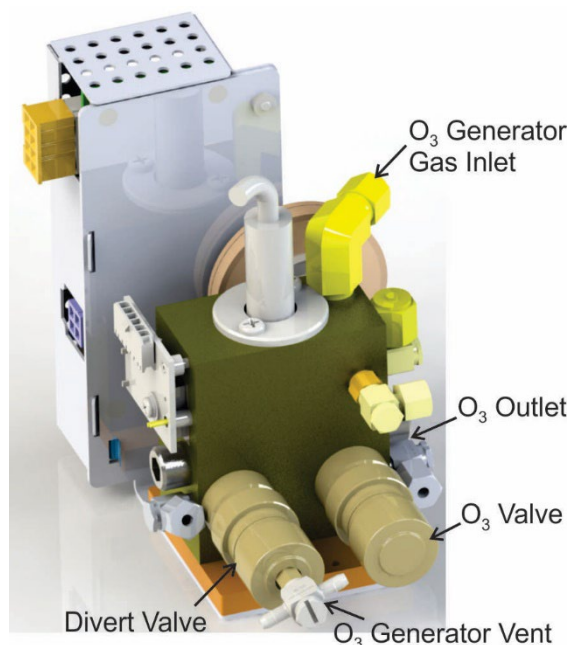

Figure 9-12: O<sub>3</sub> Generator Valve and Gas Fixture Locations

### 9.5.3. O<sub>3</sub> GENERATOR ELECTRONIC OPERATION

Electronically the O<sub>3</sub> generator and its subcomponents act as peripheral devices operated by the CPU via the motherboard. Sensor signals, such as the UV lamp thermistor are routed to the motherboard, where they are digitized. Digital data is sent by the motherboard to the calibrator's CPU and where required stored in either flash memory or on the CPU's disk-on-chip. Commands from the CPU are sent to the motherboard and forwarded to the various devices via the calibrator's I<sup>2</sup>C bus.

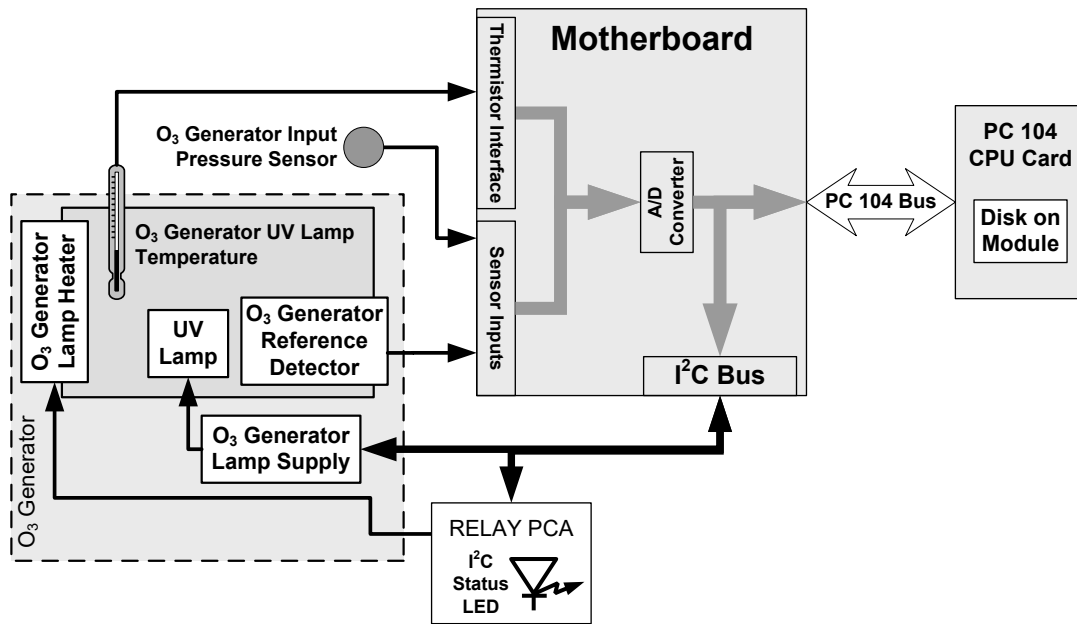

Figure 9-13: O<sub>3</sub> Generator Electronic Block Diagram

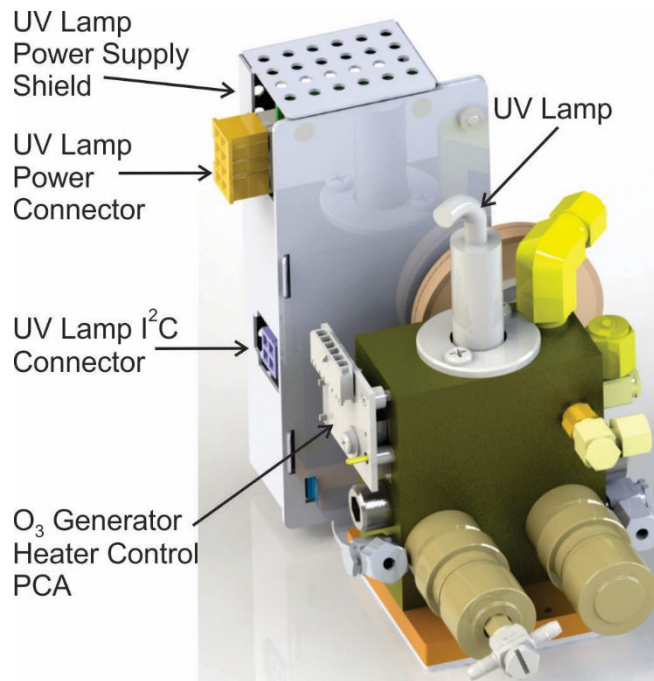

Figure 9-14: O<sub>3</sub> Generator Electronic Components Location



### 9.5.3.1. O<sub>3</sub> Generator Temperature Control

In order to operate at peak efficiency the UV lamp of the O<sub>3</sub> generator is maintained at a constant 48°C. If the lamp temperature falls below 43°C or rises above 53°C a warning is issued by the CPU.

This temperature is controlled as described in the section on the power distribution board (see Section 9.2.3.2). The location of the thermistor and heater associated with the O<sub>3</sub> generator is shown below:

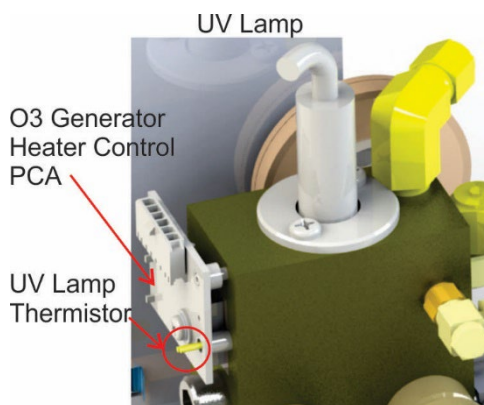

**Figure 9-15: O<sub>3</sub> Generator Temperature Thermistor and DC Heater Locations**

## 9.6. PHOTOMETER OPERATION

The calibrator's photometer determines the concentration of Ozone (O<sub>3</sub>) in a sample gas drawn through it. Sample and calibration gasses must be supplied at ambient atmospheric pressure in order to establish a stable gas flow through the absorption tube where the gas' ability to absorb ultraviolet (UV) radiation of a certain wavelength (in this case 254 nm) is measured.

Gas bearing O<sub>3</sub> and zero air are alternately routed through the photometer's absorption tube. Measurements of the UV light passing through the sample gas with and without O<sub>3</sub> present are made and recorded.

Calibration of the photometer is performed in software and does not require physical adjustments. Two internal variables, a slope and offset are used to adjust the calibration of the photometer.

The CPU uses these calibration values, the UV absorption measurements made on the sample gas in the absorption tube along with data regarding the current temperature and pressure of the gas to calculate a final O<sub>3</sub> concentration.

## 9.6.1. MEASUREMENT METHOD

### 9.6.1.1. Calculating O<sub>3</sub> Concentration

The basic principle by which photometer works is called Beer's Law (also referred to as the Beer-Lambert equation). It defines the how light of a specific wavelength is absorbed by a particular gas molecule over a certain distance at a given temperature and pressure. The mathematical relationship between these three parameters for gasses at Standard Temperature and Pressure (STP) is:

**Equation 9-5**

$$I = I_o e^{-\alpha LC} \quad \text{at STP}$$

Where:

***I*<sub>o</sub>** is the intensity of the light if there was no absorption.

***I*** is the intensity with absorption.

***L*** is the absorption path, or the distance the light travels as it is being absorbed.

***C*** is the concentration of the absorbing gas. In the case of the Model T753U, Ozone (O<sub>3</sub>).

***α*** is the absorption coefficient that tells how well O<sub>3</sub> absorbs light at the specific wavelength of interest.

To solve this equation for ***C***, the concentration of the absorbing Gas (in this case O<sub>3</sub>), the application of a little algebra is required to rearrange the equation as follows:

**Equation 9-6**

$$C = \ln\left(\frac{I_o}{I}\right) \times \left(\frac{1}{\alpha L}\right) \quad \text{at STP}$$

Unfortunately, both ambient temperature and pressure influence the density of the sample gas and therefore the number of ozone molecules present in the absorption tube thus changing the amount of light absorbed.

In order to account for this effect the following addition is made to the equation:

**Equation 9-7**

$$C = \ln\left(\frac{I_o}{I}\right) \times \left(\frac{1}{\alpha L}\right) \times \left(\frac{T}{273 \text{ K}} \times \frac{29.92 \text{ inHg}}{P}\right)$$

Where:

***T*** = sample ambient temperature in degrees Kelvin

***P*** = ambient pressure in inches of mercury

Finally, to convert the result into Parts per Billion (PPB), the following change is made:

**Equation 9-8**

$$C = \ln\left(\frac{I_o}{I}\right) \times \left(\frac{10^9}{\alpha L}\right) \times \left(\frac{T}{273 \text{ K}} \times \frac{29.92 \text{ inHg}}{P}\right)$$

In summary, the photometer:

- Measures each of the above variables: ambient temperature; ambient gas pressure; the intensity of the UV light beam with and without O<sub>3</sub> present;
- Inserts know values for the length of the absorption path and the absorption coefficient, and:
- Calculates the concentration of O<sub>3</sub> present in the sample gas.

### 9.6.1.2. The Measurement / Reference Cycle

In order to solve the Beer-Lambert equation it is necessary to know the intensity of the light passing through the absorption path both when O<sub>3</sub> is present and when it is not. A valve called the measure/reference valve, physically located on front-left corner of the O<sub>3</sub> generator assembly (see Figures 3-4 and 9-14) alternates the gas stream flowing to the photometer between zero air (diluent gas) and the O<sub>3</sub> output from the O<sub>3</sub> generator. This cycle takes about 6 seconds.

**Table 9-3: Photometer Measurement / Reference Cycle**

| <b>TIME INDEX</b>                   | <b>STATUS</b>                                                                                                                          |
|-------------------------------------|----------------------------------------------------------------------------------------------------------------------------------------|
| 0 sec.                              | Measure/Reference Valve Opens to the Measure Path.                                                                                     |
| 0 – 2 sec.                          | Wait Period. Ensures that the Absorption tube has been adequately flushed of any previously present gasses.                            |
| 2 – 3 sec.                          | Analyzer measures the average UV light intensity of O <sub>3</sub> bearing Sample Gas ( <b>I</b> ) during this period.                 |
| 3 sec.                              | Measure/Reference Valve Opens to the Reference Path.                                                                                   |
| 3 – 5 sec.                          | Wait Period. Ensures that the Absorption tube has been adequately flushed of O <sub>3</sub> bearing gas.                               |
| 5 – 6 sec.                          | Analyzer measures the average UV light intensity of Non-O <sub>3</sub> bearing Sample Gas ( <b>I<sub>0</sub></b> ) during this period. |
| <b>CYCLE REPEAT EVERY 6 SECONDS</b> |                                                                                                                                        |

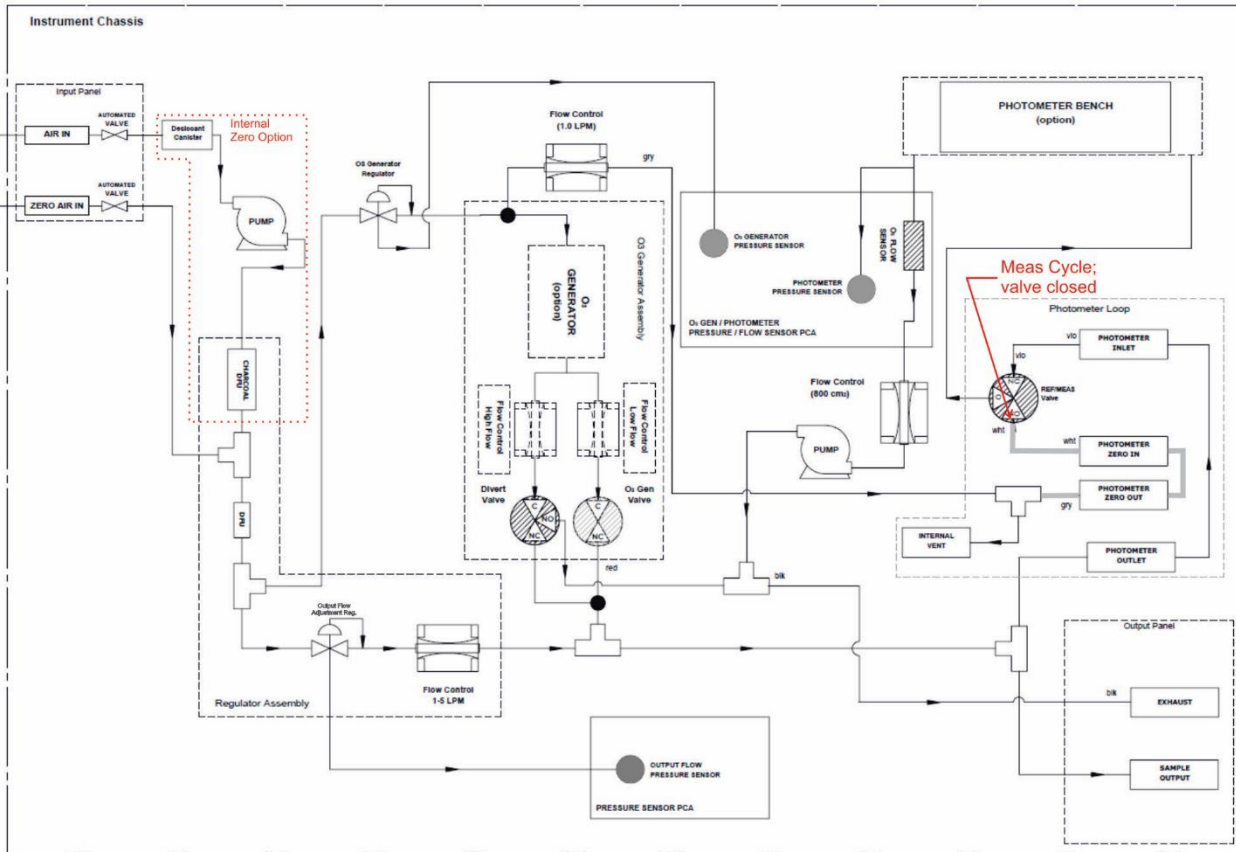

Figure 9-16: T753U O<sub>3</sub> Photometer Gas Flow – Measure Cycle

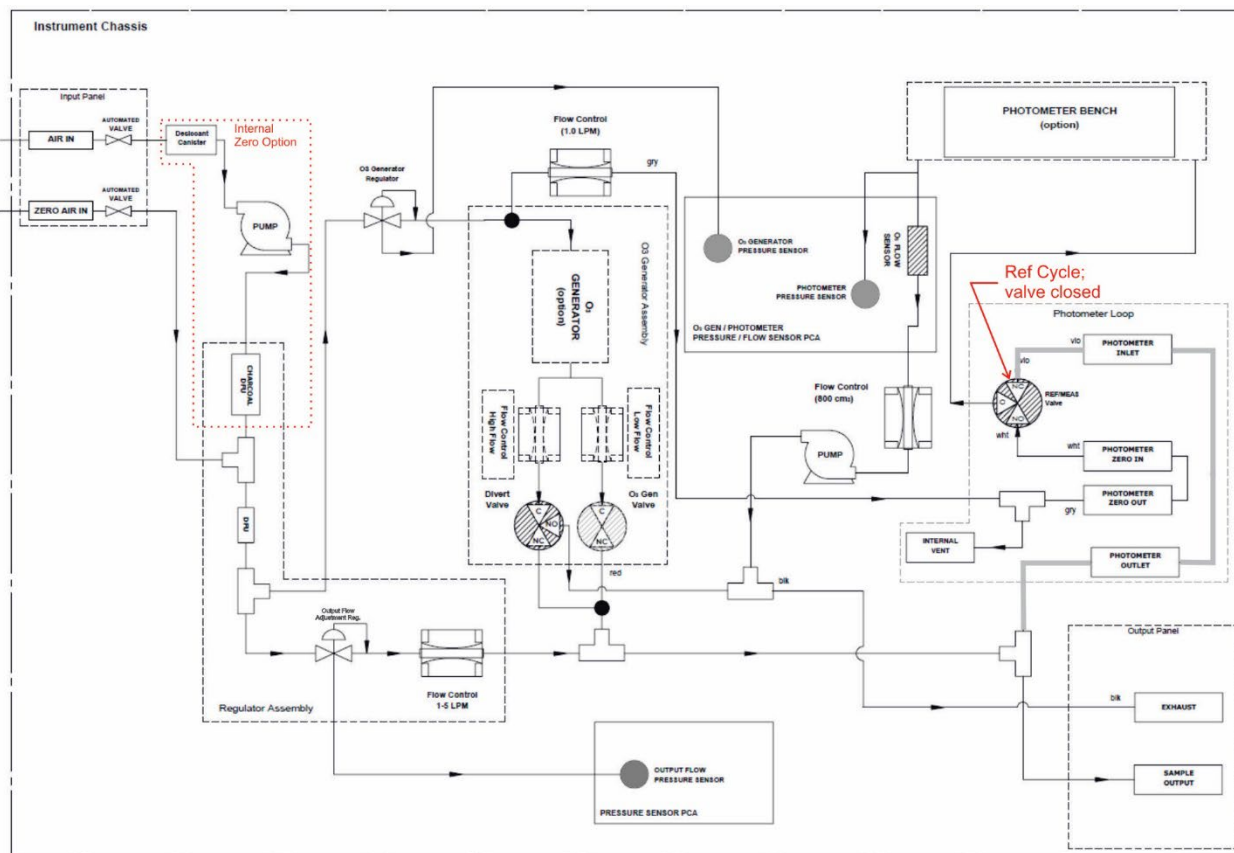

Figure 9-17: T753U O<sub>3</sub> Photometer Gas Flow – Reference Cycle

### 9.6.1.3. The Absorption Path

In the most basic terms, the photometer uses a high energy, mercury vapor lamp to generate a beam of UV light. This beam passes through a window of material specifically chosen to be both non-reactive to O<sub>3</sub> and transparent to UV radiation at 254nm and into an absorption tube filled with sample gas.

Because ozone is a very efficient absorber of UV radiation the absorption path length required to create a measurable decrease in UV intensity is short enough (approximately 37.6 cm) that the light beam is only required to make one pass through the Absorption Tube. Therefore, no complex mirror system is needed to lengthen the effective path by bouncing the beam back and forth.

Finally, the UV passes through a similar window at the other end of the absorption tube and is detected by a specially designed vacuum diode that only detects radiation at or very near a wavelength of 254nm. The specificity of the detector is high enough that no extra optical filtering of the UV light is needed.

The detector reacts to the UV light and outputs a current signal that varies in direct relationship with the intensity of the light shining on it. This current signal is amplified and converted to a 0 to 5 VDC voltage analog signal voltage sent to the instrument's motherboard where it is digitized. The CPU uses this digital data in computing the concentration of O<sub>3</sub> in the absorption tube.

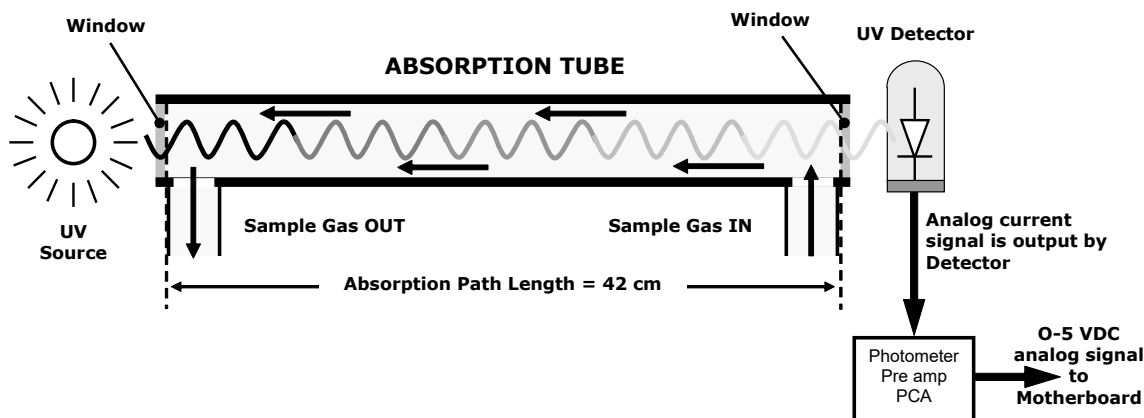

Figure 9-18: O<sub>3</sub> Photometer Absorption Path

#### 9.6.1.4. Interferent Rejection

It should be noted that the UV absorption method for detecting ozone is subject to interference from a number of sources. The photometer has been successfully tested for its ability to reject interference from sulfur dioxide, nitrogen dioxide, nitric oxide, water, and meta-xylene.

While the photometer rejects interference from the aromatic hydrocarbon meta-xylene, it should be noted that there are a very large number of other volatile aromatic hydrocarbons that could potentially interfere with ozone detection. If the calibrator is installed in an environment where high aromatic hydrocarbon concentrations are suspected, specific tests should be conducted to reveal the amount of interference these compounds may be causing.

#### 9.6.2. PHOTOMETER LAYOUT

The Photometer is where the absorption of UV light by ozone is measured and converted into a voltage. It consists of several sub-assemblies:

- A mercury-vapor UV lamp. This lamp is coated in a material that optically screens the UV radiation output to remove the O<sub>3</sub> producing 185nm radiation. Only light at 254nm is emitted.
- An AC power supply that supplies the current for starting and maintaining the plasma arc of the mercury vapor lamp.
- A thermistor and DC heater attached to the UV Lamp to maintain the Lamp at an optimum operating temperature.
- 42 cm long quartz absorption tube.
- A thermistor attached to the quartz tube for measuring sample gas temperature.
- Gas inlet and outlet mounting blocks that rout sample gas into and out of the photometer.
- The vacuum diode, UV detector that converts UV light to a DC current.
- A preamplifier assembly, which convert the Detector's current output into a DC Voltage then amplifies it to a level readable by the A to D converter circuitry of the instrument's motherboard

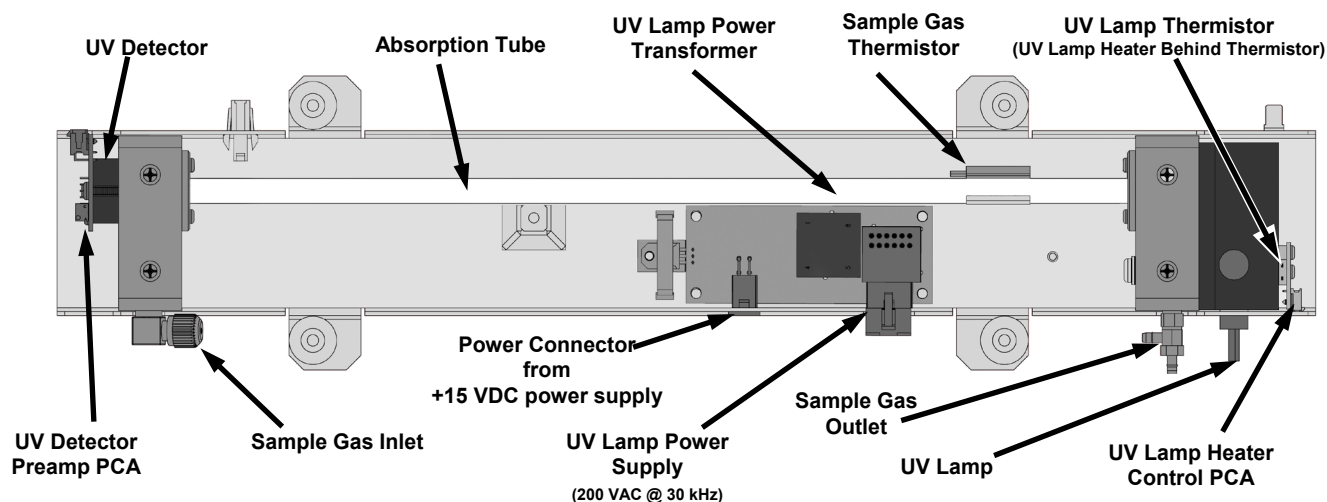

Figure 9-19: O<sub>3</sub> Photometer Layout – Top Cover Removed

### 9.6.3. PHOTOMETER PNEUMATIC OPERATION

The flow of gas through the photometer is created by an internal pump that pulls air through the instrument. There are several advantages to this “pull through” configuration. Placing the pump downstream from the absorption tube avoids problems caused by the pumping process heating and compressing the sample.

In order to measure accurately the presences of low concentrations of O<sub>3</sub> in the sample air it is necessary to establish and maintain a relatively constant and stable volumetric flow of sample gas through the photometer. The simplest way to accomplish this is by placing a flow control assembly containing a critical flow orifice directly upstream of the pump but downstream from the absorption tube.

The critical flow orifice installed in the pump supply line is tuned to create a gas flow of 800 cm<sup>3</sup>/min. A pressure sensor and a flow sensor, located on the O<sub>3</sub> generator / photometer pressure flow sensor PCA, monitor the pressure and flow rate of the gas passing through the photometers absorption tube.

See Figure 9-18 for depictions of the gas flow related to the photometer.

### 9.6.4. PHOTOMETER ELECTRONIC OPERATION

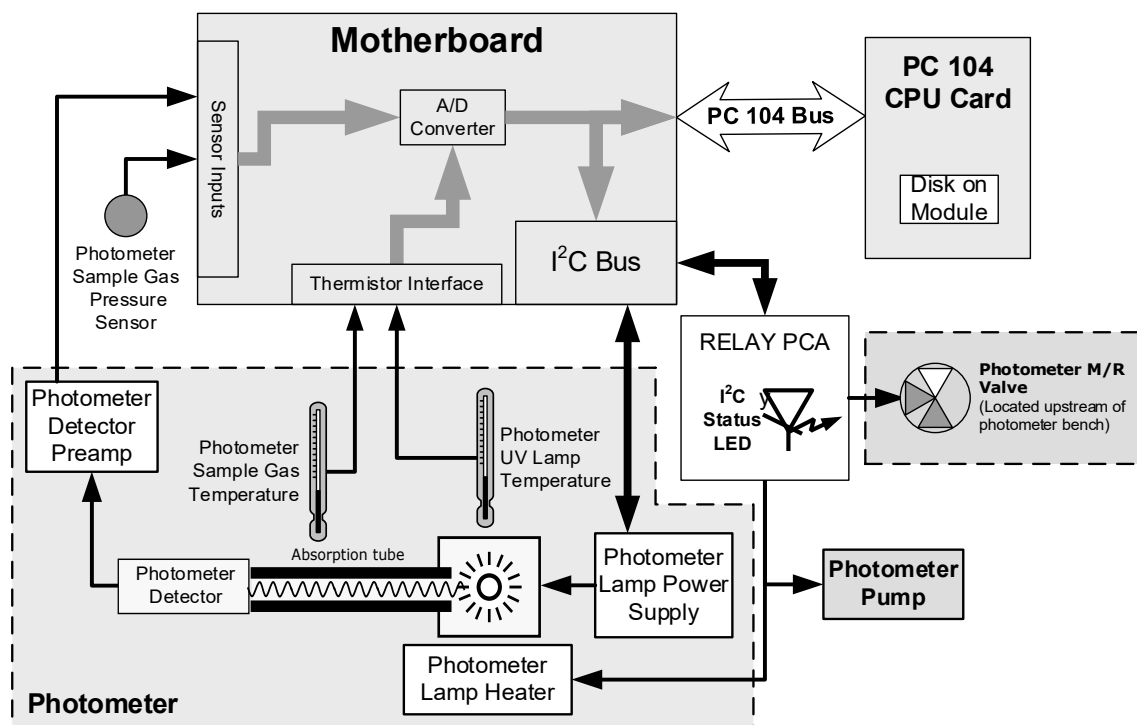

**Figure 9-20: O<sub>3</sub> Photometer Electronic Block Diagram**

Like the O<sub>3</sub> generator, the O<sub>3</sub> photometer and its subcomponents act as peripheral devices operated by the CPU via the motherboard. Communications to and from the CPU are handled by the motherboard.

Outgoing commands for the various devices such as the photometer pump, the UV lamp power supply the UV Lamp heater are issued via the I<sup>2</sup>C bus to circuitry on the power distribution board which turns them ON/OFF. The CPU also issues commands over the I<sup>2</sup>C bus that cause the power distribution board to cycle the measure/reference valve back and forth.

Incoming data from the the UV light detector is amplified locally then converted to digital information by the motherboard. Output from the photometers temperature sensors is also amplified and converted to digital data by the motherboard. The O<sub>3</sub> concentration of the sample gas is computed by the CPU using this data (along with gas pressure and flow data received from the pressure sensors).



### 9.6.4.1. O<sub>3</sub> Photometer Temperature Control

In order to operate at peak efficiency the UV lamp of the O<sub>3</sub> photometer is maintained at a constant 58°C. This is intentionally set at a temperature higher than the ambient temperature of the operating environment to make sure that local changes in temperature do not affect the UV Lamp. If the lamp temperature falls below 56°C or rises above 61°C a warning is issued by the calibrator's CPU.

This temperature is controlled as described in the section on the power distribution board (Section 9.2.3.2).

The following TEST functions report these temperatures and are viewable from the instrument's Input and Control Panel:

- **PHOTO LAMP TEMP** - The temperature of the UV Lamp reported in °C.
- **PHOTO STEMP** - The temperature of the Sample gas in the absorption tube reported in °C.

### 9.6.4.2. Pneumatic Sensors for the O<sub>3</sub> Photometer

The several sensors located on the pneumatic sensor just to the left rear of the O<sub>3</sub> generator assembly measure the absolute pressure and the flow rate of gas inside the photometer's absorption tube. This information is used by the CPU to calculate the O<sub>3</sub> concentration of the sample gas (See Equation 9-7). Both of these measurements are made downstream from the absorption tube but upstream of the pump. A critical flow orifice located between the flow sensor and the pump maintains the gas flow through the photometer at 800 cm<sup>3</sup>/min.

The following TEST functions are viewable from the instrument's Input and Control Panel:

- **PHOTO FLOW** - The flow rate of gas through the photometer measured in LPM.
- **PHOTO SPRESS** – the pressure of the gas inside the absorption tube. This pressure is reported in inches of mercury-absolute (**in-Hg-A**), i.e. referenced to a vacuum (zero absolute pressure). This is not the same as **PSIG**.

## GLOSSARY

Some terms in this glossary may not occur elsewhere in this manual.

| TERM                                                     | DESCRIPTION/DEFINITION                                                                                                                                                                                                                       |
|----------------------------------------------------------|----------------------------------------------------------------------------------------------------------------------------------------------------------------------------------------------------------------------------------------------|
| 10BaseT                                                  | an Ethernet standard that uses twisted ("T") pairs of copper wires to transmit at 10 megabits per second (Mbps)                                                                                                                              |
| 100BaseT                                                 | same as 10BaseT except ten times faster (100 Mbps)                                                                                                                                                                                           |
| ASSY                                                     | <i>Assembly</i>                                                                                                                                                                                                                              |
| CAS                                                      | <i>Code-Activated Switch</i>                                                                                                                                                                                                                 |
| CD                                                       | <i>Corona Discharge</i> , a frequently luminous discharge, at the surface of a conductor or between two conductors of the same transmission line, accompanied by ionization of the surrounding atmosphere and often by a power loss          |
| CE                                                       | <i>Converter Efficiency</i> , the percentage of light energy that is actually converted into electricity                                                                                                                                     |
| CEM                                                      | <i>Continuous Emission Monitoring</i>                                                                                                                                                                                                        |
| Chemical formulas that may be included in this document: |                                                                                                                                                                                                                                              |
| CO <sub>2</sub>                                          | carbon dioxide                                                                                                                                                                                                                               |
| C <sub>3</sub> H <sub>8</sub>                            | propane                                                                                                                                                                                                                                      |
| CH <sub>4</sub>                                          | methane                                                                                                                                                                                                                                      |
| H <sub>2</sub> O                                         | water vapor                                                                                                                                                                                                                                  |
| HC                                                       | general abbreviation for hydrocarbon                                                                                                                                                                                                         |
| HNO <sub>3</sub>                                         | nitric acid                                                                                                                                                                                                                                  |
| H <sub>2</sub> S                                         | hydrogen sulfide                                                                                                                                                                                                                             |
| NO                                                       | nitric oxide                                                                                                                                                                                                                                 |
| NO <sub>2</sub>                                          | nitrogen dioxide                                                                                                                                                                                                                             |
| NO <sub>x</sub>                                          | nitrogen oxides, here defined as the sum of NO and NO <sub>2</sub>                                                                                                                                                                           |
| NO <sub>y</sub>                                          | nitrogen oxides, often called odd nitrogen: the sum of NO <sub>x</sub> plus other compounds such as HNO <sub>3</sub> (definitions vary widely and may include nitrate (NO <sub>3</sub> ), PAN, N <sub>2</sub> O and other compounds as well) |
| NH <sub>3</sub>                                          | ammonia                                                                                                                                                                                                                                      |
| O <sub>2</sub>                                           | molecular oxygen                                                                                                                                                                                                                             |
| O <sub>3</sub>                                           | ozone                                                                                                                                                                                                                                        |
| SO <sub>2</sub>                                          | sulfur dioxide                                                                                                                                                                                                                               |
| cm <sup>3</sup>                                          | metric abbreviation for <i>cubic centimeter</i> (replaces the obsolete abbreviation "cc")                                                                                                                                                    |
| CPU                                                      | <i>Central Processing Unit</i>                                                                                                                                                                                                               |
| DAC                                                      | <i>Digital-to-Analog Converter</i>                                                                                                                                                                                                           |
| DAS                                                      | <i>Data Acquisition System</i>                                                                                                                                                                                                               |
| DCE                                                      | <i>Data Communication Equipment</i>                                                                                                                                                                                                          |
| DFU                                                      | <i>Dry Filter Unit</i>                                                                                                                                                                                                                       |
| DHCP                                                     | <i>Dynamic Host Configuration Protocol</i> . A protocol used by LAN or Internet servers to automatically set up the interface protocols between themselves and any other addressable device connected to the network                         |
| DIAG                                                     | <i>Diagnostics</i> , the diagnostic settings of the instrument.                                                                                                                                                                              |
| DOM                                                      | <i>Disk On Module</i> , a 44-pin IDE flash drive with up to 128MB storage capacity for instrument's firmware, configuration settings and data                                                                                                |

| TERM                 | DESCRIPTION/DEFINITION                                                                                                                                                                                                                                                                                                                                                                                                                                                     |
|----------------------|----------------------------------------------------------------------------------------------------------------------------------------------------------------------------------------------------------------------------------------------------------------------------------------------------------------------------------------------------------------------------------------------------------------------------------------------------------------------------|
| DOS                  | <i>Disk Operating System</i>                                                                                                                                                                                                                                                                                                                                                                                                                                               |
| DRAM                 | <i>Dynamic Random Access Memory</i>                                                                                                                                                                                                                                                                                                                                                                                                                                        |
| DR-DOS               | <i>Digital Research DOS</i>                                                                                                                                                                                                                                                                                                                                                                                                                                                |
| DTE                  | <i>Data Terminal Equipment</i>                                                                                                                                                                                                                                                                                                                                                                                                                                             |
| EEPROM               | <i>Electrically Erasable Programmable Read-Only Memory</i> also referred to as a FLASH chip or drive                                                                                                                                                                                                                                                                                                                                                                       |
| ESD                  | <i>Electro-Static Discharge</i>                                                                                                                                                                                                                                                                                                                                                                                                                                            |
| ETEST                | <i>Electrical Test</i>                                                                                                                                                                                                                                                                                                                                                                                                                                                     |
| Ethernet             | a standardized (IEEE 802.3) computer networking technology for local area networks (LANs), facilitating communication and sharing resources                                                                                                                                                                                                                                                                                                                                |
| FEP                  | <i>Fluorinated Ethylene Propylene</i> polymer, one of the polymers that Du Pont markets as <i>Teflon</i> <sup>®</sup>                                                                                                                                                                                                                                                                                                                                                      |
| Flash                | non-volatile, solid-state memory                                                                                                                                                                                                                                                                                                                                                                                                                                           |
| FPI                  | <i>Fabry-Perot Interface</i> : a special light filter typically made of a transparent plate with two reflecting surfaces or two parallel, highly reflective mirrors                                                                                                                                                                                                                                                                                                        |
| GFC                  | <i>Gas Filter Correlation</i>                                                                                                                                                                                                                                                                                                                                                                                                                                              |
| I <sup>2</sup> C bus | a clocked, bi-directional, serial bus for communication between individual instrument components                                                                                                                                                                                                                                                                                                                                                                           |
| IC                   | <i>Integrated Circuit</i> , a modern, semi-conductor circuit that can contain many basic components such as resistors, transistors, capacitors etc in a miniaturized package used in electronic assemblies                                                                                                                                                                                                                                                                 |
| IP                   | <i>Internet Protocol</i>                                                                                                                                                                                                                                                                                                                                                                                                                                                   |
| IZS                  | <i>Internal Zero Span</i>                                                                                                                                                                                                                                                                                                                                                                                                                                                  |
| LAN                  | <i>Local Area Network</i>                                                                                                                                                                                                                                                                                                                                                                                                                                                  |
| LCD                  | <i>Liquid Crystal Display</i>                                                                                                                                                                                                                                                                                                                                                                                                                                              |
| LED                  | <i>Light Emitting Diode</i>                                                                                                                                                                                                                                                                                                                                                                                                                                                |
| LPM                  | <i>Liters Per Minute</i>                                                                                                                                                                                                                                                                                                                                                                                                                                                   |
| M/R                  | <i>Measure/Reference</i>                                                                                                                                                                                                                                                                                                                                                                                                                                                   |
| MOLAR MASS           | the mass, expressed in grams, of 1 mole of a specific substance. Conversely, one mole is the amount of the substance needed for the molar mass to be the same number in grams as the atomic mass of that substance.<br>EXAMPLE: The atomic weight of Carbon is 12 therefore the molar mass of Carbon is 12 grams. Conversely, one mole of carbon equals the amount of carbon atoms that weighs 12 grams.<br>Atomic weights can be found on any Periodic Table of Elements. |
| NDIR                 | <i>Non-Dispersive Infrared</i>                                                                                                                                                                                                                                                                                                                                                                                                                                             |
| NIST-SRM             | <i>National Institute of Standards and Technology - Standard Reference Material</i>                                                                                                                                                                                                                                                                                                                                                                                        |
| PC                   | <i>Personal Computer</i>                                                                                                                                                                                                                                                                                                                                                                                                                                                   |
| PCA                  | <i>Printed Circuit Assembly</i> , the PCB with electronic components, ready to use                                                                                                                                                                                                                                                                                                                                                                                         |
| PC/AT                | <i>Personal Computer / Advanced Technology</i>                                                                                                                                                                                                                                                                                                                                                                                                                             |
| PCB                  | <i>Printed Circuit Board</i> , the bare board without electronic component                                                                                                                                                                                                                                                                                                                                                                                                 |
| PFA                  | <i>Per-Fluoro-Alkoxy</i> , an inert polymer; one of the polymers that <i>Du Pont</i> markets as <i>Teflon</i> <sup>®</sup>                                                                                                                                                                                                                                                                                                                                                 |
| PLC                  | <i>Programmable Logic Controller</i> , a device that is used to control instruments based on a logic level signal coming from the instrument                                                                                                                                                                                                                                                                                                                               |
| PLD                  | <i>Programmable Logic Device</i>                                                                                                                                                                                                                                                                                                                                                                                                                                           |

| TERM        | DESCRIPTION/DEFINITION                                                                                                                                                                                    |
|-------------|-----------------------------------------------------------------------------------------------------------------------------------------------------------------------------------------------------------|
| PLL         | <i>Phase Lock Loop</i>                                                                                                                                                                                    |
| PMT         | <i>Photo Multiplier Tube</i> , a vacuum tube of electrodes that multiply electrons collected and charged to create a detectable current signal                                                            |
| P/N (or PN) | <i>Part Number</i>                                                                                                                                                                                        |
| PSD         | <i>Prevention of Significant Deterioration</i>                                                                                                                                                            |
| PTFE        | <i>Poly-Tetra-Fluoro-Ethylene</i> , a very inert polymer material used to handle gases that may react on other surfaces; one of the polymers that <i>Du Pont</i> markets as <i>Teflon</i> <sup>®</sup>    |
| PVC         | <i>Poly Vinyl Chloride</i> , a polymer used for downstream tubing                                                                                                                                         |
| Rdg         | Reading                                                                                                                                                                                                   |
| RS-232      | specification and standard describing a serial communication method between DTE (Data Terminal Equipment) and DCE (Data Circuit-terminating Equipment) devices, using a maximum cable-length of 50 feet   |
| RS-485      | specification and standard describing a binary serial communication method among multiple devices at a data rate faster than RS-232 with a much longer distance between the host and the furthest device  |
| SAROAD      | <i>Storage and Retrieval of Aerometric Data</i>                                                                                                                                                           |
| SLAMS       | <i>State and Local Air Monitoring Network Plan</i>                                                                                                                                                        |
| SLPM        | <i>Standard Liters Per Minute</i> of a gas at standard temperature and pressure                                                                                                                           |
| STP         | <i>Standard Temperature and Pressure</i>                                                                                                                                                                  |
| TCP/IP      | <i>Transfer Control Protocol / Internet Protocol</i> , the standard communications protocol for Ethernet devices                                                                                          |
| TEC         | <i>Thermal Electric Cooler</i>                                                                                                                                                                            |
| TPC         | <i>Temperature/Pressure Compensation</i>                                                                                                                                                                  |
| USB         | <i>Universal Serial Bus</i> : a standard connection method to establish communication between peripheral devices and a host controller, such as a mouse and/or keyboard and a personal computer or laptop |
| VARS        | <i>Variables</i> , the variable settings of the instrument                                                                                                                                                |
| V-F         | <i>Voltage-to-Frequency</i>                                                                                                                                                                               |
| Z/S         | <i>Zero / Span</i>                                                                                                                                                                                        |

# Appendix: Interconnect Diagram

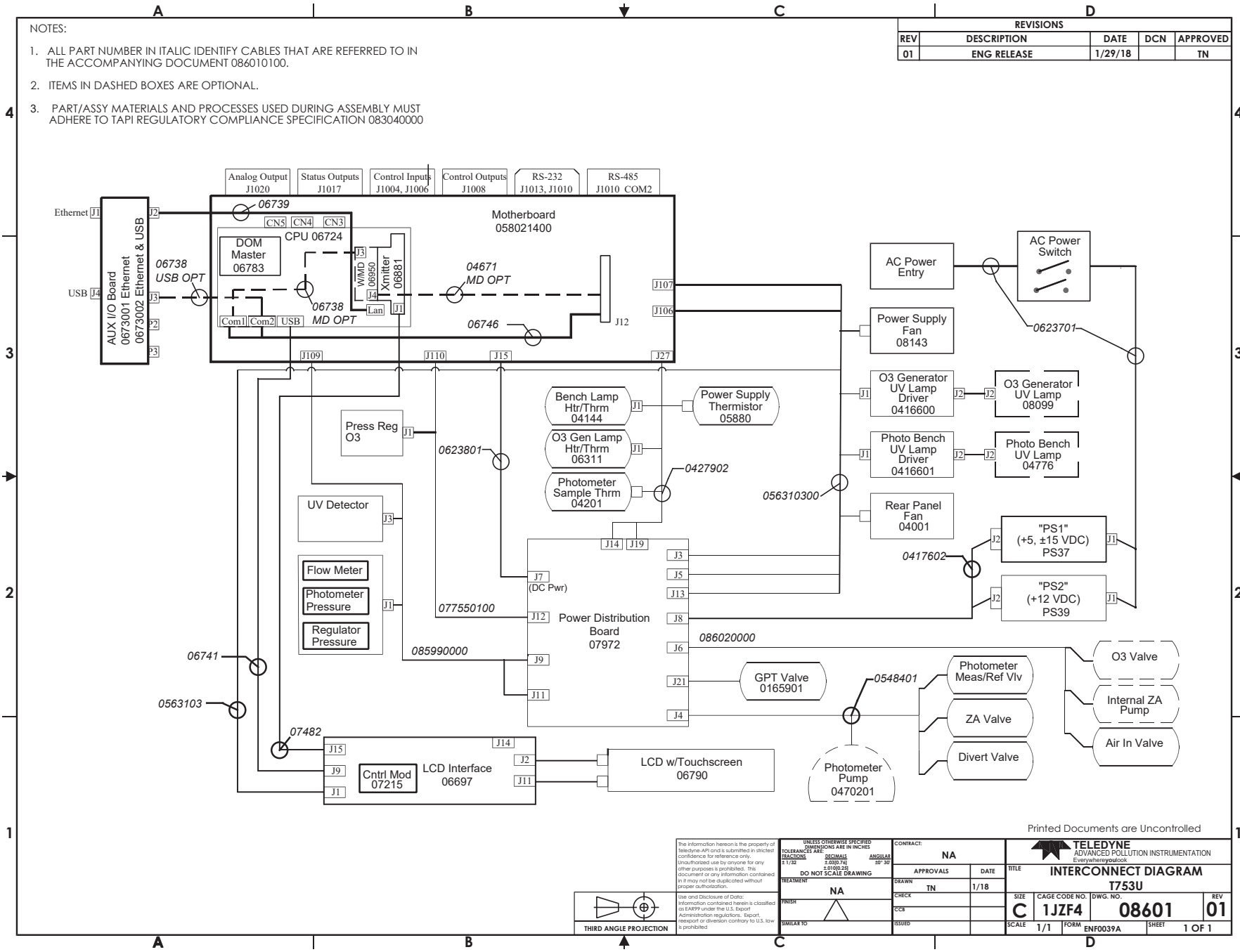

Printed Documents are Uncontrolled

|                                                                                                                                                                                                                                                                                                                                                                                                                                                                                                                                 |                                                                                                                                                      |                                                                            |
|---------------------------------------------------------------------------------------------------------------------------------------------------------------------------------------------------------------------------------------------------------------------------------------------------------------------------------------------------------------------------------------------------------------------------------------------------------------------------------------------------------------------------------|------------------------------------------------------------------------------------------------------------------------------------------------------|----------------------------------------------------------------------------|
| <small>The information herein is the property of Teledyne-API and is submitted in strictest confidence for reference only. Unauthorized use by anyone for any other purposes is prohibited. This document or any information contained in it may not be duplicated without proper authorization.</small><br><small>Use and Disclosure of Data: Information contained herein is classified as EAR99 under the U.S. Export Administration regulations. Export, transport or diversion contrary to U.S. law is prohibited.</small> | <small>UNLESS OTHERWISE SPECIFIED DIMENSIONS ARE IN INCHES</small><br><b>TOLERANCES ARE:</b><br>FRACTIONS DECIMALS ANGULAR<br>± 1/32 ± 0.0075 ± 0.5° | CONTRACT: NA<br>APPROVALS: TN<br>DATE: 1/18<br>TITLE: INTERCONNECT DIAGRAM |
|                                                                                                                                                                                                                                                                                                                                                                                                                                                                                                                                 | TREATMENT: NA<br>FINISH: CCR<br>SIMILAR NO:                                                                                                          | DRAWN: TN<br>CHECK: CCR<br>ISSUED:                                         |
| THIRD ANGLE PROJECTION                                                                                                                                                                                                                                                                                                                                                                                                                                                                                                          | SCALE: 1/1                                                                                                                                           | SHEET: 1 OF 1                                                              |